

# AlazarTech

## ATS9870 User Manual

8 Bit, 1 GS/s  
Waveform Digitizer for PCI Express Bus

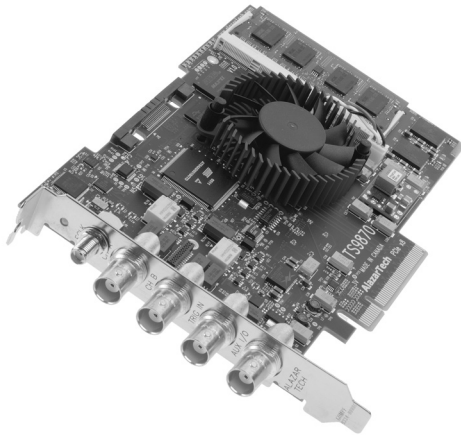

Written for Hardware Version 1.2  
July 2009 Edition  
Part Number: 9870-USR-1



Copyright © 2009 AlazarTech. All rights reserved.

### **AlazarTech Contact Information**

AlazarTech, Inc.  
6600 Trans-Canada Highway  
Suite 310  
Pointe-Claire, QC  
Canada H9R 4S2

Telephone: (514) 426-4899  
Fax: (514) 426-2723

E-mail: [info@alazartech.com](mailto:info@alazartech.com)  
Web site: [www.alazartech.com](http://www.alazartech.com)

To comment on the documentation for ATS9870, send e-mail to [support@alazartech.com](mailto:support@alazartech.com).

Information required when contacting AlazarTech for technical support:

Owned by: \_\_\_\_\_

Serial Number: \_\_\_\_\_

Purchase Date: \_\_\_\_\_

Purchased From: \_\_\_\_\_

Software Driver Version: \_\_\_\_\_

SDK Version: \_\_\_\_\_

AlazarDSO Version: \_\_\_\_\_

Operating System: \_\_\_\_\_

# Important Information

---

## Warranty

The ATS9870 is warranted against defects in materials and workmanship for a period of one year from the date of shipment, as evidenced by receipts or other documentation. AlazarTech, Inc. will, at its option, repair or replace equipment that proves to be defective during the warranty period. This warranty includes parts and labor.

The media on which you receive AlazarTech, Inc. software are warranted not to fail to execute programming instructions, due to defects in materials and workmanship, for a period of 90 days from date of shipment, as evidenced by receipts or other documentation. AlazarTech, Inc. will, at its option, repair or replace software media that do not execute programming instructions if AlazarTech, Inc. receives notice of such defects during the warranty period. AlazarTech, Inc. does not warrant that the operation of the software shall be uninterrupted or error free.

A Return Material Authorization (RMA) number must be obtained from the factory and clearly marked on the outside of the package before any equipment will be accepted for warranty work. AlazarTech, Inc. will pay the shipping costs of returning to the owner parts that are covered by warranty.

AlazarTech, Inc. believes that the information in this document is accurate. The document has been carefully reviewed for technical accuracy. In the event that technical or typographical errors exist, AlazarTech, Inc. reserves the right to make changes to subsequent editions of this document without prior notice to holders of this edition. AlazarTech, Inc. may also make improvements and/or changes in the products and/or programs described in this document at any time. The reader should consult AlazarTech, Inc. if errors are suspected. In no event shall AlazarTech, Inc. be liable for any damages arising out of or related to this document or the information contained in it. The latest user manual can be found on the AlazarTech, Inc. web page at [www.alazartech.com/support/downloads.htm](http://www.alazartech.com/support/downloads.htm).

EXCEPT AS SPECIFIED HEREIN, ALAZARTECH, INC. MAKES NO WARRANTIES, EXPRESS OR IMPLIED, AND SPECIFICALLY DISCLAIMS ANY WARRANTY OF MERCHANTABILITY OR FITNESS FOR A PARTICULAR PURPOSE. CUSTOMER'S RIGHT TO RECOVER DAMAGES CAUSED BY FAULT OR NEGLIGENCE ON THE PART OF ALAZARTECH, INC. SHALL BE LIMITED TO THE AMOUNT THERETOFORE PAID BY THE CUSTOMER. ALAZARTECH, INC. WILL NOT BE LIABLE FOR DAMAGES RESULTING FROM LOSS OF DATA, PROFITS, USE OF PRODUCTS, OR INCIDENTAL OR CONSEQUENTIAL DAMAGES, EVEN IF ADVISED OF THE POSSIBILITY THEREOF. This limitation of the liability of AlazarTech, Inc. will apply regardless of the form of action, whether in contract or tort, including negligence. Any action against AlazarTech, Inc. must be brought within one year after the cause of action accrues. AlazarTech, Inc. shall not be liable for any delay in performance due to causes beyond its reasonable control. The warranty provided herein does not cover damages, defects, malfunctions, or service failures caused by owner's failure to follow the AlazarTech, Inc. installation, operation, or maintenance instructions; owner's modification of the product; owner's abuse, misuse, or negligent acts; and power failure or surges, fire, flood, accident, actions of third parties, or other events outside reasonable control.

## Copyright

Under the copyright laws, this publication may not be reproduced or transmitted in any form, electronic or mechanical, including photocopying, recording, storing in an information retrieval system, or translating, in whole or in part, without the prior written consent of AlazarTech, Inc.

## Trademarks

AlazarTech, Inc.™, AlazarTech™, alazartech.com™, ATS™, ATS9870™, AlazarDSO™, are trademarks of AlazarTech, Inc. Product and company names mentioned herein are trademarks or trade names of their respective companies.

## **Warning Regarding Use of AlazarTech Products**

1. ALAZARTECH, INC. PRODUCTS ARE NOT DESIGNED WITH COMPONENTS AND TESTING FOR A LEVEL OF RELIABILITY SUITABLE FOR USE IN OR IN CONNECTION WITH SURGICAL IMPLANTS OR AS CRITICAL COMPONENTS IN ANY LIFE SUPPORT SYSTEMS WHOSE FAILURE TO PERFORM CAN REASONABLY BE EXPECTED TO CAUSE SIGNIFICANT INJURY TO A HUMAN.
2. IN ANY APPLICATION, INCLUDING THE ABOVE, RELIABILITY OF OPERATION OF THE SOFTWARE PRODUCTS CAN BE IMPAIRED BY ADVERSE FACTORS, INCLUDING BUT NOT LIMITED TO FLUCTUATIONS IN ELECTRICAL POWER SUPPLY, COMPUTER HARDWARE MALFUNCTIONS, COMPUTER OPERATING SYSTEM SOFTWARE FITNESS, FITNESS OF COMPILERS AND DEVELOPMENT SOFTWARE USED TO DEVELOP AN APPLICATION, INSTALLATION ERRORS, SOFTWARE AND HARDWARE COMPATIBILITY PROBLEMS, MALFUNCTIONS OR FAILURES OF ELECTRONIC MONITORING OR CONTROL DEVICES, TRANSIENT FAILURES OF ELECTRONIC SYSTEMS (HARDWARE AND/OR SOFTWARE), UNANTICIPATED USES OR MISUSES, OR ERRORS ON THE PART OF THE USER OR APPLICATIONS DESIGNER (ADVERSE FACTORS SUCH AS THESE ARE HEREAFTER COLLECTIVELY TERMED "SYSTEM FAILURES"). ANY APPLICATION WHERE A SYSTEM FAILURE WOULD CREATE A RISK OF HARM TO PROPERTY OR PERSONS (INCLUDING THE RISK OF BODILY INJURY AND DEATH) SHOULD NOT BE RELIANT SOLELY UPON ONE FORM OF ELECTRONIC SYSTEM DUE TO THE RISK OF SYSTEM FAILURE. TO AVOID DAMAGE, INJURY, OR DEATH, THE USER OR APPLICATION DESIGNER MUST TAKE REASONABLY PRUDENT STEPS TO PROTECT AGAINST SYSTEM FAILURES, INCLUDING BUT NOT LIMITED TO BACK-UP OR SHUT DOWN MECHANISMS. BECAUSE EACH END-USER SYSTEM IS CUSTOMIZED AND DIFFERS FROM ALAZARTECH, INC.'S TESTING PLATFORMS AND BECAUSE A USER OR APPLICATION DESIGNER MAY USE ALAZARTECH, INC. PRODUCTS IN COMBINATION WITH OTHER PRODUCTS IN A MANNER NOT EVALUATED OR CONTEMPLATED BY ALAZARTECH, INC., THE USER OR APPLICATION DESIGNER IS ULTIMATELY RESPONSIBLE FOR VERIFYING AND VALIDATING THE SUITABILITY OF ALAZARTECH INC. PRODUCTS WHENEVER ALAZARTECH, INC. PRODUCTS ARE INCORPORATED IN A SYSTEM OR APPLICATION, INCLUDING, WITHOUT LIMITATION, THE APPROPRIATE DESIGN, PROCESS AND SAFETY LEVEL OF SUCH SYSTEM OR APPLICATION.

# Compliance

---

## FCC/Canada Radio Frequency Interference Compliance\*

### Determining FCC Class

The Federal Communications Commission (FCC) has rules to protect wireless communications from interference. The FCC places digital electronics into two classes. These classes are known as Class A (for use in industrial-commercial locations only) or Class B (for use in residential or commercial locations). Depending on where it is operated, this product could be subject to restrictions in the FCC rules. (In Canada, the Department of communications (DOC), of Industry Canada, regulates wireless interference in much the same way.)

Digital electronics emit weak signals during normal operation that can affect radio, television, or other wireless products. By examining the product you purchased, you can determine the FCC Class and therefore which of the two FCC/DOC Warnings apply in the following sections. (Some products may not be labeled at all for FCC; if so, the reader should then assume these are Class A devices.)

FCC Class A products only display a simple warning statement of one paragraph in length regarding interference and undesired operation. Most of our products are FCC Class A. The FCC rules have restrictions regarding the locations where FCC Class A products can be operated.

FCC Class B products display either a FCC ID code, starting with the letters **EXN**, or the FCC Class B compliance mark.

Consult the FCC web site <http://www.fcc.gov> for more information.

### FCC/DOC Warnings

This equipment generates and uses radio frequency energy and, if not installed and used in strict accordance with the instructions in this manual and the CE Mark Declaration of Conformity\*\*, may cause interference to radio and television reception. Classification requirements are the same for the Federal Communications Commission (FCC) and the Canadian Department of Communications (DOC).

Changes or modifications not expressly approved by AlazarTech Inc. could void the user's authority to operate the equipment under the FCC Rules.

### Class A

#### Federal Communications Commission

This equipment has been tested and found to comply with the limits for a Class A digital device, pursuant to part 15 of the FCC Rules. These limits are designed to provide reasonable protection against harmful interference when the equipment is operated in a commercial environment. This equipment generates, uses, and can radiate radio frequency energy and, if not installed and used in accordance with the instruction manual, may cause harmful interference to radio communications. Operation of this equipment in a residential area is likely to cause harmful interference in which case the user will be required to correct the interference at his own expense.

#### Canadian Department of Communications

This Class A digital apparatus meets all requirements of the Canadian Interference-Causing Equipment Regulations. *Cet appareil numérique de la classe A respecte toutes les exigences du Règlement sur le matériel brouilleur du Canada.*

## Compliance to EU Directives

Readers in the European Union (EU) must refer to the Manufacturer's Declaration of Conformity (DoC) for information\*\* pertaining to the CE Mark compliance scheme. The Manufacturer includes a DoC for most every hardware product except for those bought for OEMs, if also available from an original manufacturer that also markets in the EU, or where compliance is not required as for electrically benign apparatus or cables.

To obtain the DoC for this product, click **Declaration of Conformity** at <http://www.alazartech.com/support/documents.htm>. This web page lists all DoCs by product family. Select the appropriate product to download or read the DoC.

- \* Certain exemptions may apply in the USA, see FCC Rules §15.103 **Exempted devices**, and §15.105(c). Also available in sections of CFR 47.
- \*\* The CE Mark Declaration of Conformity will contain important supplementary information and instructions for the user or installer.

## Environmental Compliance

Alazar Technologies Inc., hereby certifies that this product is RoHS compliant, as defined by *Directive 2002/95/EC of the European Parliament and of the Council of 27 January 2003 on the restriction of the use of certain hazardous substances in electrical and electronic equipment*. All manufacturing has been done using RoHS-compliant components and lead-free soldering.

# Table of Contents

---

<b>CHAPTER 1 - INTRODUCTION</b> .....	<b>1</b>
About Your ATS9870.....	2
Acquiring Data with Your ATS9870.....	4
Optional Upgrades.....	8
<b>CHAPTER 2 - INSTALLATION AND CONFIGURATION</b> .....	<b>9</b>
What You Need to Get Started.....	10
Unpacking.....	11
Installing the ATS9870.....	12
Installing the ATS9870 in a Linux System.....	25
Compiling the ATS9870 Linux Driver.....	26
Updating ATS9870 Driver.....	27
<b>CHAPTER 3 - HARDWARE OVERVIEW</b> .....	<b>29</b>
Input Connectors.....	31
Signal Connections.....	32
Analog Input.....	33
Calibration.....	35
Optional External Clock.....	36
Streaming Data Across the Bus.....	38
<b>APPENDIX A - SPECIFICATIONS</b> .....	<b>49</b>
<b>APPENDIX B - BENCHMARKS</b> .....	<b>54</b>



# Chapter 1 - Introduction

---

This chapter describes the ATS9870 and lists additional equipment.

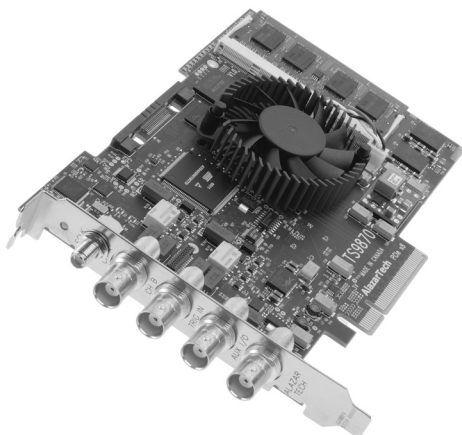

## About Your ATS9870

---

Thank you for your purchase of an ATS9870. This PCI Express (PCIe x8) based waveform digitizer has the following features:

- Two 8-bit resolution analog input channels
- Real-time sampling rate of 1 GS/s to 1 KS/s
- On-board acquisition memory buffer of up to 4 Gigabytes
- Streaming of acquired data to PC host memory at 1.4 GB/s (exact rate is motherboard dependent)
- 450 MHz analog input bandwidth
- Half length PCI Express (8 lane) card
- Analog trigger channel with software-selectable level and slope
- Software-selectable AC/DC coupling and fixed 50 $\Omega$  input impedance
- Software-selectable bandwidth limit switch, independent for each channel
- Pre-trigger and Post-Trigger Capture with Multiple Record capability
- NIST traceable calibration
- Dual DMA engines for best latency protection against Windows and Linux operating systems
- Fully asynchronous software driver for fastest DMA with least CPU overhead

All ATS9870 digitizers follow industry-standard Plug and Play specifications on all platforms and offer seamless integration with compliant systems.

If your application requires more than two channels for data acquisition, you can synchronize multiple digitizers on all platforms using a Master/Slave SyncBoard 9870.

Detailed specifications of the ATS9870 digitizers are listed in Appendix A, Specifications.

## **Acquiring Data with Your ATS9870**

---

You can acquire data either programmatically by writing an application for your ATS9870 or interactively with the AlazarDSO software.

If you want to integrate the ATS9870 in your test and measurement or embedded OEM application, you can program the digitizer using C/C++, Visual BASIC or LabVIEW for Windows or C for Linux operating systems.

- Windows operating systems supported are Windows Vista 32 bit, Windows Vista 64 bit, Windows XP 32 bit and Windows XP 64 bit
- Note that Windows 98SE and Windows 2000 are not supported.

For programming in C/C++ or Visual BASIC, you must purchase the ATS-SDK software development kit that comes with sample programs and a reference manual describing the API.

For programming in LabVIEW, you must purchase the ATS-VI virtual instrument library that comes with a high-level, easy-to-use VI that makes integrating the ATS9870 into your own system very simple.

With the recent release of Linux drivers for ATS9870, it is possible to program your ATS9870 under Linux operating system. You will need to sign a Non-Disclosure Agreement with AlazarTech and purchase the ATS-Linux software development kit that comes with source files for the driver (Fedora Core 9 - kernel 2.6) and C source code for a sample program. Also supplied is the AlazarFrontPanel graphical user interface for the ATS9870.

## Interactively Controlling your ATS9870 with AlazarDSO

The AlazarDSO oscilloscope emulation software allows you to interactively control your ATS9870 as you would a desktop oscilloscope. To launch the AlazarDSO program, select

### Start » Programs » AlazarTech » AlazarDSO

The following screen will be displayed. If you connect the input to a signal generator and click on **Start** button, you should see the signal on the screen.

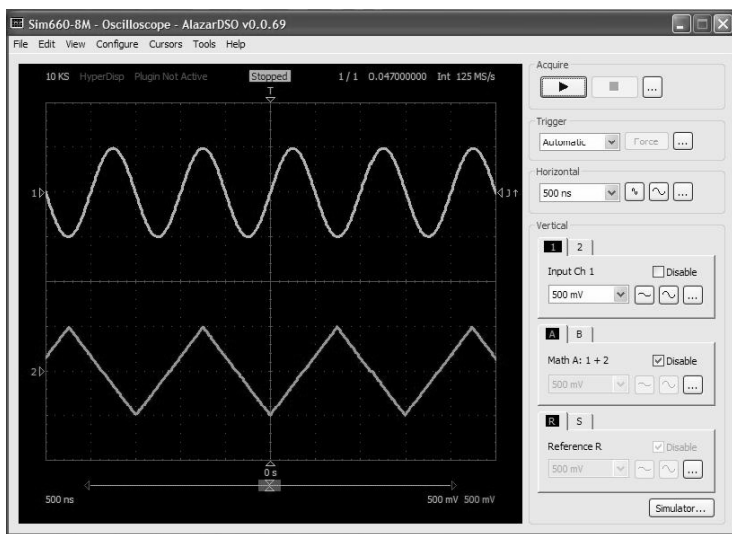

AlazarDSO has been designed to be very intuitive and uses a user interface similar to most of today's digital oscilloscopes.

## ATS-SDK API

The ATS-SDK API is used for programming the ATS9870 in C/C++ or Visual BASIC. It provides the exact same API that is used for writing AlazarDSO software. To help you get started, ATS-SDK comes with examples you can use or modify.

Note that Synchronous DMA functions cannot be used with the ATS9870.

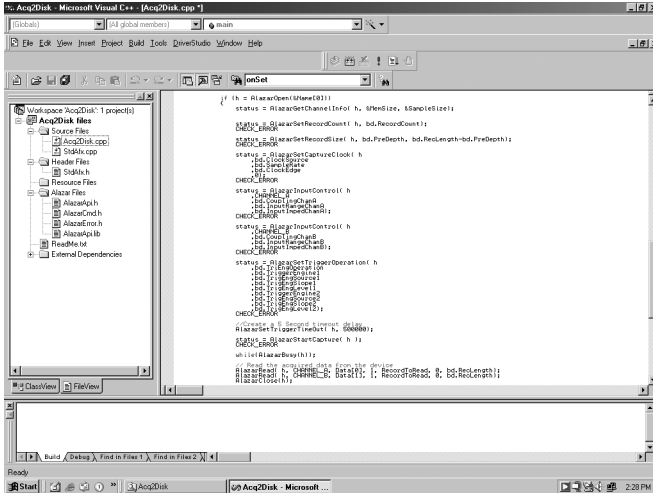

## ATS-VI LabVIEW VI

ATS-VI allows you to integrate the ATS9870 into your own LabVIEW program. A high level VI is supplied that requires very few controls to get started.

Note that Synchronous DMA vi's cannot be used with the ATS9870.

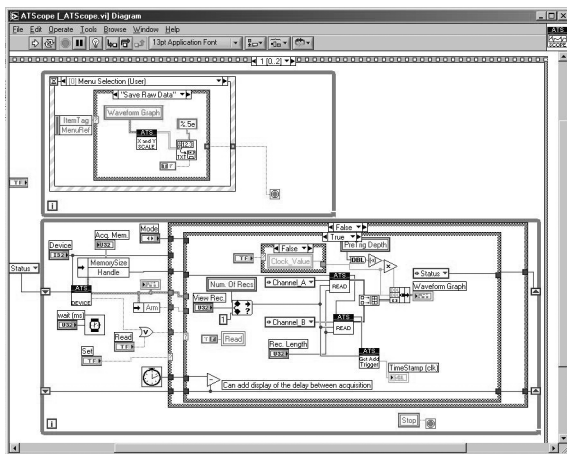

## ATS-Linux for ATS9870

The ATS-Linux for ATS9870 can be used for programming the ATS9870 under Linux operating system. A source code driver is supplied that has been compiled for Fedora Core 9 (Kernel 2.6) running on an i386 platform. Sample program is supplied in C. The API is identical to the Windows API.

Note that you will need to sign a Non-Disclosure Agreement with AlazarTech in order for the source code of the drivers to be shared with you.

## Optional Upgrades

---

AlazarTech offers the following upgrades and accessories for use with your ATS9870 digitizer:

- ATS9870: External Clock Upgrade
- ATS9870: Master/Slave SyncBoard      2 position
- ATS9870: Master/Slave SyncBoard      4 position
- ATS9870: Master/Slave SyncBoard      8 position
- AlazarDSO – Stream To Disk Module
- AlazarDSO – Plug-In Development Kit



# **Chapter 2 - Installation and Configuration**

---

This chapter describes how to unpack, install, and configure your ATS9870.

# What You Need to Get Started

---

To set up and use your ATS9870, you will need the following:

- One or more ATS9870 digitizers

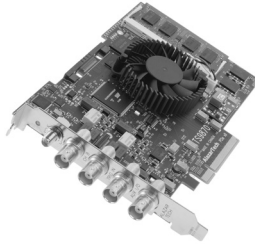

- ATS9870 Install Disk



- For Master/Slave operation only:  
SyncBoard of appropriate width

## Unpacking

---

Your digitizer is shipped in an antistatic package to prevent electrostatic damage to the digitizer. Electrostatic discharge can damage several components on the digitizer. To avoid such damage in handling the digitizer, take the following precautions:

- Ground yourself via a grounding strap or by holding a grounded object.
- Touch the antistatic package to a metal part of your computer chassis before removing the digitizer from the package.
- Remove the digitizer from the package and inspect the digitizer for loose components or any other sign of damage. Notify AlazarTech if the digitizer appears damaged in any way. Do *not* install a damaged digitizer into your computer.
- *Never* touch the exposed pins of the connectors.

# Installing the ATS9870

---

There are four main steps involved in installation:

1. Physically install the digitizer(s) and SyncBoard, if any, in your computer.
2. Install ATS9870 software driver
3. Install AlazarDSO software that allows you to setup the hardware, acquire signals and view and archive them
4. Optionally, install the ATS-SDK software development kit or ATS-VI LabVIEW VI, which enables you to programmatically control the ATS9870

Thanks to the flexible nature of AlazarTech's driver installation software, you can either install the hardware first or install the software driver first.

The following paragraphs will guide you through this process in a step-by-step manner.

## 1. **Physically install the digitizer in your computer**

Identify an unused PCI Express slot on your motherboard. As per PCI Express specification, the 8-lane ATS9870 card is compatible with any 8-lane or 16-lane connector on the motherboard.

Make sure that your computer is powered off before you attempt to insert the ATS9870 digitizer in one of the free PCI Express slots.

For best noise performance, leave as much room as possible between your ATS9870 and other hardware.

Always screw the digitizer bracket to the chassis in order to create a stable and robust connection to chassis ground.

In the absence of such a connection, ATS9870 is not guaranteed to operate within the specifications listed elsewhere in this manual.

Some motherboards may have a 16-lane connector, but only one of the lanes is connected to the motherboard chipset. Motherboard manufacturers refer to this as “Mechanically 16-lane, electrically 1 lane”. ATS9870 is fully compatible with such motherboards, but the data throughput across PCI Express bus will be limited by the number of lanes.

## 2. **For Master/Slave Installation**

If you are installing multiple ATS9870 digitizers that will be configured as a Master/Slave system, make sure that you insert all cards in adjacent slots.

The connector on the SyncBoard that is labeled as "M" (Master), must be inserted into the Master/Slave connector of the left-most digitizer, if you are facing the BNC connectors of the ATS9870 digitizers.

If you are installing fewer than the maximum number of digitizers supported by your SyncBoard, the unused SyncBoard connectors must be on the right-hand side of the digitizers, if you are facing the BNC connectors of the ATS9870 digitizers.

Once you have completed this step, you should power the computer on.

### 3. **Install ATS9870 software driver**

The following instructions guide you through the process of installing the ATS9870 in a computer running Windows Vista or Windows XP operating systems.

Other operating systems, such as Windows NT, Windows 2000, Windows 95 and Windows 98SE are not covered here.

Note that the images of the dialog boxes shown below were taken from a Windows XP computer. Computers running Vista may have slightly different dialog boxes.

#### **Installation of Multiple ATS9870 Digitizers**

If you are installing multiple ATS9870 digitizers, the operating system will detect one card at a time and you will have to go through the driver installation setup as many times as you have cards.

## **Installing ATS9870 Hardware First**

If you decided to install the ATS9870 hardware before installing the ATS9870 software driver, then when you first boot up the computer, the plug-n-play Windows operating system will detect the presence of a new PCI card and ask you to provide the device driver.

- a) When you power on for the first time, Windows will display the **Welcome to the Found New Hardware Wizard**



Click **Cancel**.



- b) Insert the installation CD. If it does not auto-run, manually run the Setup.exe program on the ATS9870 Driver Disk.



Click **Next**.

- c) The following dialog box will be displayed showing the progress of installation of ATS9870 driver files in the operating system driver store.



- a) The following final screen will confirm that the driver has been installed.



Now your ATS9870 is fully installed and is ready to use.

## **Installing ATS9870 Driver First**

If you decided to install the ATS9870 software driver before installing the ATS9870 hardware, then you must follow the following sequence to make sure your operating system recognizes ATS9870 as an installed device.

- b) Insert the installation CD. If it does not auto-run, manually run the Setup.exe program on the ATS9870 Driver Disk.



Click **Next**.

- c) The following dialog box will be displayed showing the progress of installation of ATS9870 driver files in the operating system driver store.

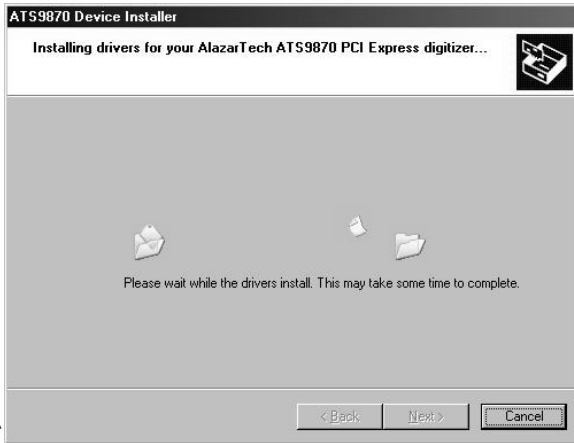

- d) The following final screen will confirm that the driver has been installed.



- e) Click **Finish** and power down your computer
- f) Physically install your ATS9870 card(s).

If you are installing a Master/Slave system, also install the SyncBoard.

- g) Power on your computer
- h) Windows will display the **Welcome to the Found New Hardware Wizard**



Click **Next**

- i) The following dialog box will be displayed:



- j) Choose to install the software automatically. Click **Next**

Operating system will copy the appropriate files to its system folders. The following dialog box will be displayed:



- k) Operating system will display the **Completing the Found New Hardware Wizard** message.



Click **Finish**. Now your ATS9870 is fully installed and is ready to use.

3. **Install AlazarDSO software that allows you to setup the hardware, acquire signals and view and archive them**

If you are installing from the CD shipped with the ATS9870 digitizer:

- Insert the ATS9870 Install disk
- Use Windows Explorer to navigate to the AlazarDSO folder on the ATS9870 Install Disk. Run Setup.exe program
- Follow the instructions on the screen.

If you are installing AlazarDSO after having downloaded the installation file from AlazarTech web site:

- Download AlazarDSO installation file from [www.alazartech.com/support/downloads.htm](http://www.alazartech.com/support/downloads.htm)
- Unzip the file downloaded in the previous step.
- Browse to the folder that contains the unzipped file, Setup.exe
- Run this executable file and follow the instructions on the screen.

4. **Optionally, install the ATS-SDK software development kit or ATS-VI LabVIEW VI, which enables you to programmatically control the ATS9870**

Insert the ATS-SDK or ATS-VI CD. Software installation will start automatically.

If, for any reason, installation does not start automatically, run the SETUP.EXE program.

Follow the instructions on the screen.

Note that you must have already installed the ATS9870 drivers for any of the sample programs included with the ATS-SDK or ATS-VI to work properly.



## **Installing the ATS9870 in a Linux System**

ATS9870 is fully compatible with the popular Linux operating system.

AlazarTech supplies source code Linux drivers that have been tested under Fedora Core 10 (kernel 2.6).

- Note that a Non-Disclosure Agreement must be signed between AlazarTech and your company or university before any source code can be released to you.

AlazarTech does not provide software support for compiling drivers for other versions of Linux, i.e. customers will be fully responsible for compiling drivers for their own Linux operating system.

To install Linux drivers in a Fedora Core 10 system, follow the instructions listed below:

1. Copy the supplied RPM file to the target machine
2. Double-click on the RPM icon. This will install the driver as well as associated applications.
3. Reboot the PC.  
Note that if you do not reboot the PC, the driver will not be loaded.

The RPM file will also install an application called AlazarFrontPanel. This is a Graphical User Interface (GUI) using which you can setup and acquire data from the ATS9870.

Note that AlazarFrontPanel has been compiled using GTK 2.4 libraries. If you intend to use an operating system other than Fedora Core 10, make sure that the GTK 2.4 libraries have been installed on your machine.

- 1.

## Compiling the ATS9870 Linux Driver

---

If you need to compile the ATS9870 driver for a version of Linux other than Fedora Core 10, follow these steps:

2. Install the Linux kernel header files.
3. Extract the driver sources using the command "PlxLinux\_ATS9870\_5.6.15.tgz". This will create a folder names "PlxLinux" with the driver files inside.
4. Set the shell environment variable PLX\_SDK\_DIR to the root location where the "PlxLinux" directory was created. For example, if using bash and the PlxLinux directory is in your home directory, then add the following line to the ~/.bashrc :

```
declare -x PLX_SDK_DIR=$HOME/PlxLinux
```

5. To build the ATS9870 driver, type

```
cd PlxLinux/linux/driver
./make
```

This will create the file ATS9870.ko, the loadable driver file. You can change build defines in PlxLinux/linux/makefiles/Gcc.def. Copy the driver to /usr/local/AlazarTech/bin.

6. Load the driver by rebooting the computer or typing:

```
cd /usr/local/AlazarTech/bin
ATS9870.rc start
```

The customer should be able to run the AlazarFrontPanel application or Acq2Disk sample in /usr/local/AlazarTech/samples.

7. If it is necessary to rebuild the library, type

```
cd PlxLinux/linux/api
make
```

This will create SharedLibrary/libPlxApi.so.0.0. Copy the file to /usr/local/AlazarTech/lib and then run ldconf

## Updating ATS9870 Driver

---

From time to time, AlazarTech updates the device drivers for its products. These updates may be required for product enhancements or for bug fixes.

This section of the manual takes you through the steps required to update the device driver for the ATS9870 PCI Express waveform digitizer.

In other words, this section shows you how to install a newer version of the driver, when you already have a previous version of the driver installed on your machine.

1. Download the latest driver from AlazarTech's web site:  
[www.alazartech.com/support/downloads.htm](http://www.alazartech.com/support/downloads.htm)
2. Unzip the downloaded file to a local folder
3. Run the resulting installation file (\*.exe extension). For example, the installation file for driver version 5.8.0 is called **ATS9870\_Driver\_V5.8.0.exe**.

The following welcome screen will be displayed:



Click **Next**.

4. The following dialog box will be displayed showing the progress of installation of ATS9870 driver files.



5. The following final screen will confirm that the driver has been installed.



- a. Click **Finish**.

ATS9870 driver has now been updated

# Chapter 3 - Hardware Overview

---

This chapter includes an overview of the ATS9870, explains the operation of each functional unit making up your ATS9870, and describes the signal connections.

Following is a high-level block diagram of ATS9870.

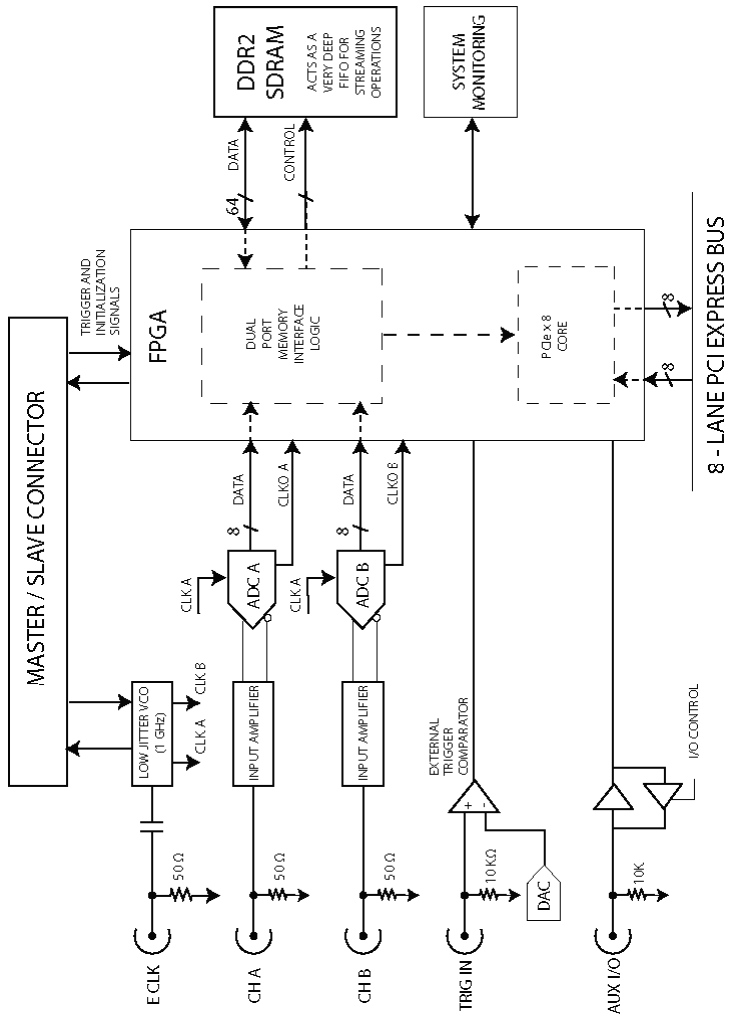

## Input Connectors

---

ATS9870 digitizers have one SMA connector for ECLK (External Clock) Input, two standard BNC female connectors for CH A and CH B analog input connections, one standard BNC female connector for the TRIG IN (External Trigger) input and one standard BNC female connector for AUX I/O (Auxiliary Input or Output).

The following pictorial shows the various connectors available on the digitizer bracket.

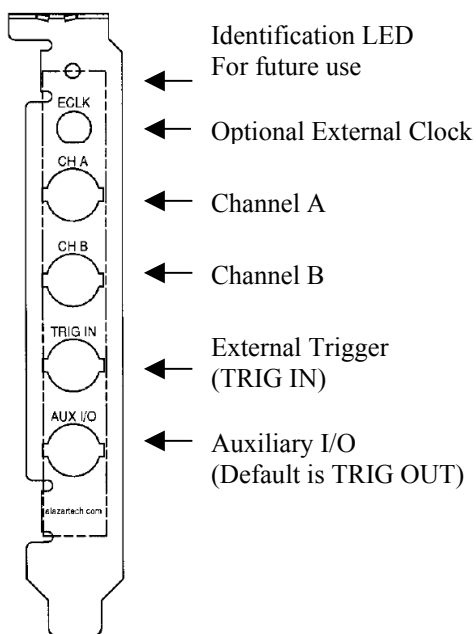

## Signal Connections

---

You can use CH A and CH B to digitize data as well as to trigger an acquisition.

Use the EXT input for an external analog trigger only; data on the TRIG channel cannot be digitized.

If External Clock Upgrade is installed on your ATS9870, use the ECLK input for clocking the ATS9870 in applications that require an external clock. Consult the chapter [Optional External Clock](#) for details on various types of clocking schemes available.

AUX I/O connector can be used for outputting TRIG OUT signal, a 5 V TTL signal synchronous with the on-board trigger signal and the sampling clock.

- Note that the Trigger Output connector can also be configured as a Trigger Enable Input through a software command. Contact factory for details.



## Analog Input

---

The two analog input channels are referenced to common ground in bipolar mode. These settings are fixed; therefore, neither the reference nor the polarity of input channels can be changed. You cannot use CH A or CH B to make differential measurements or measure floating signals unless you subtract the digital waveforms in software.

For accurate measurements, make sure the signal being measured is referenced to the same ground as your ATS9870 by attaching the probe's ground clip to the signal ground.

The EXTERNAL Trigger input (labeled TRIG IN) has a fixed input range of  $\pm 5$  V.

The CH A, CH B, and EXT inputs have a software-programmable coupling selection between AC and DC. Use AC coupling when your AC signal contains a large DC component. Without AC coupling, it is difficult to view details of the AC component with a large DC offset and a small AC component, such as switching noise on a DC supply. If you enable AC coupling, you remove the large DC offset for the input amplifier and amplify only the AC component. This technique makes effective use of dynamic range to digitize the signal of interest.

The *low-frequency corner* in an AC-coupled circuit is the frequency below which signals are attenuated by at least 3 dB. The low-frequency corner is approximately 100 KHz with 50 $\Omega$  input impedance.

### **Dual 8-Bit ADC**

ATS9870 uses a dual flash analog-to-digital converter with a maximum conversion rate of 1 GS/s.

If you use an external clock, you must provide a free-running clock to ensure reliable operation. You also must follow all the timing specifications on the external clock as described in Appendix A, Specifications.

### **Multiple Record Acquisition**

The ATS9870 allows the capture of multiple records into the on-board memory. This allows you to capture rapidly occurring triggers in OCT, ultrasound or radar applications.

Note that ATS9870 allows you to acquire pre-trigger data.

### **Specifying Record Length**

Record Length is specified in number of sample points. It must be a minimum of 256 points and can be specified with a 64-sample resolution.

### **Specifying Pretrigger Depth**

You can acquire pre-trigger data up to the limit of (Record length – 128). Minimum value for pre-trigger amount is 0.

### **Specifying Record Count**

User can specify the number of records that must be captured into host PC memory. The minimum value must be 1.

The maximum Record Count value in single-port mode is 1000.

In dual-port memory mode, there is no upper limit on how many records you can capture in one acquisition.

## Calibration

---

Calibration is the process of minimizing measurement errors by making small circuit adjustments.

All ATS9870 digitizers come factory calibrated to the levels indicated in Appendix A, Specifications. Note that AlazarTech calibration is fully NIST traceable.

However, your digitizer needs to be periodically recalibrated in order to maintain its specified accuracy. This calibration due date is listed on the CALIBRATION sticker affixed to your ATS9870 digitizer.

Externally recalibrate the ATS9870 when this calibration interval has expired.

This requires three very simple steps:

1. Verify whether or not ATS9870 is still within its specifications. If it is, then your calibration can be extended by another one-year period
2. If not, perform calibration, i.e. make adjustments to the circuit until it is within specifications again
3. If any adjustments have been made, verify if the ATS9870 is within specifications

Calibration Verification procedures are available to all registered users of ATS9870 as part of AlazarDSO software.

Calibration software can be purchased by qualified customers and metrology laboratories.

## Optional External Clock

---

ATS9870 PCI Digitizer optionally allows you to supply the ADC clock. This option is extremely important in many RF applications in which phase measurements must be made between the inputs themselves or between the inputs and an external event.

Driving high performance ADCs must be done carefully, as any injection of phase jitter through ADC clocks will result in reduction in data conversion quality.

Aside from phase noise, the clock signal for a pipelined ADC must also have a duty cycle close to 50%. This maximizes the dynamic performance of the ADC. See Fast External Clock section below for more details.

External clock input impedance is fixed at 50 Ohms.

External clock input is always AC-coupled.

There are three types of External Clock supported by ATS9870:

- Fast External Clock
- Slow External Clock
- 10 MHz Clock Reference

The following paragraphs describe the three types of External Clock input and outline the restrictions on each of them.

### **Fast External Clock**

This setting must be used when the external clock frequency is in the range of 200 MHz to 1 GHz.

It is highly recommended that the Fast External Clock signal have a duty cycle of 50% +/- 5%.

If the External Clock supplied is lower than 200 MHz, measurement quality may be compromised. Measurement errors may include gain errors, signal discontinuities and general signal distortion.

If you want to clock slower than the lower limit of Fast External Clock, you must use the Slow External Clock range.

External Clock must be a sine wave signal with amplitude in the range of 100 mV<sub>p-p</sub> to 1 V<sub>p-p</sub>.

### **Slow External Clock**

This setting must be used when the external clock frequency is slower than the lower limit of Fast External Clock.

In this range, the input clock is tracked by the 125 MHz internal clock and a sample is taken on every rising or falling clock edge. As such, there will be a timing error of 0 to 8 nanoseconds. For low bandwidth signals, this error can be considered to be negligible.

Slow External Clock signal must be a 3.3 Volt TTL signal.

### **10 MHz Clock Reference**

ATS9870 allows the user to synchronize the sampling clock to an external 10 MHz reference signal. This is useful in many RF applications.

Reference clock frequency must be 10 MHz +/- 0.5 MHz.

It should be noted that the 10 MHz reference produces a 1 GHz clock. Users can set lower sampling frequency by specifying a decimation value.

Reference clock amplitude can be a sine wave from 100 mV<sub>p-p</sub> to 1 V<sub>p-p</sub> or a 3.3 Volt TTL signal.

## **Streaming Data Across the Bus**

---

One of the most unique features of the ATS9870 is its on-board, dual-port acquisition memory that can act as a very deep Data FIFO and the associated Dual-DMA engine.

This combined by the advanced, fully asynchronous software driver allows data transfer to host PC memory without any appreciable “in-process” software involvement.

These features are particularly useful for applications that require:

a) Continuous, gapless data capture. Also known as “Data Streaming” to PC host memory or hard disk

or

b) Data capture from rapidly occurring triggers, also known as Pulse Repeat Frequency Captures or PRF Captures.

In order to understand these sophisticated features, let us first review some of the issues involved in transferring data under Windows or Linux operating systems.

## **The Effects of the Operating System**

Windows and Linux are not real-time operating systems, i.e. the operating system cannot guarantee a deterministic response time to an event, such as an interrupt or a software generated event.

This means that if software has to play any appreciable part in data transfer, then the data throughput cannot be guaranteed, as the operating system will have the last say as to when the data collection application will get the CPU cycles to execute the necessary commands.

Note that the above is true even if the digitizer claims to use Direct Memory Access (DMA) to do the actual transfer, but uses software commands to re-arm the digitizer. It is the re-arm command that will determine the overall data throughput.

For example, it is very common for PCI digitizers that boast very fast throughput to slow down considerably when capturing pulsed radar or ultrasonic signals at Pulse Repeat Frequency (PRF) of 1 KHz or so, even though each capture is only 2048 bytes (a paltry 2 MB/s throughput).

In other words, digitizers that specify raw data throughput of 100 MB/s can hardly handle 2MB/s effective throughput due to operating system related delays in issuing re-arm commands.

## **Real-Time Operating Systems**

Some vendors claim that switching to a real-time operating system (RTOS) can solve the problems involved in PRF data capture.

Before switching to an expensive RTOS (such as VxWorks, QNX or PharLap ETS), ask the vendor of the operating system, the supplier of your PC system and manufacturer of the digitizer board if they are all guaranteed to be 100% compatible and interoperable with each other with deterministic interrupt latencies and if you will get your money back if the system does not work at your PRF rates with your software.

Here is an excerpt from a FAQ section of one such supplier of RTOS:

Question: How do system configuration and CPU selection impact the interrupt latency?

Answer: Hardware platforms and the configuration of the associated drivers that use the hardware do impact response times. Some of the common issues include:

Video cards - some of the higher-end cards lock-out (or busy-wait) the bus for extended periods of time to improve their performance.

DMA devices - devices which burst DMA for lengthy period.

Power management which cycles off the CPU during IDLE CPU periods.

Memory speeds, processor speeds, etc.

A PCI or PCI Express digitizer being used in a PRF or streaming application is, by definition, doing “burst DMA for lengthy period”, and is a type of product that can negatively impact response times of the RTOS.



As such, the claim that an RTOS can remove all timing uncertainties in PRF application is suspect, to say the least.

Furthermore, you may not be able to get software drivers for the selected RTOS for all the hardware components you need for your system.

In summary, moving to a real-time operating system will not guarantee data throughput, but will surely increase the overall system cost, increase the cost of software development and maintenance and limit the number of suppliers for other hardware components.

### Dual Port Memory

The basic throughput problem faced by digitizers is that almost all of them use single-port memory, i.e. if you are reading data from the acquisition memory, you cannot capture into it and vice-versa.

This requires a software handshake which is heavily dependent on the operating system response time.

### TRIGGERED DATA ACQUISITION USING SINGLE-PORT MEMORY

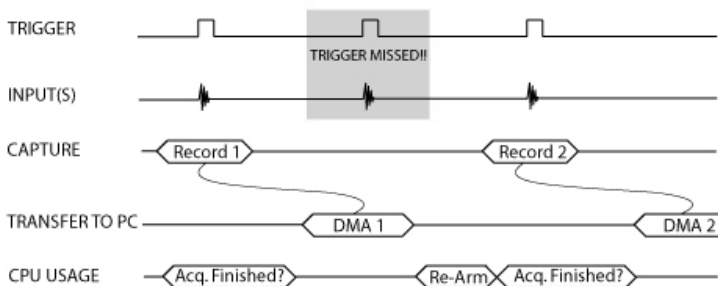

NOTE 1: Some Trigger events may be missed while data is being off-loaded from on-board memory

NOTE 2: Virtually all CPU cycles are used up in managing data acquisition. Very little left for for data processing

ATS9870 solves this problem by providing dual-port memory that can act as a very deep FIFO and an advanced dual-DMA engine that can stream data to PC host memory at up to 1.4 GB/s (exact rate is motherboard dependent).

### TRIGGERED DATA ACQUISITION USING DUAL-PORT MEMORY

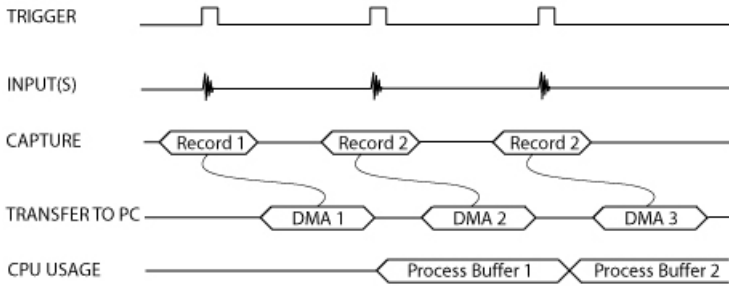

NOTE 1: No Trigger Events Are Missed - Guaranteed

NOTE 2: Over 95% of CPU cycles are available for data processing

Bottom line is that software does not have to wait until the end of data capture to read the acquired data.

## AutoDMA

Just having dual-ported memory or a FIFO, on its own, does not solve the problem of PRF captures or streaming applications. Software still has to get involved in re-arming the hardware after every capture and again for reading the data from on-board acquisition memory.

ATS9870's proprietary AutoDMA circuitry allows the acquisition system to be re-armed by a hardware command and data transfer to be initiated by the hardware itself, thus removing virtually all "in-process" software involvement.

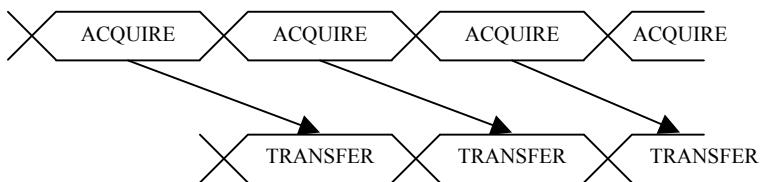

Of course, software still has to set up the DMA when one of the buffers fills up, but, thanks to the dual-DMA engine and fully asynchronous driver that uses overlapped IO, these tasks can be paralleled.

In other words, when software is re-arming DMA channel 0, DMA channel 1 is already transferring data to host memory.

Note that if data throughput is too high, a `DMA_OVERFLOW` flag gets set and is available to the programmer.

Consumption of the captured data is, of course, under the control of user-created software, and it is this that will determine the maximum PRF instead of the bus throughput.

The important thing to note is that if asynchronous DMA is used, CPU usage is no more than 5%, even if a 1.4 GB/s DMA is going on.

## **Traditional AutoDMA**

In order to acquire both pre-trigger and post-trigger data in a dual-ported memory environment, users can use Traditional AutoDMA.

Data is returned to the user in buffers, where each buffer can contain from 1 to 8192 records (triggers). This number is called RecordsPerBuffer.

Users can also specify that each record should come with its own header that contains a 40-bit trigger timestamp.

A BUFFER\_OVERFLOW flag is asserted if more than 512 buffers have been acquired by the acquisition system, but not transferred to host PC memory by the AutoDMA engine.

While Traditional AutoDMA can acquire data to PC host memory at the maximum sustained transfer rate of the motherboard, a BUFFER\_OVERFLOW can occur if more than 512 triggers occur in very rapid succession, even if all the on-board memory has not been used up.

## **No Pre-Trigger (NPT) AsyncDMA**

Many ultrasonic scanning and medical imaging applications do not need any pre-trigger data: only post-trigger data is sufficient.

NPT AutoDMA is designed specifically for these applications. By only storing post-trigger data, the memory bandwidth is optimized and the entire on-board memory acts like a very deep FIFO.

Note that a DMA is not started until RecordsPerBuffer number of records (triggers) have been acquired.

NPT AutoDMA buffers do not include headers, so it is not possible to get trigger time-stamps.

More importantly, a BUFFER\_OVERFLOW flag is asserted only if the entire on-board memory is used up. This provides a very substantial improvement over Traditional AutoDMA.

NPT AutoDMA can easily acquire data to PC host memory at the maximum sustained transfer rate of the motherboard without causing an overflow.

This is the recommended mode of operation for most ultrasonic scanning, OCT and medical imaging applications.

## **Continuous AsyncDMA**

Continuous AutoDMA is also known as the data streaming mode.

In this mode, data starts streaming across the PCI bus as soon as the ATS9870 is armed for acquisition. It is important to note that triggering is disabled in this mode.

Continuous AutoDMA buffers do not include headers, so it is not possible to get trigger time-stamps.

A `BUFFER_OVERFLOW` flag is asserted only if the entire on-board memory is used up.

The amount of data to be captured is controlled by counting the number of buffers acquired. Acquisition is stopped by an `AbortCapture` command.

Continuous AutoDMA can easily acquire data to PC host memory at the maximum sustained transfer rate of the motherboard without causing an overflow.

This is the recommended mode for very long signal recording.

## **Triggered Streaming AsyncDMA**

Triggered Streaming AutoDMA is virtually the same as Continuous mode, except the data transfer across the bus is held off until a trigger event has been detected.

Triggered Streaming AutoDMA buffers do not include headers, so it is not possible to get trigger time-stamps. A `BUFFER_OVERFLOW` flag is asserted only if the entire on-board memory is used up.

As in Continuous mode, the amount of data to be captured is controlled by counting the number of buffers acquired.

Acquisition is stopped by an `AbortCapture` command.

Triggered Streaming AutoDMA can easily acquire data to PC host memory at the maximum sustained transfer rate of the motherboard without causing an overflow.

This is the recommended mode for RF signal recording that has to be started at a specific time, e.g. based on a GPS pulse.

## **Stream To Disk**

Any one of the AutoDMA modes can be combined with a fast disk drive to create a very efficient and low cost data streaming system.

AlazarDSO Stream To Disk module (sold separately) allows out-of-the-box disk streaming. No programming is required. Note, however, that the speed with which data can be stored to memory will be limited by the lower of:

1. ATS9870 Bus Throughput (1.4 GB/s)
2. PCI Express throughput supported by the motherboard
3. Sustained Throughput of the disk drive system

AlazarDSO includes a Disk Throughput Benchmarking tool, using which you can quickly and easily see how fast your disk drives are.

Files are saved as ATB format binary files, and can automatically be converted to text files or MATLAB compatible files.

For more information on complete disk streaming systems, please contact the factory or your local distributor.



# Appendix A - Specifications

---

This appendix lists the specifications of the ATS9870. These specifications are typical at 25 °C unless otherwise stated. The operating temperature range is 0 to 50 °C.

## System Requirements

Personal computer with at least one free x8 or x16 PCI Express slot, 256 MB RAM, 20 MB of free hard disk space,

PCI Express revision	1.0a or higher
Transceiver speed	2.5 Gbps
Number of lanes	4 or 8
Compatibility - mechanical	x8 and x16 slots
Compatibility - electrical	x1, x4, x8 and x16 slots

## Power Requirements

+12V	1.5 A, typical
+3.3V	1.0 A, typical

## Physical

Size	Single slot, half-length PCI card (4.2 inches x 6.5 inches)
Weight	500 g

## I/O Connectors

ECLK	SMA female connector
CH A, CH B, TRIG IN, AUX I/O	BNC female connectors

## Environmental

Operating temperature	0 to 55 °C
Storage temperature	-20 to 70 °C
Relative humidity	5 to 95%, non-condensing

## Acquisition System

Resolution	8 bits
Bandwidth (-3dB)	
DC-coupled, 50 $\Omega$	$\pm 40\text{mV}$ range : DC - 200 MHz, All other input ranges: DC - 450 MHz
AC-coupled, 50 $\Omega$	$\pm 40\text{mV}$ range : 100 KHz - 200 MHz, All other input ranges: 100 KHz - 450 MHz
Number of channels	2 simultaneously sampled
Maximum Sample Rate	1 GS/s single shot (internal clock) 1 GS/s single shot (external clock)
Minimum Sample Rate	1 KS/s single shot (internal clock) 200 MS/s single shot (Fast External Clock)
Full Scale Input ranges	
50 $\Omega$ :	$\pm 40\text{mV}$ , $\pm 100\text{mV}$ , $\pm 200\text{mV}$ , $\pm 400\text{mV}$ , $\pm 1\text{V}$ , $\pm 2\text{V}$ and $\pm 4\text{V}$ , software selectable
DC accuracy	$\pm 2\%$ of full scale in all input ranges
Input coupling	AC or DC, software selectable
Input impedance	50 $\Omega$ fixed
Input protection	
50 $\Omega$	$\pm 5\text{V}$ (DC + peak AC for CH A, CH B and EXT only without external attenuation)

## Acquisition Memory System

Memory Size	256 MB, 2 GB or 4 GB
Record Length	Software selectable with 32-point resolution. Record length must be a minimum of 128 points and maximum of the on-board memory size for single-port memory operation.  There is no upper limit on the maximum record length in data streaming mode.
Number of Records	Software selectable from a minimum of 1 to a maximum of infinite number of records
Pre-trigger depth	From 0 to (Record Length - 128)
Post-trigger depth	Record Length - Pre-Trigger Depth

## Timebase System

Timebase options	Internal Clock or External Clock (Optional)
Internal Sample Rates	1 GS/s, 500 MS/s, 200 MS/s, 100 MS/s, 50 MS/s, 20 MS/s, 10 MS/s, 5 MS/s, 2 MS/s, 1 MS/s, 500 KS/s, 200 KS/s, 100KS/s, 50 KS/s, 20KS/s, 10KS/s, 5 KS/s, 2 KS/s, 1 KS/s
Internal Clock accuracy	±2 ppm

## Dynamic Parameters

Typical values measured using a randomly selected ATS9870. Input was provided by a HP8656A signal generator, followed by a 9-pole, 100 MHz band-pass filter (TTE Q36T-100M-10M-50-720B). Input frequency was set at 99.1 MHz and output amplitude was set at approximately 90% of the full scale in +/- 200 mV range.

SNR	44.28 dB
SINAD	42.78 dB
THD	-48.14 dB
SFDR	-48.98 dB

Note that these measurements were made using raw data: no signal averaging was used to artificially improve the results.

Further note that these dynamic parameters may vary from one unit to another, with input frequency and with the full-scale input range selected.

## Optional ECLK (External Clock) Input

Signal Level	Sine wave with amplitude between 100 mV <sub>p-p</sub> and 1 Volt <sub>p-p</sub>
Input impedance	50Ω
Input Coupling	AC
Maximum frequency	
Fast External Clock:	1 GHz with 50% ±5% duty cycle
Slow External Clock:	60 MHz with minimum positive or negative pulse width of 8 ns
10 MHz Clock Reference:	10.1 MHz
Minimum frequency	
Fast External Clock:	200 MHz with 50% ±5% duty cycle
Slow External Clock:	DC
10 MHz Clock Reference:	9.9 MHz
Decimation factor	Software selectable from 1 to 100,000 Fixed to 1 for Slow External Clock
Sampling Edge	Rising or Falling, software selectable
Sample Rates Available With 10 MHz Clock Reference:	1 GS/s

Other sample rates may be obtained by decimating the 1 GHz clock generated by the on-board PLL

Note that the accuracy and stability of these sampling frequencies is dependent on the accuracy and stability of the 10 MHz Clock Reference input supplied by the user

## Triggering System

Mode	Edge triggering with fixed hysteresis
Number of Trigger Engines	2
Trigger Engine Combination	OR, AND, XOR, software selectable
Trigger Engine Source	CH A, CH B, EXT, Software or None, independently software selectable for each of the two Trigger Engines
Hysteresis	±5% of full-scale input, typical
Trigger sensitivity	±10% of full scale input range. This implies that the trigger system may not trigger reliably if the input has an amplitude less than ±10% of full-scale input range selected
Trigger level accuracy	±10%, typical, of full-scale input range of the selected trigger source
Bandwidth	450 MHz
Trigger Delay	Software selectable from 0 to 9,999,999 sampling clock cycles
Trigger Timeout	Software selectable with a 10 us resolution. Maximum settable value is 3,600 seconds. Can also be disabled to wait indefinitely for a trigger event

## EXT (External Trigger) Input

Input impedance	10 K $\Omega$ in parallel with 30pF ±10pF
Bandwidth (-3dB)	
DC-coupled	DC - 250 MHz
AC-coupled	100 KHz - 250 MHz
Input range	±5V
DC accuracy	±10% of full-scale input
Input protection	±5V (DC + peak AC without external attenuation)
Coupling	AC or DC, software selectable

## Auxiliary I/O (AUX I/O)

Signal Direction	Input or Output, software selectable Output by default
Output Types:	Trigger Output

Busy Output  
Software controlled Digital Output

Input Types: Trigger Enable  
Software readable Digital Input

Output

Amplitude: 5 Volt TTL  
Synchronization: Synchronized to internal divide-by-16 clock

Input

Amplitude: 5 Volt TTL or 3.3 Volt TTL

## **Certification and Compliances**

CE Mark Compliance

## **Materials Supplied**

One ATS9870 Digitizer  
One ATS9870 Install Disk  
One ATS9870 User Manual

***All specifications are subject to change without notice***

# Appendix B - Benchmarks

---

This appendix lists the data throughput measured by our technicians on various computers and motherboards under different operating systems.

- Given the constantly changing nature of computers, these benchmarks are provided as a reference only and AlazarTech assumes no liability in case the computer you purchase behaves differently than what was observed in AlazarTech's laboratory.

Model	Chipset	Slot	O/S	Throughput
Intel S5000PSL	Intel 5000P	PCIe x8	Win XP 32-bit	1.4 GB/s
Intel S5000PSL	Intel 5000P	PCIe x8	Win XP 64-bit	1.4 GB/s
Intel S5000PSL	Intel 5000P	PCIe x8	Vista 32-bit	1.4 GB/s
Intel S5000PSL	Intel 5000P	PCIe x8	Vista 64-bit	1.4 GB/s
Tyan S2915-E	nVIDIA NPF3600 + NPF 3050	PCIe x8	Win XP 64-bit	1.4 GB/s
Dell T3400	Intel 975 Express	PCI e x4	Win XP 32-bit	800 MB/s
Dell T7400	Intel 5400	PCIe x8	Win XP 64-bit	1.1 GB/s
Dell T7400	Intel 5400	PCIe x8	Vista 64-bit	1.1 GB/s
SuperMicro X7DB3	Intel 5000P	PCIe x8	Win XP 32-bit	1.1 GB/s
Intel DG965RY	Intel 965	PCIe x16	Win XP 32-bit	840 MB/s





**ALAZAR TECHNOLOGIES INC.**

6600 Trans-Canada Highway  
Suite 310  
Pointe-Claire, QC  
CANADA H9R 4S2

Tel: (514) 426-4899

Fax: (514) 426-2723

E-mail: [info@alazartech.com](mailto:info@alazartech.com)

Web: [www.alazartech.com](http://www.alazartech.com)