

ATS-SDK User Guide

Version 24.2.0

April 9, 2024



CONTENTS

1	License Agreement	3
1.1	Important	3
1.2	Ownership	3
1.3	Rights	4
1.4	Limited Warranty	4
2	Getting Started	7
2.1	Introduction	7
2.2	Programming Environments	9
2.3	Sample code	13
2.4	Contacting us	14
3	Programmer's Guide	15
3.1	Addressing a board	15
3.2	Resetting a board	18
3.3	Configuring a board	18
3.4	Acquiring data	34
3.5	Processing data	58
4	AlazarDSP API Documentation	71
4.1	Introduction	71
4.2	Detailed Description	73
5	Advanced Topics	75
5.1	External clock issues for OCT applications	75
5.2	Multi-Threading Considerations	78
6	API Reference	79
6.1	AlazarAbortAsyncRead	81
6.2	AlazarAbortCapture	81
6.3	AlazarAllocBufferU16	82
6.4	AlazarAllocBufferU16Ex	82
6.5	AlazarAllocBufferU8	83
6.6	AlazarAllocBufferU8Ex	83
6.7	AlazarAsyncRead	84
6.8	AlazarBeforeAsyncRead	85

6.9	AlazarBoardsFound	93
6.10	AlazarBoardsInSystemByHandle	93
6.11	AlazarBoardsInSystemBySystemID	94
6.12	AlazarBusy	94
6.13	AlazarConfigureAuxIO	95
6.14	AlazarConfigureLSB	97
6.15	AlazarConfigureRecordAverage	98
6.16	AlazarConfigureSampleSkipping	100
6.17	AlazarCoprocesorDownload	102
6.18	AlazarCoprocesorRegisterRead	104
6.19	AlazarCoprocesorRegisterWrite	104
6.20	AlazarCreateStreamFile	105
6.21	AlazarDSPAbortCapture	107
6.22	AlazarDSPGenerateWindowFunction	107
6.23	AlazarDSPGetBuffer	109
6.24	AlazarDSPGetInfo	110
6.25	AlazarDSPGetModules	111
6.26	AlazarDSPGetNextBuffer	112
6.27	AlazarDSPGetParameterFloat	113
6.28	AlazarDSPGetParameterS32	114
6.29	AlazarDSPGetParameterU32	115
6.30	AlazarDSPSetParameterFloat	116
6.31	AlazarDSPSetParameterS32	116
6.32	AlazarDSPSetParameterU32	117
6.33	AlazarErrorToText	117
6.34	AlazarExtractFFTNPTFooters	125
6.35	AlazarExtractNPTFooters	126
6.36	AlazarExtractTimeDomainNPTFooters	128
6.37	AlazarFFTBackgroundSubtractionGetRecords16	129
6.38	AlazarFFTBackgroundSubtractionSetEnabled	129
6.39	AlazarFFTBackgroundSubtractionSetRecords16	130
6.40	AlazarFFTGetMaxTriggerRepeatRate	130
6.41	AlazarFFTSetGainAndOffset	131
6.42	AlazarFFTSetScalingAndSlicing	132
6.43	AlazarFFTSetWindowFunction	134
6.44	AlazarFFTSetup	135
6.45	AlazarForceTrigger	137
6.46	AlazarForceTriggerEnable	138
6.47	AlazarFreeBufferU16	138
6.48	AlazarFreeBufferU16Ex	139
6.49	AlazarFreeBufferU8	139
6.50	AlazarFreeBufferU8Ex	139
6.51	AlazarGetBoardBySystemHandle	140
6.52	AlazarGetBoardBySystemID	140
6.53	AlazarGetBoardKind	141
6.54	AlazarGetBoardRevision	146
6.55	AlazarGetCPLDVersion	146
6.56	AlazarGetChannelInfo	147

6.57	AlazarGetChannelInfoEx	148
6.58	AlazarGetDriverVersion	148
6.59	AlazarGetFPGAVersion	149
6.60	AlazarGetMaxRecordsCapable	150
6.61	AlazarGetParameter	151
6.62	AlazarGetParameterLL	155
6.63	AlazarGetParameterUL	155
6.64	AlazarGetSDKVersion	157
6.65	AlazarGetStatus	158
6.66	AlazarGetSystemHandle	159
6.67	AlazarGetTriggerAddress	159
6.68	AlazarGetTriggerTimestamp	161
6.69	AlazarGetWhoTriggeredBySystemHandle	161
6.70	AlazarGetWhoTriggeredBySystemID	162
6.71	AlazarHyperDisp	163
6.72	AlazarInputControl	164
6.73	AlazarInputControlEx	172
6.74	AlazarNumOfSystems	173
6.75	AlazarOCTIgnoreBadClock	173
6.76	AlazarPostAsyncBuffer	175
6.77	AlazarQueryCapability	176
6.78	AlazarQueryCapabilityLL	181
6.79	AlazarRead	181
6.80	AlazarReadEx	183
6.81	AlazarResetTimeStamap	184
6.82	AlazarSetADCBackgroundCompensation	185
6.83	AlazarSetBWLlimit	185
6.84	AlazarSetCaptureClock	186
6.85	AlazarSetExternalClockLevel	192
6.86	AlazarSetExternalTrigger	193
6.87	AlazarSetLED	194
6.88	AlazarSetParameter	195
6.89	AlazarSetParameterLL	195
6.90	AlazarSetParameterUL	196
6.91	AlazarSetRecordCount	196
6.92	AlazarSetRecordSize	197
6.93	AlazarSetTriggerDelay	198
6.94	AlazarSetTriggerOperation	199
6.95	AlazarSetTriggerOperationForScanning	203
6.96	AlazarSetTriggerTimeOut	204
6.97	AlazarSleepDevice	205
6.98	AlazarStartCapture	206
6.99	AlazarTriggered	206
6.100	AlazarWaitAsyncBufferComplete	207
6.101	AlazarWaitNextAsyncBufferComplete	208
7	Board-Specific Information	211
7.1	Supported impedances and input ranges	211

7.2	Samples per record requirements	212
7.3	Samples per timestamp and trigger delay alignment	213
7.4	Aux I/O output Synchronization	214
7.5	Possible input channel configurations	215
7.6	Supported sample rates	215
7.7	Miscellaneous features support	217
7.8	External trigger level support	217
7.9	Supported clock types	218
7.10	Frequency limits for external clock types	219
7.11	Valid frequencies in PLL mode	220

Index **221**

Note: This is the documentation for AlazarTech's ATS-SDK version 24.2.0. Please visit our [documentation homepage](#) to find documentation for other versions or products.

LICENSE AGREEMENT

Copyright (c) 2008-2024 Alazar Technologies Inc. All rights reserved.

1.1 Important

CAREFULLY READ THIS SOFTWARE LICENSE AGREEMENT. BY CLICKING THE APPLICABLE BUTTON TO COMPLETE THE INSTALLATION PROCESS, YOU AGREE TO BE BOUND BY THE TERMS OF THIS AGREEMENT. IF YOU DO NOT WISH TO BECOME A PARTY TO THIS AGREEMENT AND BE BOUND BY ITS TERMS AND CONDITIONS, DO NOT INSTALL OR USE THE SOFTWARE, AND RETURN THE SOFTWARE (WITH ANY ACCOMPANYING MEDIA) WITHIN THIRTY (30) DAYS OF RECEIPT. ALL RETURNS TO ALAZAR TECHNOLOGIES INC. (“ALAZARTECH”) WILL BE SUBJECT TO ALAZARTECH’S THEN-CURRENT POLICY. IF YOU ARE ACCEPTING THESE TERMS ON BEHALF OF AN ENTITY, YOU AGREE THAT YOU HAVE AUTHORITY TO BIND THE ENTITY TO THESE TERMS.

1.2 Ownership

AlazarTech retains the ownership of ATS-SDK software (“Software”). It is licensed to you for use under the following conditions:

1.2.1 Grant of License

You may only concurrently use the Software on the computers that have an AlazarTech waveform digitizer card plugged in (for example, if you have purchased one AlazarTech card, you have a license for one concurrent usage). If the number of users of the Software exceeds the number of AlazarTech cards you have purchased, you must have a reasonable process in place to assure that the number of persons concurrently using the Software does not exceed the number of AlazarTech cards purchased.

This license is non-transferable.

1.2.2 Restrictions

You may not copy the documentation or Software except as described in the installation section of the Software manual. You may not distribute, rent, sub-lease or lease the Software or documentation, including translating or decomposing. You may not modify, reverse-engineer, decompile, or disassemble any part of the Software or documentation, or produce any derivative work other than software applications that communicate with AlazarTech hardware using the published Application Programming Interface (API).

You may not remove, block, or modify any titles, logos, trademarks, copyright and/or patent notices, digital watermarks, disclaimers, or other legal notices that are included in the Software.

1.2.3 Termination

This license and your right to use this Software automatically terminates if you fail to comply with any provision of this license agreement.

1.3 Rights

AlazarTech retains all rights not expressly granted. Nothing in this agreement constitutes a waiver of AlazarTech's rights under the Canadian and U.S. copyright laws or any other Federal or State law.

1.4 Limited Warranty

Although AlazarTech has tested the Software and reviewed the documentation, ALAZARTECH MAKES NO WARRANTY OF REPRESENTATION, EITHER EXPRESSED OR IMPLIED, WITH RESPECT TO THIS SOFTWARE OR DOCUMENTATION, ITS QUALITY, PERFORMANCE, MERCHANTABILITY, OR FITNESS FOR A PARTICULAR PURPOSE. AS A RESULT, THIS SOFTWARE AND DOCUMENTATION IS LICENSED "as is" AND YOU, THE LICENSEE, ARE ASSUMING THE ENTIRE RISK AS TO ITS QUALITY AND PERFORMANCE. IN NO EVENT WILL ALAZARTECH BE LIABLE FOR DIRECT, INDIRECT, SPECIAL, INCIDENTAL OR CONSEQUENTIAL DAMAGES ARISING OUT OF THE USE OR INABILITY TO USE THIS SOFTWARE OR DOCUMENTATION, even if advised of the possibility of such damages. In particular, AlazarTech shall have no liability for any data acquired, stored or processed with this Software, including the costs of recovering such data.

THE WARRANTY AND REMEDIES SET FORTH ABOVE ARE EXCLUSIVE AND IN LIEU OF ALL OTHERS, ORAL OR WRITTEN, EXPRESSED OR IMPLIED. No AlazarTech dealer, agent or employee is authorized to make any modifications or additions to this warranty.

Information in this document is subject to change without notice and does not represent a commitment on the part of AlazarTech. The Software described in this document is fur-

nished under this license agreement. The Software may be used or copied only in accordance with the terms of the agreement.

Some jurisdictions do not allow the exclusion of implied warranties or liability for incidental or consequential damages, so the above limitation or exclusion may not apply to you. This warranty gives you specific legal rights, and you may also have other rights, which vary from jurisdiction to jurisdiction.

GETTING STARTED

2.1 Introduction

AlazarTech supplies device drivers for Windows and Linux that allow software to configure AlazarTech digitizers, and transfer sample data from the digitizer to application buffers.

The AlazarTech software developer's kit (ATS-SDK) includes header and library files required to call functions exported by these device drivers in user written applications, as well as documentation and sample code describing how to use these functions.

This document is a part of the ATS-SDK. It describes how to call functions exported by AlazarTech device drivers to control one or more digitizer boards. It is divided into the following sections:

- A programming guide that describes how to configure, and acquire data from, digitizer boards.
- A reference guide that describes the functions exported by the device drivers.

To get the most from your AlazarTech digitizer:

- Read the user manual supplied their digitizer board. It provides an overview of the digitizer hardware, as well as detailed specifications.
- Read the "Programmer's guide" section of this document. It describes how to program the digitizer hardware to make an acquisition, and to transfer sample data into application buffers.
- Browse the SDK sample programs. They include sample code that demonstrates how to make many types of acquisitions supported by the digitizer.

Note that this document includes descriptions of board specific features and options that may not be available on your digitizer board. Please refer your board's user manual for its specifications.

Document navigation

This manual contains intra-document links. You will need a PDF viewer with “Previous View” functionality to navigate through the manual with ease.

If you are opening this PDF manual with the built-in Mozilla® Firefox® PDF viewer, you can right-click anywhere in the PDF window to access page navigation:

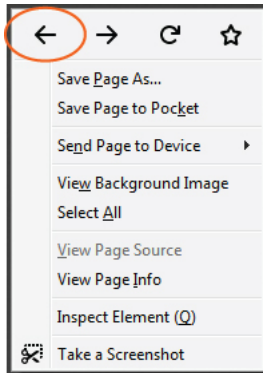

Otherwise, this PDF manual is best viewed using a PDF viewer with “Previous View” functionality. If your preferred PDF viewer does not include this functionality, you may wish to use one of the following¹ options:

- Foxit® Reader: <https://www.foxitsoftware.com/pdf-reader/> (available for Linux and Windows)
- PDF Studio 2018: <https://www.qoppa.com/pdfstudioviewer/download/> (available for Linux and Windows)
- Adobe® Acrobat® Reader DC: <https://get.adobe.com/reader/> (available for Windows)

If you are using Adobe Acrobat Reader, you will need to enable the Previous View and Next View Page Navigation tools: Right-click on the top toolbar and go to Show Page Navigation Tools, then select Previous View. Repeat the process for Next View.

¹ This manual includes links to information created and maintained by other private and/or public organizations. Alazar Technologies Inc. (AlazarTech) provides these links solely for our users’ information and convenience. AlazarTech does not control or guarantee the accuracy, relevance, or completeness of information contained on a linked website. Furthermore, AlazarTech does not endorse these organizations or the views they express or the products/services they offer. AlazarTech is not responsible for transmissions users receive from linked websites, nor is it responsible for or liable in any way for commercial transactions which users transact with linked websites.

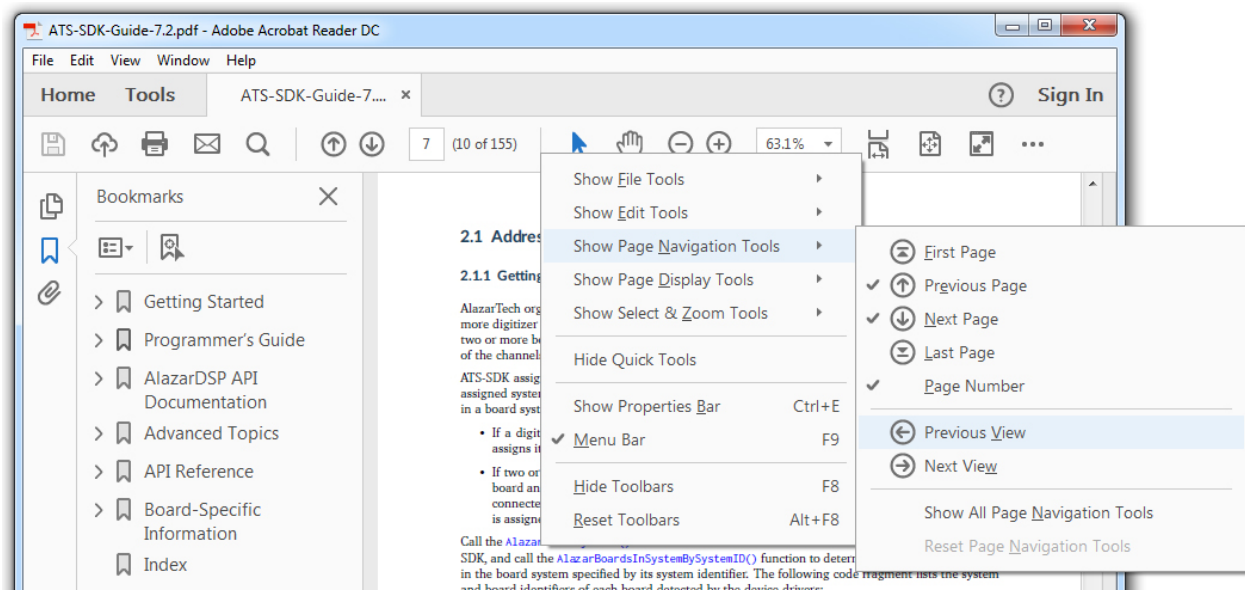

2.2 Programming Environments

2.2.1 C/C++ Linux

C/C++ developers under Linux should include the following header files in source files that use functions exported by the ATS-SDK library:

```
#include "AlazarError.h"
#include "AlazarApi.h"
#include "AlazarCmd.h"
```

These modules should also link against libATSapi.so.

The development package for Linux defaults to installing the header files in /usr/local/AlazarTech/include, and the library files in the standard library directory for the target distribution.

2.2.2 C/C++ Windows

C/C++ developers should include the following header files in source files that use functions exported by the API library:

```
#include "AlazarError.h"
#include "AlazarApi.h"
#include "AlazarCmd.h"
```

These applications should also link against the 32- or 64-bit version of ATSapi.lib, as required.

The SDK setup program installs the header files in “Samples_C\Include”, and the library files in “Samples_C\Library”.

2.2.3 C#

C# developers should either:

- Add the file AlazarApi.cs to their project; or
- Add a reference to AlazarApiNet.dll to their project.

The ATS-SDK includes a wrapper class that declares many of the constants and unmanaged functions exported by AlazarTech device drivers. This class is provided both as a C# source file (AlazarApi.cs), and as a compiled assembly (AlazarApiNet.dll).

The SDK setup program copies AlazarApi.cs to the “Samples_CSharp\AlazarApiNet\AlazarApiNet” directory and AlazarApiNet.dll to the “Samples_CSharp” directory.

Note that you can use the solution “Samples_CSharp\AlazarApiNet” to build AlazarApiNet.dll from AlazarApi.cs.

2.2.4 LabVIEW

LabVIEW developers can either:

- Use the sub-VIs provided with the ATS-SDK (recommended)
- Call functions from ATSApi.dll directly using the LabVIEW interface for shared libraries.

The ATS-SDK sub-VIs consists of a very thin wrapper on top of the functions exported by the ATS-SDK. The VIs are named after the functions that they wrap. They are located in “Samples_LabVIEW\Library”, and are used by all the code samples available in “Samples_LabVIEW”.

The only difference between the connector panes of the VIs and the C function signatures is that an error cluster is propagated through the VIs. If the input error cluster contains an error, the VI simply returns without doing anything.

The error cluster output depends on the function:

- If the function does not generate errors, the input error cluster is simply propagated to the output.
- If the function returns an error code, it is converted to a cluster and send to the output
- If the function can return errors using special return values, then these errors are detected by the VI, an appropriate error code is generated, converted to a cluster and sent to the output

2.2.5 Python

Python developers can use the `atsapi.py` module provided in the “Samples_Python\Library” directory. It provides a very thin wrapper around the AlazarTech C/C++ API, with only minor differences:

- The ‘Alazar’ prefixes have been removed from the function names, and the first letter is not capitalized. For example, ‘AlazarAbortAsyncRead’ becomes ‘abortAsyncRead’.
- Board handles have been removed. Instead, a Board class has been added. All the functions that take a board handle as a parameter are moved to being member functions of the Board class.
- A DMABuffer convenience class has been added, that takes care of memory allocation of DMA transfers.
- Some functions of the API use return parameters to give back to the caller primitive types. In Python, the signature of these functions is changed so that the return parameters are replaced with return types.

2.2.6 MATLAB

MATLAB developers should use the functions provided in “Samples_MATLAB/Include” to call functions from the ATSApi DLL. There is a one to one mapping between MATLAB and C ATSApi functions, but the arguments and return values differ in the following ways:

1. MATLAB functions do not return error codes, instead, they throw exceptions if the return code of the associated C function is not `ApiSuccess`. For example, a C program that wants to call the `AlazarStartCapture()` function should be written like so:

```
RETURN_CODE rc = AlazarStartCapture(boardHandle);
if (rc != ApiSuccess) {
    // TODO: handle error (e.g. return a failure code).
}
```

By opposition, a MATLAB program that wishes to call the same function should simply use the following at the call site:

```
AlazarStartCapture(boardHandle);
```

Note that because this function will throw in case of an error, it is necessary for the MATLAB program to include exception handling code higher in the call stack if terminating upon error is not acceptable.

2. Output parameters in C functions are return values in their MATLAB equivalents. Here is how `AlazarGetChannelInfo()` can be called from a C program:

```
U32 memorySize = 0;
U32 bitsPerSample = 0;
RETURN_CODE rc = AlazarGetChannelInfo(boardHandle,
                                     &memorySize,
```

(continues on next page)

(continued from previous page)

```
                                &bitsPerSample);  
if (rc != ApiSuccess) {  
    // TODO: handle error (e.g. return a failure code).  
}
```

By contrast, here is the same function call in a MATLAB program:

```
[memorySizeInSamples, bitsPerSample] = AlazarGetChannelInfo(boardHandle)
```

3. In C programs, arrays are always allocated by the user code, and are passed as a pair of arguments (a pointer and a size). In MATLAB, arrays are passed to or returned from functions by value instead.

This change significantly simplifies some function calls. For example, here is how to generate a window function in a C program:

```
U32 windowType = ...;  
U32 windowLength = ...;  
U32 paddingLength = ...;  
float* window = (float*) malloc(windowLength + paddingLength, sizeof(float));  
if (!window) {  
    // TODO: handle error  
}  
RETURN_CODE rc AlazarDSPGenerateWindowFunction(windowType,  
                                                window,  
                                                windowLength,  
                                                paddingLength);  
if (rc != ApiSuccess) {  
    // TODO: handle error (e.g. return a failure code).  
}
```

Here is how to generate this function from MATLAB:

```
windowType = ...;  
windowLength = ...;  
paddingLength = ...;  
window = AlazarDSPGenerateWindowFunction(windowType,  
                                         windowLength,  
                                         paddingLength);
```

Note: This change does not apply to DMA buffers. For performance reasons (to avoid costly copies), buffers are passed by reference in MATLAB functions.

2.2.7 C++/CLI

C++/CLI programmers should include a reference to “Samples_CSharp\AlazarApiNet.dll” in their solutions. This assembly provides a .NET interface to the functions and constants defined in the ATS-SDK.

The ATS-SDK does not currently include C++/CLI sample code. See the C# samples for .NET sample code.

2.3 Sample code

ATS-SDK includes sample programs that demonstrate how to configure and acquire data from AlazarTech digitizers.

The SDK setup program installs the sample programs to “C:\AlazarTech\ATS-SDK\%API_VERSION%” under Microsoft Windows, and “/usr/local/AlazarTech” under Linux. See the “ReadMe.htm” file in the ATS-SDK base directory for a description of the samples included.

Sample programs are available for the following programming environments in the following sub-directories:

Language	Sub-directory
C/C++	Samples_C
C#	Samples_CSharp
MATLAB	Samples_MATLAB
LabVIEW	Samples_LabVIEW
Python	Samples_Python

Note: Note that the sample programs contain many parameters that should be modified. These lines of code are preceded by “TODO” comments. Please search for these lines and modify them as required for your application.

Warning: Many sample programs require a trigger input. These sample programs configure a board to trigger when a signal connected to its CH A rises through 0V. Before running these samples, connect a 1 kHz sine waveform of amplitude about 90% of the board’s input range from a function generator to the CH A connector, or modify trigger parameters as required. For example, the ATS9360 has an input range of +/- 400 mV. For this board, a sine wave of 700 mVpp is appropriate. If an appropriate trigger signal is not supplied, these samples will fail with an acquisition timeout error.

2.4 Contacting us

Contact us if you have any questions or comments about this document, or the sample code.

Web	https://www.alazartech.com/
Email	support@alazartech.com
Phone	+1-514-426-4899
Fax	+1-514-426-2723
Mail	
	Alazar Technologies Inc. 6600 Trans-Canada Highway, Suite 310 Pointe-Claire, QC Canada H9R 4S2

Note that you can download the latest drivers and documentation from our web site.

<https://www.alazartech.com/Support/Downloads>

3.1 Addressing a board

3.1.1 Getting a board identifier

AlazarTech organizes its digitizer boards into “board systems”. A board system is a group of one or more digitizer boards that share trigger and clock signals. To create a “board system” comprised of two or more boards, the boards need to be connected together using an AlazarTech SyncBoard. All of the channels in a board system trigger and are sampled simultaneously.

ATS-SDK assigns a “system identifier” number to each board system. The first system detected is assigned system ID number of 1. In addition, a “board identifier” number is assigned to each board in a board system. This number uniquely identifies a board within its board system.

- If a digitizer board is not connected to any other boards using a SyncBoard, then the SDK assigns it a board ID of 1.
- If two or more boards are connected together using a SyncBoard, then the SDK assigns each board an ID number that depends on how the board is connected to the SyncBoard. The board connected to the “master” slot on the SyncBoard is the master board in the board system and is assigned a board ID number of 1.

Call the [AlazarNumOfSystems\(\)](#) function to determine the number of board systems detected by the SDK, and call the [AlazarBoardsInSystemBySystemID\(\)](#) function to determine the number of boards in the board system specified by its system identifier. The following code fragment lists the system and board identifiers of each board detected by the device drivers:

```
U32 systemCount = AlazarNumOfSystems();
for (U32 systemId = 1; systemId <= systemCount; systemId++) {
    U32 boardCount = AlazarBoardsInSystemBySystemID(systemId);
    for (U32 boardId = 1; boardId <= boardCount; boardId++) {
        printf("Found SystemID %u Board ID = %u\\n", systemId, boardId);
    }
}
```

3.1.2 Getting a board handle

ATS-SDK associates a handle with each digitizer board. Most functions require a board handle as a parameter. For example, the `AlazarSetLED()` function allows an application to control the LED on the PCI/PCIe mounting bracket of a board specified by its handle.

Use the `AlazarGetBoardBySystemID()` API function to get a handle to a board specified by its system identifier and board identifier numbers.

Single board installations

If only one board is installed in a computer, ATS-SDK assigns it system ID 1 and board ID 1. The following code fragment gets a handle to such a board, and uses this handle to toggle the LED on the board's PCI/PCIe mounting bracket:

```
// Select a board
U32 systemId = 1;
U32 boardId = 1;

// Get a handle to the board
HANDLE boardHandle = AlazarGetBoardBySystemID(systemId, boardId);

// Toggle the LED on the board's PCI/PCIe mounting bracket
AlazarSetLED(boardHandle, LED_ON);
Sleep(500);
AlazarSetLED(boardHandle, LED_OFF);
```

Multiple board installations

If more than one board is installed in a PC, the boards are organized into board systems, and are assigned system and board identifier numbers. The following code fragment demonstrates how to obtain a handle to each board in such an installation, and use the handle to toggle the LED on the board's PCI/PCIe mounting bracket:

```
U32 systemCount = AlazarNumOfSystems();
for (U32 systemId = 1; systemId <= systemCount; systemId++) {
    U32 boardCount = AlazarBoardsInSystemBySystemID(systemId);
    for (U32 boardId = 1; boardId <= boardCount; boardId++) {
        printf("SystemID %u Board ID = %u\\n", systemId, boardId);

        // Get a handle to the board
        HANDLE handle = AlazarGetBoardBySystemID(systemId, boardId);

        // Toggle the LED on the board's PCI/PCIe mounting bracket
        AlazarSetLED(handle, LED_ON);
        Sleep(500);
        AlazarSetLED(handle, LED_OFF);
    }
}
```

System handles

Several ATS-SDK functions require a “system handle”. A system handle is the handle of the master board in a board system.

- If a board is not connected to other boards using a SyncBoard, then its board handle is the system handle.
- If a board is connected to other boards using a SyncBoard, then the board that is connected to the master connector on the SyncBoard is the master board, and its board handle is the system handle.

3.1.3 Closing a board handle

ATS-SDK maintains a list of board handles in order to support master-slave board systems. The SDK creates board handles when it is loaded into memory, and destroys these handles when it is unloaded from memory. An application should not need to close a board handle.

3.1.4 Using a board handle

ATS-SDK includes a number of functions that return information about a board specified by its handle. These functions include:

`AlazarGetBoardKind()`

Get a board’s model from its handle.

`AlazarGetChannelInfo()`

Get the number of bits per sample, and on-board memory size in samples per channel.

`AlazarGetCPLDVersion()`

Get the CPLD version of a board.

`AlazarGetDriverVersion()`

Get the driver version of a board.

`AlazarGetParameter()`

Get a board parameter as a signed 32-bit value.

`AlazarGetParameterUL()`

Get a board parameter as an unsigned 32-bit value.

`AlazarQueryCapability()`

Get a board capability as an unsigned 32-bit value.

The sample program “%ATS_SDK_DIR%\Samples\AlazarSysInfo” demonstrates how get a board handle and use it to obtain board properties. The API also exports functions that use a board handle to configure a board, arm it to make an acquisition, and transfer sample data from the board to application buffers. These topics are discussed in the following sections.

3.2 Resetting a board

The ATS-SDK resets all digitizer boards during its initialization procedure. This initialization procedure automatically runs when the API library is loaded into memory.

- If an application statically links against the API library, the API resets all boards when the application is launched.
- If an application dynamically loads the API library, the API resets all boards when the application loads the API into memory.

Warning: Note that when an application using the API is launched, all digitizer boards are reset. If one application using the API is running when a second application using the API is launched, configuration settings written by the first application to a board may be lost. If a data transfer between the first application and a board was in progress, data corruption may occur.

3.3 Configuring a board

Before acquiring data from a board system, an application must configure the timebase, analog inputs, and trigger system settings of each board in the board system.

3.3.1 Timebase

The timebase of the ADC converters on AlazarTech digitizer boards may be supplied by:

- Its on-board oscillators.
- A user supplied external clock signal.
- An on-board PLL clocked by a user supplied 10 MHz reference signal.

Internal clock

To use on-board oscillators as a timebase, call `AlazarSetCaptureClock()` specifying `INTERNAL_CLOCK` as the clock source identifier, and select the desired sample rate with a sample rate identifier appropriate for the board. The following code fragment shows how to select a 10 MS/s internal sample rate:

```
AlazarSetCaptureClock(handle, // HANDLE -- board handle
    INTERNAL_CLOCK, // U32 -- clock source Id
    SAMPLE_RATE_10MSPS, // U32 -- sample rate Id or value
    CLOCK_EDGE_RISING, // U32 -- clock edge Id
    0 // U32 -- decimation
);
```

See [AlazarSetCaptureClock\(\)](#) or the board reference manual for a list of sample rate identifiers appropriate for a board.

External clock

AlazarTech boards optionally support using a user-supplied external clock signal input to the ECLK connector on its PCI/PCIe mounting bracket to clock its ADC converters.

To use an external clock signal as a timebase, call [AlazarSetCaptureClock\(\)](#) specifying `SAMPLE_RATE_USER_DEF` as the sample rate identifier, and select a clock source identifier appropriate for the board model and the external clock properties. The following code fragment shows how to configure an ATS460 to acquire at 100 MS/s with a 100 MHz external clock:

```
AlazarSetCaptureClock(handle, // HANDLE -- board handle
                     FAST_EXTERNAL_CLOCK, // U32 -- clock source Id
                     SAMPLE_RATE_USER_DEF, // U32 -- sample rate Id or value
                     CLOCK_EDGE_RISING, // U32 -- clock edge Id
                     0 // U32 -- decimation
                     );
```

See the board reference manual for the properties of an external clock signal that are appropriate for a board, and [AlazarSetCaptureClock\(\)](#) for a list of external clock source identifiers.

External clock level

Some boards allow adjusting the comparator level of the external clock input receiver to match the receiver to the clock signal supplied to the ECLK connector. If necessary, call [AlazarSetExternalClockLevel\(\)](#) to set the relative external clock input receiver comparator level, in percent.

AlazarSetExternalClockLevel()

```
handle, // HANDLE -- board handle level_percent, // float -- external clock
level in percent );
```

10 MHz PLL

Some boards can generate a timebase from an on-board PLL clocked by user supplied external 10 MHz reference signal input to its ECLK connector.

ATS660

In 10 MHz PLL external clock mode, the ATS660 can generate a sample clock between 110 and 130 MHz, in 1 MHz, steps from an external 10 MHz reference input. Call `AlazarSetCaptureClock()` specifying `EXTERNAL_CLOCK_10MHZ_REF` as the clock source identifier, the desired sample rate between 110 and 130 MHz in 1 MHz steps, and a decimation factor of 1 to 100000. Note that the decimation value should be one less than the desired decimation factor. The following code fragment shows how to generate a 32.5 MS/s sample rate (130 MHz / 3) from a 10 MHz PLL external clock input:

```
AlazarSetCaptureClock(  
    handle, // HANDLE - board handle  
    EXTERNAL_CLOCK_10MHZ_REF, // U32 - clock source Id  
    130000000, // U32 - sample rate Id or value  
    CLOCK_EDGE_RISING, // U32 - clock edge Id  
    2 // U32 - decimation value  
);
```

ATS9325

In 10 MHz PLL external clock mode, the ATS9325 generates a 500 MHz sample clock from an external 10 MHz reference input. The 500 MS/s sample data can be decimated by a factor of 2, 4, or any multiple of 5.

Call `AlazarSetCaptureClock()` specifying `EXTERNAL_CLOCK_10MHZ_REF` as the clock source and 500 MHz as the sample rate, and select a decimation factor of 2, 4, or any multiple of 5, up to 100000. For example, the following code fragment shows how to generate a 100 MS/s sample rate (500 MHz / 5) from a 10 MHz external clock input:

```
AlazarSetCaptureClock(  
    handle, // HANDLE -- board handle  
    EXTERNAL_CLOCK_10MHZ_REF, // U32 -- clock source Id  
    500000000, // U32 -- sample rate Id  
    CLOCK_EDGE_RISING, // U32 -- clock edge Id  
    5 // U32 -- decimation  
);
```

ATS9350/ATS9351/ATS9352/ATS9353

In 10 MHz PLL external clock mode, the ATS9350, ATS9351, ATS9352 and ATS9553 generate a 500 MHz sample clock from an external 10 MHz reference input. The 500 MS/s sample data can be decimated by a factor of 1, 2, 4, or any multiple of 5. Call `AlazarSetCaptureClock()` specifying `EXTERNAL_CLOCK_10MHZ_REF` as the clock source and 500 MHz as the sample rate, and select a decimation factor of 1, 2, 4, or any multiple of 5 up to 100000. For example, the following code fragment shows how to generate a 100 MS/s sample rate (500 MHz / 5) from a 10 MHz external clock input:

```
AlazarSetCaptureClock(
    handle, // HANDLE - board handle
    EXTERNAL_CLOCK_10MHZ_REF, // U32 - clock source Id
    500000000, // U32 - sample rate Id
    CLOCK_EDGE_RISING, // U32 - clock edge Id
    5 // U32 - decimation
);
```

ATS9360

In 10 MHz PLL external clock mode, the ATS9360 can generate any sample clock frequency between 300 MHz and 1800 MHz that is a multiple of 1 MHz. Call [AlazarSetCaptureClock\(\)](#) specifying [EXTERNAL_CLOCK_10MHZ_REF](#) as the clock source identifier, the desired sample rate between 300 MS/s and 1800 MS/s, and 1 as the decimation ratio. The sample rate must be a multiple of 1 MHz. For example, the following code fragment shows how to generate a 1.382 GS/s sample clock from a 10 MHz reference:

```
AlazarSetCaptureClock(
    handle, // HANDLE - board handle
    EXTERNAL_CLOCK_10MHZ_REF, // U32 - clock source Id
    1382000000, // U32 - sample rate
    CLOCK_EDGE_RISING, // U32 - clock edge Id
    1 // U32 - decimation
);
```

ATS9371

In 10 MHz PLL external clock mode, the ATS9371 can generate any sample clock frequency between 300 MHz and 1000 MHz that is a multiple of 1 MHz. Call [AlazarSetCaptureClock\(\)](#) specifying [EXTERNAL_CLOCK_10MHZ_REF](#) as the clock source identifier, the desired sample rate between 300 MS/s and 1000 MS/s, and 1 as the decimation ratio. The sample rate must be a multiple of 1 MHz. For example, the following code fragment shows how to generate a 882 MS/s sample clock from a 10 MHz reference:

```
AlazarSetCaptureClock(
    handle, // HANDLE - board handle
    EXTERNAL_CLOCK_10MHZ_REF, // U32 - clock source Id
    882000000, // U32 - sample rate
    CLOCK_EDGE_RISING, // U32 - clock edge Id
    1 // U32 - decimation
);
```

ATS9373

In 10 MHz PLL external clock mode, the ATS9373 can generate any sample clock frequency between 500 MHz and 2000 MHz that is a multiple of 1 MHz in either single or dual channel mode. In addition, it can generate any sample clock frequency between 2000 MHz and 4000 MHz that is a multiple of 2 MHz in single channel mode.

Call `AlazarSetCaptureClock()` specifying `EXTERNAL_CLOCK_10MHZ_REF` as the clock source identifier, the desired sample rate between 300 MS/s and 4000 MS/s, and 1 as the decimation ratio. The sample rate must be a multiple of 1 MHz in dual channel if the frequency is less than or equal to 2000 MHz, and a multiple of 2 MHz if the frequency is above 2000 MHz. For example, the following code fragment shows how to generate a 1.382 GS/s sample clock from a 10 MHz reference:

```
AlazarSetCaptureClock(  
    handle, // HANDLE - board handle  
    EXTERNAL_CLOCK_10MHZ_REF, // U32 - clock source Id  
    1382000000, // U32 - sample rate  
    CLOCK_EDGE_RISING, // U32 - clock edge Id  
    1 // U32 - decimation  
);
```

ATS9440

In 10 MHz PLL external clock mode, the ATS9440 can generate either a 125 MHz or 100 MHz sample clock from an external 10 MHz reference input. The 125 MS/s or 100 MS/s sample data can be decimated by a factor of 2, 4, or any multiple of 5.

Call `AlazarSetCaptureClock()` specifying `EXTERNAL_CLOCK_10MHZ_REF` as the clock source either 125 MHz or 100 MHz as the sample rate, and select a decimation ratio between 1 and 100000. For example, the following code fragment shows how to generate a 25 MS/s sample rate (125 MHz / 5) from a 10 MHz external clock input:

```
AlazarSetCaptureClock(  
    handle, // HANDLE - board handle  
    EXTERNAL_CLOCK_10MHZ_REF, // U32 - clock source Id  
    125000000, // U32 - sample rate Id  
    CLOCK_EDGE_RISING, // U32 - clock edge Id  
    5 // U32 - decimation  
);
```

ATS9462

In 10 MHz PLL external clock mode, the ATS9462 can generate a sample clock between 150 and 180 MHz in 1 MHz steps from an external 10 MHz reference input. Sample data can be decimated by a factor of 1 to 100000.

Call `AlazarSetCaptureClock()` specifying `EXTERNAL_CLOCK_10MHZ_REF` as the clock source, the desired sample rate between 150 and 180 MHz in 1 MHz steps, and the decimation factor of 1 to 100000. Note that the decimation value should be one less than the desired decimation factor. For example, the following code fragment shows how to generate a 15 MS/s sample rate (150 MHz / 10) from a 10 MHz external clock input:

```
AlazarSetCaptureClock(  
    handle, // HANDLE - board handle  
    EXTERNAL_CLOCK_10MHZ_REF, // U32 - clock source Id  
    150000000, // U32 - sample rate Id or value  
    CLOCK_EDGE_RISING, // U32 - clock edge Id  
    9 // U32 - decimation value  
);
```

ATS9625/ATS9626

In 10 MHz PLL external clock mode, the ATS9625/ATS9626 can generate a 250 MHz sample clock from an external 10 MHz reference input. Sample data can be decimated by a factor of 1 to 100000.

Call `AlazarSetCaptureClock()` specifying `EXTERNAL_CLOCK_10MHZ_REF` as the clock source, 250 MHz has the sample rate value, and a decimation ratio of 1 to 100000. For example, the following code fragment shows how to generate a 25 MS/s sample rate (250 MHz / 10) from a 10 MHz external clock input:

```
AlazarSetCaptureClock(  
    handle, // HANDLE - board handle  
    EXTERNAL_CLOCK_10MHZ_REF, // U32 - clock source Id  
    250000000, // U32 - sample rate Id or value  
    CLOCK_EDGE_RISING, // U32 - clock edge Id  
    10 // U32 - decimation value  
);
```

ATS9850

In 10 MHz PLL external clock mode, the ATS9850 generates a 500 MHz sample clock from an external 10 MHz reference input. The 500 MS/s sample data can be decimated by a factor of 1, 2, 4, or any multiple of 10.

Call `AlazarSetCaptureClock()` specifying `EXTERNAL_CLOCK_10MHZ_REF` as the clock source and 500 MHz as the sample rate value, and a decimation of 1, 2, 4, or any multiple of 10 up

to 100000. For example, the following code fragment shows how to generate a 125 MS/s sample rate (500 MHz / 4) from a 10 MHz external clock input:

```
AlazarSetCaptureClock(
    handle, // HANDLE - board handle
    EXTERNAL_CLOCK_10MHZ_REF, // U32 - clock source Id
    500000000, // U32 - sample rate Id or value
    CLOCK_EDGE_RISING, // U32 - clock edge Id
    4 // U32 - decimation value
);
```

ATS9870

In 10 MHz PLL external clock mode, the ATS9870 generates a 1 GHz sample clock from an external 10 MHz reference input. The 1 GS/s sample data can be decimated by a factor of 1, 2, 4, or any multiple of 10.

Call `AlazarSetCaptureClock()` specifying `EXTERNAL_CLOCK_10MHZ_REF` as the clock source and 1 GHz as the sample rate value, and a decimation of 1, 2, 4, or any multiple of 10 up to 100000. For example, the following code fragment shows how to generate a 250 MS/s sample rate (1 GHz / 4) from a 10 MHz external clock input:

```
AlazarSetCaptureClock(
    handle, // HANDLE - board handle
    EXTERNAL_CLOCK_10MHZ_REF, // U32 - clock source Id
    1000000000, // U32 - sample rate Id or value
    CLOCK_EDGE_RISING, // U32 - clock edge Id
    4 // U32 - decimation value
);
```

3.3.2 Input control

AlazarTech digitizers have analog amplifier sections that process the signals input to its analog input connectors before they are sampled by its ADC converters. The gain, coupling, and termination of the amplifier sections should be configured to match the properties of the input signals.

Input range, coupling, and impedance

Call `AlazarInputControl()` to specify the desired input range, termination, and coupling of an input channel. The following code fragment configures input CH A for a range of ± 800 mV, DC coupling, and 50 Ω termination:

```
AlazarInputControl(
    boardHandle, // HANDLE -- board handle
    CHANNEL_A, // U8 -- input channel
    DC_COUPLING, // U32 -- input coupling id
```

(continues on next page)

(continued from previous page)

```

INPUT_RANGE_PM_800_MV, // U32 -- input range id
IMPEDANCE_50_OHM // U32 -- input impedance id
);

```

See [AlazarInputControl\(\)](#) and the board reference manual for a list of input range, coupling, and impedance identifiers appropriate for the board.

Bandwidth filter

Some digitizers have a low pass filters that attenuate signals above about 20 MHz. By default, these filters are disabled. Call [AlazarSetBWLimit\(\)](#) to enable or disable the bandwidth limit filter. The following code fragment enables the CH A bandwidth limit filter:

```

AlazarSetBWLimit (
    boardHandle, // HANDLE -- board handle
    CHANNEL_A, // U32 -- channel identifier
    1 // U32 -- 0 = disable, 1 = enable
);

```

Amplifier bypass

Some digitizer models support “amplifier bypass” mode. In this mode, the analog signal supplied to an input connector is connected directly the ADC driver of that channel, bypassing its amplifier section. Amplifier bypass mode must be enabled in hardware either through DIP switches on the board, or as a factory option. Once enabled in hardware, the following code fragment shows how to configure this option in software:

```

AlazarInputControl(
    handle, // HANDLE -- board handle
    CHANNEL_A, // U8 -- input channel
    DC_COUPLING, // U32 - not used
    INPUT_RANGE_HI_FI, // U32 -- input range id
    IMPEDANCE_50_OHM // U32 - not used
);

```

Note that when amplifier bypass mode option is enabled for an input channel, the channel’s full-scale input range is fixed. The following table lists the nominal full-scale input range values that may be used to convert sample code values to volts.

Model	Full scale input range
ATS460	± 525 mV
ATS660	± 550 mV
ATS9325/ATS9350	± 200 mV
ATS9351	± 400 mV
ATS9462	± 550 mV
ATS9850/ATS9870	± 256 mV

See your board's hardware reference manual for more information about using amplifier bypass.

3.3.3 Trigger control

AlazarTech digitizer boards have a flexible triggering system with two separate trigger engines that can be used independently, or combined together to generate trigger events.

Warning: As opposed to what earlier documentation mentioned, the only way to combine trigger events is with the *OR* operator.

AlazarSetTriggerOperation

Use the `AlazarSetTriggerOperation()` API function to configure each of the two trigger engines, and to specify how they should be used to make the board trigger:

```
RETURN_CODE
AlazarSetTriggerOperation (
    HANDLE handle,
    U32 TriggerOperation,
    U32 TriggerEngineId1,
    U32 SourceId1,
    U32 SlopeId1,
    U32 Level1,
    U32 TriggerEngineId2,
    U32 SourceId2,
    U32 SlopeId2,
    U32 Level2
);
```

The following paragraphs describe each of the function's parameters, and provide examples showing how to use the function.

Trigger engine

The trigger engine identifier parameter specifies which of the two trigger engines you wish to configure. The parameter may have one of the following values:

`TRIG_ENGINE_J`

Configure trigger engine J

`TRIG_ENGINE_K`

Configure trigger engine K

Data source

The data source identifier parameter selects where the specified trigger engine should get its data. Refer to the documentation of the `AlazarSetTriggerOperation()` function for a list of all possible values.

Trigger slope

The trigger slope identifier parameter selects whether rising or falling edges of the trigger source are detected as trigger events.

TRIGGER_SLOPE_POSITIVE

The trigger engine detects a trigger event when sample values from the trigger source rise above a specified level.

TRIGGER_SLOPE_NEGATIVE

The trigger engine detects a trigger event when sample values from the trigger source fall below a specified level.

Trigger level

The trigger level parameter sets the level that the trigger source must rise above, or fall below, for the selected trigger engine to become active. The trigger level is specified as an unsigned 8-bit code that represents a fraction of the full-scale input range of the trigger source; 0 represents the negative full-scale input, 128 represents a 0-volt input, and 255 represents the positive full-scale input. For example, if the trigger source is CH A, and the CH A input range is ± 800 mV, then 0 represents a -800 mV trigger level, 128 represents a 0 V trigger level, and 255 represents $+800$ mV trigger level.

In general, the trigger level value is given by:

$$\text{TriggerLevelCode} = 128 + 127 * \text{TriggerLevelVolts} / \text{InputRangeVolts}.$$

The following table gives examples of how trigger level codes map to trigger levels in volts according to the full-scale input range of the trigger source.

Code	Fraction of input range	Level with ± 1 V range	Level with ± 5 V range
0	-100%	-1V	-5V
64	-50%	-500 mV	-2.5 V
96	-25%	-250 mV	-1.25 V
128	0%	0 V	0 V
160	+25 %	250 mV	1.25 V
192	+50%	+500 mV	+2.5 V
255	+100%	+1V	+5V

Trigger operation

Finally, the trigger operation identifier specifies how the trigger events detected by the trigger engines are combined to make the board trigger. Possible values are:

TRIG_ENGINE_OP_J

The board triggers when trigger engine J detects a trigger event. Events detected by engine K are ignored.

TRIG_ENGINE_OP_K

The board triggers when trigger engine K detects a trigger event. Events detected by engine J are ignored.

TRIG_ENGINE_OP_J_OR_K

The board triggers when a trigger event is detected by any of trigger engines J and K.

AlazarSetTriggerOperation examples

The following code fragment configures a board to trigger when the signal connected to CH A rises above 0V. This example only uses trigger engine J:

```
AlazarSetTriggerOperation(
    handle, // HANDLE -- board handle
    TRIG_ENGINE_OP_J, // U32 -- trigger operation
    TRIG_ENGINE_J, // U32 -- trigger engine id
    TRIG_CHAN_A, // U32 -- trigger source id
    TRIGGER_SLOPE_POSITIVE, // U32 -- trigger slope id
    128, // U32 -- trigger level (128 = 0V)
    TRIG_ENGINE_K, // U32 -- trigger engine id
    TRIG_DISABLE, // U32 -- trigger source id for engine K
    TRIGGER_SLOPE_POSITIVE, // U32 -- trigger slope id
    128 // U32 -- trigger level (0 255)
);
```

The following code fragment configures a board to trigger when the signal connected to CH B rises above 500 mV, or falls below -200 mV, if CH B's input range is $\pm 1V$. This example uses both trigger engine J and K:

```
double inputRange_volts = 1.; //  $\pm 1V$  range
double TriggerLevelJ_volts = .5; // +500 mV trigger level
U32 triggerLevelJ = (U32)(128 + 127 * triggerLevelJ_volts / inputRange_volts);
double triggerLevelK_volts = -.2; // -200 mV trigger level
U32 triggerLevelK = (U32)(128 + 127 * triggerLevelK_volts / inputRange_volts);
AlazarSetTriggerOperation(
    handle, // HANDLE -- board handle
    TRIG_ENGINE_OP_J_OR_K, // U32 -- trigger operation
    TRIG_ENGINE_J, // U32 -- trigger engine id
    TRIG_CHAN_B, // U32 -- trigger source id
    TRIGGER_SLOPE_POSITIVE, // U32 -- trigger slope id
    triggerLevelJ, // U32 -- trigger level from 0 to 255
    TRIG_ENGINE_K, // U32 -- trigger engine id
```

(continues on next page)

(continued from previous page)

```

TRIG_CHAN_B, // U32 -- trigger source id for engine K
TRIGGER_SLOPE_NEGATIVE, // U32 -- trigger slope id
triggerLevelK, // U32 -- trigger level from 0 to 255
);

```

External trigger

AlazarTech digitizer boards can trigger on a signal connected to its TRIG IN connector. To use an external trigger input:

- Call `AlazarSetTriggerOperation()` with `TRIG_EXTERNAL` as the trigger source identifier of at least one of the trigger engines; and
- Call `AlazarSetExternalTrigger()` to select the range and coupling of the external trigger input.

The following code fragment configures a board to trigger when the signal connected to the TRIG IN falls below +2 V, assuming the signal's range is less than $\pm 5V$ with DC coupling:

```

// Calculate the trigger level code from the level and range
double triggerLevel_volts = 2.; // trigger level
double triggerRange_volts = 5.; // input range
U32 triggerLevel_code =
(U32)(128 + 127 * triggerLevel_volts / triggerRange_volts);

// Configure trigger engine J to generate a trigger event
// on the falling edge of an external trigger signal.
AlazarSetTriggerOperation(
    handle, // HANDLE -- board handle
    TRIG_ENGINE_OP_J, // U32 -- trigger operation
    TRIG_ENGINE_J, // U32 -- trigger engine id
    TRIG_EXTERNAL, // U32 -- trigger source id
    TRIGGER_SLOPE_NEGATIVE, // U32 -- trigger slope id
    triggerLevel, // U32 -- trigger level (0 255)
    TRIG_ENGINE_K, // U32 -- trigger engine id
    TRIG_DISABLE, // U32 -- trigger source id for engine K
    TRIGGER_SLOPE_POSITIVE, // U32 -- trigger slope id
    128 // U32 -- trigger level (0 255)
);

// Configure the external trigger input to +/-5V range,
// with DC coupling
AlazarSetExternalTrigger(
    handle, // HANDLE -- board handle
    DC_COUPLING, // U32 -- coupling id
    ETR_5V // U32 -- external range id
);

```

Trigger timeout

AlazarTech digitizer boards can be configured to automatically trigger when the board is waiting for a trigger event, but no trigger events arrive after a specified time interval. This behavior is similar to the “automatic” trigger mode of oscilloscopes, and may be useful to capture waveforms when trigger conditions are unknown. Call `AlazarSetTriggerTimeout()` to specify the amount of time that a board should wait for a hardware trigger event before automatically generating a software trigger event and, as a result, acquiring one record.

Note: The trigger timeout value should be set to zero once stable trigger parameters have been found. Otherwise, a board may generate unexpected trigger events if the trigger timeout interval expires before a hardware trigger event occurs.

The following code fragment configures a board to automatically trigger and acquire one record if it does not receive a trigger event after some time:

```
AlazarSetTriggerTimeout(  
    boardHandle, // HANDLE -- board handle  
    1000         // U32    -- Timeout in ticks  
);
```

The following code fragment configures a board to wait forever for trigger events:

```
AlazarSetTriggerTimeout(  
    boardHandle, // HANDLE -- board handle  
    0           // U32    -- timeout in ticks  
);
```

Trigger delay

An AlazarTech digitizer board can be configured to wait for a specified amount of time after it receives a trigger event before capturing a record for the trigger. Call `AlazarSetTriggerDelay()` to specify a time, in sample clock periods, to wait after receiving a trigger event for a record before capturing samples for that record. The following code fragment shows how to set a trigger delay of 1 ms, given a sample rate of 100 MS/s:

```
double triggerDelay_sec = 1.e-3; // 1 ms  
double samplesPerSec = 100.e6; // 100 MS/s  
U32 triggerDelay_samples =  
(U32)(triggerDelay_sec * samplesPerSec + 0.5);  
AlazarSetTriggerDelay(  
    boardHandle, // HANDLE -- board handle  
    triggerDelay_samples // U32 -- trigger delay in samples  
);
```

3.3.4 AUX I/O

AlazarTech digitizer boards with an AUX I/O connector can be configured to supply a 5V TTL-level output signal, or to receive a TTL-level input signal on this connector. Use `AlazarConfigureAuxIO()` to configure the function of the AUX I/O connector.

The ATS9440 has two AUX I/O connectors: AUX I/O 1 and AUX I/O 2. AUX I/O 1 is configured by firmware as a trigger output signal, while AUX I/O 2 is configured by software using `AlazarConfigureAuxIO()`. A custom FPGA is required to change the operation of AUX I/O 1.

The ATS9625 and ATS9626 have two AUX I/O connectors: AUX1 and AUX2. AUX1 is configured by software using `AlazarConfigureAuxIO()`, while AUX2 is configured by the main FPGA as a trigger output signal by default. AUX2 can be controlled by its user-programmable FPGA as desired by the FPGA designer.

Trigger output

The AUX I/O connector can be configured to supply a trigger output signal, where the edge of the trigger output signal is synchronized with the edge of the sample clock. Note that this is the default power-on mode for the AUX I/O connector. The following code fragment configures the AUX I/O connector as a trigger output signal:

```
AlazarConfigureAuxIO(  
    handle, // HANDLE -- board handle  
    AUX_OUT_TRIGGER, // U32 -- mode  
    0 // U32 -- parameter  
);
```

Pacer output

The AUX I/O connector can be configured to output the sample clock divided by a programmable value. This option may be used to generate a clock signal synchronized with the sample clock of the digitizer board. The following code fragment generates a 10 MHz signal on an AUX I/O connector, given a sample rate of 180 MS/s:

```
AlazarConfigureAuxIO(  
    handle, // HANDLE -- board handle  
    AUX_OUT_PACER, // U32 -- mode  
    18 // U32 - sample clock divider  
);
```

Note that the sample rate divider value must be greater than 2, and that the signal output may be limited by the bandwidth of the output's TTL drivers.

Digital output

The AUX I/O connector can be configured to output a TTL high or low signal. This mode allows a programmer to use the AUX I/O connector as a general purpose digital output. The following code fragment configures the AUX I/O connector as a digital output:

```
AlazarConfigureAuxIO(  
    handle, // HANDLE -- board handle  
    AUX_OUT_SERIAL_DATA, // U32 -- mode  
    0 // U32 - 0 = low, 1 = high  
);
```

Trigger enable input

The AUX I/O connector can be configured as an AutoDMA trigger enable input signal. When enabled, a board will:

- Wait for a rising or falling edge on the AUX I/O.
- Wait for the number of trigger events necessary to capture the number of “records per buffer” in one AutoDMA segment specified at the start of the acquisition.
- Repeat.

The following code fragment configures the AUX I/O connector to acquire “records per buffer” records after it receives the rising edge of a TTL pulse connected on the AUX I/O connector:

```
AlazarConfigureAuxIO(  
    handle, // HANDLE -- board handle  
    AUX_IN_TRIGGER_ENABLE, // U32 -- mode  
    TRIGGER_SLOPE_POSITIVE // U32 -- parameter  
);
```

See [Scanning Applications](#) for more information.

Digital input

The AUX I/O connector can be configured to read the TTL level of a signal input to the AUX connector. This mode allows a programmer to use the AUX I/O connector as a general-purpose digital input. The following code fragment configures the AUX I/O connector as a digital input:

```
AlazarConfigureAuxIO(  
    handle, // HANDLE -- board handle  
    AUX_IN_AUXILIARY, // U32 -- mode  
    0 // U32 - not used  
);
```

Once configured as a serial input, the following code fragment reads the AUX input level:

```

long level;
AlazarGetParameter(
    handle, // HANDLE -- board handle
    0, // U8 -- channel
    GET_AUX_INPUT_LEVEL, // U32 -- parameter
    &level // long* - 0 = low, 1 = high
);

```

3.3.5 Data packing

By default, all the boards that have more than 8-bit per sample sampling transfer data to the host computer with 2 bytes (16 bit) per sample. This behavior can be changed on some boards by packing the data, either to 8- or 12-bits per sample. This is done by calling the `AlazarSetParameter` function with the `PACK_MODE` parameter and a packing option (either `PACK_DEFAULT`, `PACK_8_BITS_PER_SAMPLE` or `PACK_12_BITS_PER_SAMPLE`). The parameter must be set before calling `AlazarBeforeAsyncRead`.

For a list of boards that implement 8-bit packing, 12-bit packing and both; please refer to *Table 9 – Miscellaneous Features Support*.

3.3.6 Dual edge sampling

Some AlazarTech digitizers are capable of dual edge sampling (DES), meaning that sample data is acquired both at the rising and falling edge of the clock signal. This mode can apply both to internal and external clocks. For example, ATS9373 is capable of 2 GS/s sampling in non-DES mode, and 4 GS/s in DES mode. When using the internal clock, DES sampling is activated automatically. Data must be acquired from channel A only. To use DES sampling in external clock mode, one must call `AlazarSetParameter` as follows *before* calling `AlazarSetCaptureClock()`:

```

AlazarSetParameterUL(
    handle, // HANDLE -- board handle
    channelMask, // U8 -- channel to acquire
    SET_ADC_MODE,
    ADC_MODE_DES
);

```

Programs that wish to use DES-capable digitizers in non-DES mode (i.e. ATS9373 at sampling frequencies at or below 2GS/s) do not need to be modified.

3.3.7 NPT footers

Footers can be included to the data and contain additional information about the acquisition of each record. The footers include a timestamp, the record number in the current acquisition, a frame count and the state of the AUX I/O signal at the time of the acquisition. As the name implies, this option is only available in NPT acquisition mode.

Depending if on-FPGA FFT is used or not, the function to retrieve the NPT footers and their position in memory is different. If FFT is not enabled, NPT footers will *replace* the last 16 bytes of a record, leading to a loss of a few data points. These NPT footers are labeled Time-Domain to highlighting the fact that FFT is not used. When one channel is enabled, the last 8 samples of the data will be removed. When two channels are enabled, only one footer will be appended per record and will take the place of the last 4 samples from each channel.

When using on-FPGA FFT, a 128-byte word will be appended to each record. The last 16 bytes of this 128-byte word contain the footer.

Here is how to enable NPT footers:

- Connect the start of frame signal to the AUX I/O connector.
- Append the flag `ADMA_ENABLE_RECORD_FOOTERS` to the options passed to `AlazarBeforeAsyncRead()` by using a binary OR (`|`). Make sure the acquisition mode is set to `ADMA_NPT` and FFT processing is enabled if applicable.
- Call `AlazarConfigureAuxIO()` specifying `AUX_IN_AUXILIARY` as the mode with `0` as parameter.

The format of NPT footers varies a lot depending on digitizer model, acquisition configuration, etc. To extract the NPT footers, a separate open-source library should be used. This external library is available at <https://github.com/alazartech/ats-footers>.

3.4 Acquiring data

AlazarTech digitizers may be configured to acquire in one of the following modes:

- *Dual port AutoDMA acquisition* mode acquires to on-board memory while, at the same time, transferring data from on-board memory to application buffers.
- *Single port acquisition* mode acquires data to on-board memory and then, after the acquisition is complete, transfers data from on-board memory to application buffers.

Note: Dual-port AutoDMA is the recommended acquisition mode for data acquisition with AlazarTech digitizers, because it offers much better performance and flexibility. Single-port acquisitions should only be used with PCI bus digitizers that do not have dual-port memory (i.e. ATS460 and ATS860 without dual-port memory upgrade, ATS310, ATS330, ATS850).

3.4.1 Dual port AutoDMA acquisition

AutoDMA allows a board to capture sample data to on-board dual-port memory while – at the same time – transferring sample data from on-board dual-port memory to a buffer in host memory. Data acquisition and data transfer are done in parallel, so any trigger events that occur while the board is transferring data will not be missed.

AutoDMA may be used if:

- A board has dual-port or FIFO on-board memory.
- An application acquires at an average rate, in MB/s, that is less than maximum transfer rate of your board's PCI or PCIe host bus interface.

AutoDMA must be used if:

- A board has FIFO on-board memory.
- An application cannot miss trigger events that occur while it transfers data to host memory, or re-arms for another acquisition.
- An application acquires more sample points or records than can be stored in on-board memory.

Applications such as ultrasonic testing, OCT, radar, and imaging should use AutoDMA. An AutoDMA acquisition is divided into segments. AutoDMA hardware on a board transfers sample data, one segment at a time, from on-board memory to a buffer in host memory. There may be an unlimited number of segments in an AutoDMA acquisition, so a board can be armed to make an acquisition of infinite duration. There are four AutoDMA operating modes:

Traditional AutoDMA

This mode acquires multiple records, one per trigger event. Each record may contain samples before and after its trigger event. Each buffer contains one or more records. A record header may optionally precede each record. Supports low trigger repeat rates.

NPT AutoDMA

Acquires multiple records, one per trigger event. Some boards support a very limited number of pre-trigger samples. Otherwise, only post-trigger samples are possible. Each buffer contains one or more record. Supports high trigger repetition rates.

Triggered streaming AutoDMA

Acquires a single, gapless record spanning one or more DMA buffers. Each DMA buffer then contains only a segment of the record. This mode waits for a trigger event before acquiring the record.

Continuous streaming AutoDMA

Acquires a single, gapless record spanning one or more DMA buffers. Each DMA buffer then contains only a segment of the record. This mode does not wait for a trigger event before acquiring the record.

To make an AutoDMA acquisition, an application must:

- Specify the AutoDMA mode, samples per record, records per buffer, and records per acquisition.
- Arm the board to start the acquisition.
- Wait for an AutoDMA buffer to be filled, process the buffer, and repeat until the acquisition is complete.

Note: An additional acquisition mode called Synchronous AutoDMA was available in addition to the modes presented here in former versions of the SDK. Support for this API was removed with ATSApi version 6.0.0. Refer to Annex 1 for more information.

Traditional AutoDMA

Use traditional mode to acquire multiple records – one per trigger event – with sample points after, and optionally before, the trigger event in each record. A record header may optionally precede each record in the AutoDMA buffer. The programmer specifies the number of samples per record, records per buffer, and buffers in the acquisition. Traditional AutoDMA supports low trigger repeat rates. For high trigger repeat rates, use NPT AutoDMA mode. Digitizers with four analog input channels do not support 3-channel operation, and require sample interleave to allow for high transfer rates from on-board memory.

Each buffer is organized in memory as follows if a board has on-board memory. R_{xy} represents a contiguous array of samples from record x of channel y .

Enabled channels	Buffer organization
CH A	$R_{1A}, R_{2A}, R_{3A}, \dots R_{nA}$
CH B	$R_{1B}, R_{2B}, R_{3B} \dots R_{nB}$
CH A and CH B	$R_{1A}, R_{1B}, R_{2A}, R_{2B}, R_{3A}, R_{3B} \dots R_{nA}, R_{nB}$
CH C	$R_{1C}, R_{2C}, R_{3C} \dots R_{nC}$
CH A and CH C	$R_{1A}, R_{1C}, R_{2A}, R_{2C}, R_{3A}, R_{3C} \dots R_{nA}, R_{nC}$
CH B and CH C	$R_{1B}, R_{1C}, R_{2B}, R_{2C}, R_{3B}, R_{3C} \dots R_{nB}, R_{nC}$
CH D	$R_{1D}, R_{2D}, R_{3D} \dots R_{nD}$
CH A and CH D	$R_{1A}, R_{1D}, R_{2A}, R_{2D}, R_{3A}, R_{3D} \dots R_{nA}, R_{nD}$
CH B and CH D	$R_{1B}, R_{1D}, R_{2B}, R_{2D}, R_{3B}, R_{3D} \dots R_{nB}, R_{nD}$
CH C and CH D	$R_{1C}, R_{1D}, R_{2C}, R_{2D}, R_{3C}, R_{3D} \dots R_{nC}, R_{nD}$
CH A, CH B, CH C and CH D	$R_{1A}, R_{1B}, R_{1C}, R_{1D}, R_{2A}, R_{2B}, R_{2C}, R_{2D}, R_{3A}, R_{3B}, R_{3C}, R_{3D} \dots R_{nA}, R_{nB}, R_{nC}, R_{nD}$

Each buffer is organized in memory as follows if a board does not have on-board memory, or if sample interleave is enabled. R_{xy} represents a contiguous array of samples from record x of channel y , $R_{x[uv]}$ represents interleaved samples from record x of channels u and v , and $R_{x[uvyz]}$ represents interleaved samples from channels u , v , y , and z .

Enabled channels	Buffer organization
CH A	R1A, R2A, R3A, ... RnA
CH B	R1B, R2B, R3B ... RnB
CH A and CH B	R1[ABAB...], R2[ABAB...], ... Rn[ABAB...]
CH C	R1C, R2C, R3C ... RnC
CH A and CH C	R1[ACAC...], R2[ACAC...], ... Rn[ACAC...]
CH B and CH C	R1[BCBC...], R2[BCBC...], ... Rn[BCBC...]
CH D	R1D R2D, R3D ... RnD
CH A and CH D	R1[ADAD...], R2[ADAD...], ... Rn[ADAD...]
CH B and CH D	R1[BDBD...], R2[BDBD...], ... Rn[BDBD...]
CH C and CH D	R1[CD CD...], R2[CD CD...], ... Rn[CD CD...]
CH A, CH B, CH C and CH C	R1[ABCDABDC ...], R2[ABDCABDC ...], ... Rn[ABDCABDC...]

Note: Some digitizer boards can be configured with the parallel DMA buffer data transfer scheme. When this feature is active, each DMA buffer contains data associated with a single input channel. The first buffer acquired contains exclusively data from channel A, the second contains data from channel B, etc. This feature is only available for multi-channel acquisitions on specific digitizers.

See “%ATS_SDK_DIR%\Samples\DualPort\TR” for a sample program that demonstrates how to make an AutoDMA acquisition in Traditional mode.

If record headers are enabled, then a 16-byte record header will precede each record in an AutoDMA buffer. The record header contains a record timestamp, as well as acquisition metadata. See [Record headers and timestamps](#) below for a discussion of AutoDMA record headers.

NPT AutoDMA

Use NPT mode to acquire multiple records – one per trigger event – with no sample points before the trigger event in each record, and with no record headers. The programmer specifies the number of samples per record, records per buffer, and buffers in the acquisition. Note that NPT mode is highly optimized, and supports higher trigger repeats rate than possible in Traditional mode. Digitizers with four analog input channels do not support 3-channel operation, and require sample interleave to allow for high transfer rates from on-board memory.

Each buffer is organized in memory as follows if a board has on-board memory. Rxy represents a contiguous array of samples from record x of channel y.

Enabled channels	Buffer organization
CH A	R1A, R2A, R3A, ... RnA
CH B	R1B, R2B, R3B ... RnB
CH A and CH B	R1A, R2A, R3A ... RnA, R1B, R2B, R3B ... RnB
CH C	R1C, R2C, R3C, ... RnC
CH A and CH B	R1A, R2A, R3A ... RnA, R1B, R2B, R3B ... RnB
CH B and CH C	R1B, R2B, R3B ... RnB, R1C, R2C, R3C ... RnC
CH D	R1D, R2D, R3D, ... RnD
CH A and CH D	R1A, R2A, R3A ... RnA, R1D, R2D, R3D ... RnD
CH B and CH D	R1B, R2B, R3B ... RnB, R1D, R2D, R3D ... RnD
CH C and CH D	R1C, R2C, R3C ... RnC, R1D, R2D, R3D ... RnD
CH A, CH B, CH C, and CH D	R1A, R2A, R3A ... RnA, R1B, R2B, R3B ... RnB, R1C, R2C, R3C ... RnC, R1D, R2D, R3D ... RnD

Each buffer is organized in memory as follows if a board does not have on-board memory, or if sample interleave is enabled. R_{xy} represents a contiguous array of samples from record x of channel y , $R_{x[uv]}$ represents interleaved samples from record x of channels u and v , and $R_{x[uvyz]}$ represents interleaved samples from record x of channels u , v , y , and z .

Enabled channels	Buffer organization
CH A	R1A, R2A, R3A, ... RnA
CH B	R1B, R2B, R3B ... RnB
CH A and CH B	R1[ABAB...], R2[ABAB...], ... Rn[ABAB...]
CH C	R1C, R2C, R3C ... RnC
CH A and CH C	R1[ACAC...], R2[ACAC...], ... Rn[ACAC...]
CH B and CH C	R1[BCBC...], R2[BCBC...], ... Rn[BCBC...]
CH D	R1D R2D, R3D ... RnD
CH A and CH D	R1[ADAD...], R2[ADAD...], ... Rn[ADAD...]
CH B and CH D	R1[BDBD...], R2[BDBD...], ... Rn[BDBD...]
CH C and CH D	R1[CD CD...], R2[CD CD...], ... Rn[CD CD...]
CH A, CH B, CH C and CH D	R1[ABCDABCD ...], R2[ABCDABCD ...], ... Rn[ABCDABCD...]

Note: Some digitizer boards can be configured with the parallel DMA buffer data transfer scheme. When this feature is active, each DMA buffer contains data associated with a single input channel. The first buffer acquired contains exclusively data from channel A, the second contains data from channel B, etc. This feature is only available for multi-channel acquisitions on specific digitizers.

See “%ATS_SDK_DIR%\Samples\DualPort\NPT” for a sample program that demonstrates how to make an AutoDMA acquisition in NPT mode.

Continuous streaming AutoDMA

Use continuous streaming mode to acquire a single, gapless record that spans multiple buffers without waiting for a trigger event to start the acquisition. The programmer specifies the number of samples per buffer, and buffers per acquisition. Each buffer is organized as follows if a board has on-board memory. R1x represents a contiguous array of samples from channel x.

Enabled channels	Buffer organization
CH A	R1A
CH B	R1B
CH A and CH B	R1A, R1B
CH C	R1C
CH A and CH C	R1A, R1C
CH B and CH C	R1B, R1C
CH D	R1D
CH A and CH D	R1A, R1D
CH B and CH D	R1B, R1D
CH C and CH D	R1C, R1D
CH A, CH B, CH C and CH D	R1A, R1B, R1C, R1D

Each buffer is organized as follows if a board does not have on-board memory, or if sample interleave is enabled. R1x represents a contiguous array of samples from channel x, R1[uv] represents samples interleaved from channels u and v, and R1[uvyz] represents samples interleaved from channels u, v, y, and z.

Enabled channels	Buffer organization
CH A	R1A
CH B	R1B
Both CH A and CH B	R1[ABAB...]
CH C	R1C
CH A and CH C	R1[ACAC...]
CH B and CH C	R1[BCBC...]
CH D	R1D
CH A and CH D	R1[ADAD...]
CH B and CH D	R1[BDBD...]
CH C and CH D	R1[CD CD...]
CH A, CH B, CH C and CH D	R1[ABCDABCD ...]

Note: Some digitizer boards can be configured with the parallel DMA buffer data transfer scheme. When this feature is active, each DMA buffer contains data associated with a single input channel. The first buffer acquired contains exclusively data from channel A, the second contains data from channel B, etc. This feature is only available for multi-channel

acquisitions on specific digitizers.

See “%ATS_SDK_DIR%\Samples\DualPort\CS” for a sample program that demonstrates how to make an AutoDMA acquisition in continuous streaming mode.

Triggered streaming AutoDMA

Use triggered streaming mode to acquire a single, gapless record that spans two or more buffers after waiting for a trigger event to start the acquisition. The programmer specifies the number of samples in each buffer, and buffers in the acquisition. Each buffer is organized as follows if a board has on-board memory. R1x represents a contiguous array of samples from channel x.

Enabled channels	Buffer organization
CH A	R1A
CH B	R1B
CH A and CH B	R1A, R1B
CH C	R1C
CH A and CH C	R1A, R1C
CH B and CH C	R1B, R1C
CH D	R1D
CH A and CH D	R1A, R1D
CH B and CH D	R1B, R1D
CH C and CH D	R1C, R1D
CH A, CH B, CH C and CH D	R1A, R2B, R1C, R1D

Each buffer is organized as follows if a board does not have on-board memory, or if sample interleave is enabled. R1x represents a contiguous array of samples from channel x, R1[uv] represents samples interleaved from channels u and v, and R1[uvyz] represents samples interleaved from channels u, v, y, and z.

Enabled channels	Buffer organization
CH A	R1A
CH B	R1B
Both CH A and CH B	R1[ABAB...]
CH C	R1C
CH A and CH C	R1[ACAC...]
CH B and CH C	R1[BCBC...]
CH D	R1D
CH A and CH D	R1[ADAD...]
CH B and CH D	R1[BDBD...]
CH C and CH D	R1[CD CD...]
CH A, CH B, CH C and CH D	R1[ABCDABCD ...]

Note: Some digitizer boards can be configured with the parallel DMA buffer data transfer scheme. When this feature is active, each DMA buffer contains data associated with a single input channel. The first buffer acquired contains exclusively data from channel A, the second contains data from channel B, etc. This feature is only available for multi-channel acquisitions on specific digitizers.

See “%ATS_SDK_DIR%\Samples\DualPort\TS” for a sample program that demonstrates how to make a triggered streaming AutoDMA acquisition.

Record headers and timestamps

In traditional AutoDMA mode, a 16-byte record header may optionally precede each record in a buffer. When record headers are enabled, the following table shows the buffer layout if a board has on-board memory. Record headers are not supported if a board does not have on-board memory. Rxy represents a contiguous array of samples from record x of channel y, and Hxy is a 16-byte record header from record x of channel y.

Enabled channels	Buffer organization
CH A	H1A, R1A, H2A, R2A ... HnA, RnA
CH B	H1B, R1B, H2B, R2B ... HnB, RnB
CH A and CH B	H1A, R1A, H1B, R1B, H2A, R2A, H2B, R2B... HnA, RnA, HnB, RnB
CH C	H1C, R1C, H2C, R2C ... HnC, RnC
CH A and CH C	H1A, R1A, H1C, R1C, H2A, R2A, H2C, R2C... HnA, RnA, HnC, RnC
CH B and CH C	H1B, R1B, H1C, R1C, H2B, R2B, H2C, R2C... HnB, RnB, HnC, RnC
CH D	H1D, R1D, H2D, R2D ... HnD, RnD
CH A and CH D	H1A, R1A, H1D, R1D, H2A, R2A, H2D, R2D... HnA, RnA, HnD, RnD
CH B and CH D	H1B, R1B, H1D, R1D, H2B, R2B, H2D, R2D... HnB, RnB, HnD, RnD
CH C and CH D	H1C, R1C, H1D, R1D, H2C, R2C, H2D, R2D... HnC, RnC, HnD, RnD
CH A, CH B, CH C and CH D	H1A, R1A, H1B, R1B, H1C, R1C, H1D, R1D, H2A, R2A, H2B, R2B H2C, R2C, H2D, R2D... HnA, RnA, HnB, RnB, HnC, RnC, HnD, RnD

Record headers

A record header is a 16-byte structure defined in AlazarApi.h as follows:

```
struct _HEADER0 {
    unsigned int SerialNumber:18; // bits 17..0
    unsigned int SystemNumber:4; // bits 21..18
    unsigned int WhichChannel:1; // bit 22
    unsigned int BoardNumber:4; // bits 26..23
    unsigned int SampleResolution:3; // bits 29..27
    unsigned int DataFormat:2; // bits 31..30
```

(continues on next page)

(continued from previous page)

```
};

struct _HEADER1 {
    unsigned int RecordNumber:24; // bits 23..0
    unsigned int BoardType:8; // bits 31..24
};

struct _HEADER2 {
    U32 TimeStampLowPart; //bits 31..0
};

struct _HEADER3 {
    unsigned int TimeStampHighPart:8; // bits 7..0
    unsigned int ClockSource:2; // bits 9..8
    unsigned int ClockEdge:1; // bit 10
    unsigned int SampleRate:7; // bits 17..11
    unsigned int InputRange:5; // bits 22..18
    unsigned int InputCoupling:2; // bits 24..23
    unsigned int InputImpedance:2; // bits 26..25
    unsigned int ExternalTriggered:1; // bit 27
    unsigned int ChannelBTriggered:1; // bit 28
    unsigned int ChannelATriggered:1; // bit 29
    unsigned int TimeOutOccurred:1; // bit 30
    unsigned int ThisChannelTriggered:1; // bit 31
};

typedef struct _ALAZAR_HEADER {
    struct _HEADER0 hdr0;
    struct _HEADER1 hdr1;
    struct _HEADER2 hdr2;
    struct _HEADER3 hdr3;
} *PALAZAR_HEADER;

typedef struct _ALAZAR_HEADER ALZAR_HEADER;
```

See `ALAZAR_HEADER` for more information about each of the fields of this structure. See “`%ATS_SDK_DIR%\Samples\DualPort\TR_Header`” for a full sample program that demonstrates how to make an AutoDMA acquisition in Traditional mode with record headers.

Record timestamps

AlazarTech digitizer boards include a high-speed 40-bit counter that is clocked by the sample clock source scaled by a board specific divider. When a board receives a trigger event to capture a record to on-board memory, it latches the value of this counter. This timestamp value gives the time, relative to when the counter was reset, when the trigger event for this record occurred. By default, this counter is reset to zero at the start of each acquisition. Use `AlazarResetTimeStamp()` to control when the record timestamp counter is reset. The following code fragment demonstrates how to extract the timestamp from a record header, and convert the value from counts to seconds:

```

double samplesPerTimestampCount = 2; // board specific constant
double samplesPerSec = 100.e6; // sample rate
void* pRecord; // points to record header in buffer
ALAZAR_HEADER *pHeader = (ALAZAR_HEADER*) pRecord;
__int64 timestamp_counts;
timestamp_counts = (INT64) pHeader->hdr2.TimeStampLowPart;
timestamp_counts = timestamp_counts |
(((__int64) (pHeader->hdr3.TimeStampHighPart & 0x0fff)) << 32);
double timestamp_sec = samplesPerTimestampCount *
timestamp_counts / samplesPerSec;

```

Call `AlazarGetParameter()` with the `GET_SAMPLES_PER_TIMESTAMP_CLOCK` parameter to determine the board specific “samples per timestamp count” value. [Samples per record requirements](#) lists these values. See “%ATS_SDK_DIR%\Samples\DualPort\TR_Header” for a full sample program that demonstrates how to make an AutoDMA acquisition in Traditional mode with record headers, and convert the timestamp to seconds.

AutoDMA acquisition flow

The AutoDMA functions allow an application to add user-defined number of buffers to a list of buffers available to be filled by a board, and to wait for the board to receive sufficient trigger events to fill the buffers with sample data. The board uses AutoDMA to transfer data directly into a buffer without making any intermediate copies in memory. As soon as one buffer is filled, the driver automatically starts an AutoDMA transfer into the next available buffer.

AlazarPostBuffer

C/C++ applications should call `AlazarPostAsyncBuffer()` to make buffers available to be filled by the board, and `AlazarWaitAsyncBufferComplete()` to wait for the board to receive sufficient trigger events to fill the buffers. The following code fragment outlines the steps required to make an AutoDMA acquisition using `AlazarPostAsyncBuffer()` and `AlazarWaitAsyncBufferComplete()`:

```

// Configure the board to make an AutoDMA acquisition
AlazarBeforeAsyncRead(
    handle, // HANDLE -- board handle
    channelMask, // U32 -- enabled channel mask
    -(long)preTriggerSamples, // long -- trigger offset
    samplesPerRecord, // U32 -- samples per record
    recordsPerBuffer, // U32 -- records per buffer
    recordsPerAcquisition, // U32 -- records per acquisition
    flags // U32 -- AutoDMA mode and options
);

// Add two or more buffers to a list of buffers
// available to be filled by the board
for (i = 0; i < BUFFER_COUNT; i++) {

```

(continues on next page)

(continued from previous page)

```
AlazarPostAsyncBuffer(  
    handle, // HANDLE -- board handle  
    BufferArray[i], // void* -- buffer pointer  
    BytesPerBuffer // U32 -- buffer length in bytes  
);  
}  
  
// Arm the board to begin the acquisition  
AlazarStartCapture(handle);  
  
// Wait for each buffer in the acquisition to be filled  
U32 buffersCompleted = 0;  
while (buffersCompleted < buffersPerAcquisition) {  
    // Wait for the board to receives sufficient trigger events  
    // to fill the buffer at the head of its list of  
    // available buffers.  
    U32 bufferIndex = buffersCompleted % BUFFER_COUNT;  
    U16* pBuffer = BufferArray[bufferIndex];  
    AlazarWaitAsyncBufferComplete(handle, pBuffer, timeout_ms);  
    buffersCompleted++;  
  
    // The buffer is full, process it.  
    // Note that while the application processes this buffer,  
    // the board is filling the next available buffer  
    // as trigger events arrive.  
    ProcessBuffer(pBuffer, bytesPerBuffer);  
  
    // Add the buffer to the end of the list of buffers  
    // available to be filled by this board. The board will  
    // fill it with another segment of the acquisition after  
    // all of the buffers preceding it have been filled.  
    AlazarPostAsyncBuffer(handle, pBuffer, bytesPerBuffer);  
}  
  
// Abort the acquisition and release resources.  
// This function must be called after an acquisition.  
AlazarAbortAsyncRead(boardHandle);
```

See “%ATS_SDK_DIR%\Samples\DualPort\NPT” for a full sample program that demonstrates make an AutoDMA acquisition using `AlazarPostAsyncBuffer`.

ADMA_ALLOC_BUFFERS

C#, and LabVIEW applications may find it more convenient to allow the API to allocate and manage a list of buffers available to be filled by the board. These applications should call `AlazarBeforeAsyncRead()` with the `ADMA_ALLOC_BUFFERS` option selected in the “Flags” parameter. This option will cause the API to allocate and manage a list of buffers available to be filled by the board. The application must call `AlazarWaitNextAsyncBufferComplete()` to wait for a buffer to be filled. When the board receives sufficient trigger events to fill a buffer, the API will copy the data from the internal buffer to the user-supplied buffer. The following

code fragment outlines how make an AutoDMA acquisition using the `ADMA_ALLOC_BUFFERS` flag and `AlazarWaitNextAsyncBufferComplete()`:

```
// Allow the API to allocate and manage AutoDMA buffers
flags |= ADMA_ALLOC_BUFFERS;

// Configure a board to make an AutoDMA acquisition
AlazarBeforeAsyncRead(
    handle, // HANDLE -- board handle
    channelMask, // U32 -- enabled channel mask
    -(long)preTriggerSamples, // long -- trigger offset
    samplesPerRecord, // U32 -- samples per record
    recordsPerBuffer, // U32 -- records per buffer
    recordsPerAcquisition, // U32 -- records per acquisition
    flags // U32 -- AutoDMA mode and options
);

// Arm the board to begin the acquisition
AlazarStartCapture(handle);

// Wait for each buffer in the acquisition to be filled
RETURN_CODE retCode = ApiSuccess;
while (retCode == ApiSuccess) {
    // Wait for the board to receive sufficient
    // trigger events to fill an internal AutoDMA buffer.
    // The API will copy data from the internal buffer
    // to the user-supplied buffer.
    retCode =
    AlazarWaitNextAsyncBufferComplete(
        handle, // HANDLE -- board handle
        pBuffer, // void* -- buffer to receive data
        bytesToCopy, // U32 -- bytes to copy into buffer
        timeout_ms // U32 -- time to wait for buffer
    );

    // The buffer is full, process it
    // Note that while the application processes this buffer,
    // the board is filling the next available internal buffer
    // as trigger events arrive.
    ProcessBuffer(pBuffer, bytesPerBuffer);
}

// Abort the acquisition and release resources.
// This function must be called after an acquisition.
AlazarAbortAsyncRead(boardHandle);
```

See “%ATS_SDK_DIR%\Samples\DualPort\CS_WaitNextBuffer” for a full sample program that demonstrates make an AutoDMA acquisition using `ADMA_ALLOC_BUFFERS`. An application can get or set the number of DMA buffers allocated by the API by calling `AlazarGetParameter()` or `AlazarSetParameter()` with the parameter `SETGET_ASYNC_BUFFCOUNT`.

Note that applications may combine `ADMA_ALLOC_BUFFERS` with options to perform operations that would be difficult in high-level programming languages like LabVIEW. They include:

- Data normalization – This option enables the API to process sample data so that the data always has the same arrangement in the application buffer, independent of AutoDMA mode. See [ADMA_GET_PROCESSED_DATA](#) for more information.
- Disk streaming – This option allows the API to use high-performance disk I/O functions to stream buffer data to files. See [AlazarCreateStreamFile\(\)](#) below for more information.

AlazarAsyncRead

Some C/C++ applications under Windows may require waiting for an event to be set to the signaled state to indicate when an AutoDMA buffer is full. These applications should use the [AlazarAsyncRead\(\)](#) API. The following code fragment outlines how use [AlazarAsyncRead\(\)](#) to make an asynchronous AutoDMA acquisition:

```
// Configure the board to make an AutoDMA acquisition
AlazarBeforeAsyncRead(
    handle, // HANDLE -- board handle
    channelMask, // U32 -- enabled channel mask
    -(long)preTriggerSamples, // long -- trigger offset
    samplesPerBuffer, // U32 -- samples per buffer
    recordsPerBuffer, // U32 -- records per buffer
    recordsPerAcquisition, // U32 -- records per acquisition
    admaFlags // U32 -- AutoDMA flags
);

// Add two or more buffers to a list of buffers
// available to be filled by the board
for (i = 0; i < BUFFER_COUNT; i++) {
    AlazarAsyncRead (
        handle, // HANDLE -- board handle
        IoBufferArray[i].buffer, // void* -- buffer
        IoBufferArray[i].bytesPerBuffer, // U32 -- buffer length
        &IoBufferArray[i].overlapped // OVERLAPPED*
    );
}

// Arm the board to begin the acquisition
AlazarStartCapture(handle);

// Wait for each buffer in the acquisition to be filled.
U32 buffersCompleted = 0;
while (buffersCompleted < buffersPerAcquisition)
{
    // Wait for the board to receives sufficient
    // trigger events to fill the buffer at the head of its
    // list of available buffers.
    // The event handle will be set to the signaled state when
    // the buffer is full.
    U32 bufferIndex = buffersCompleted % BUFFER_COUNT;
    IO_BUFFER *pIoBuffer = IoBufferArray[bufferIndex];
```

(continues on next page)

(continued from previous page)

```
WaitForSingleObject(pIoBuffer->hEvent, INFINITE);
buffersCompleted++;

// The buffer is full, process it
// Note that while the application processes this buffer,
// the board is filling the next available buffer
// as trigger events arrive.
ProcessBuffer(pIoBuffer->buffer, pIoBuffer->bytesPerBuffer);

// Add the buffer to the end of the list of buffers.
// The board will fill it with another segment from the
// acquisition after the buffers preceding it have been filled.
AlazarAsyncRead (
handle, // HANDLE -- board handle
pIoBuffer->buffer, // void* -- buffer
pIoBuffer->bytesPerBuffer, // U32 -- buffer length
&pIoBuffer->overlapped // OVERLAPPED*
);
}

// Stop the acquisition. This function must be called if unfilled buffers are
// pending.
AlazarAbortAsyncRead(handle);
```

See “%ATS_SDK_DIR%\Samples\DualPort\CS_AsyncRead” for a full sample program that demonstrates make an AutoDMA acquisition using [AlazarAsyncRead\(\)](#).

AlazarAbortAsyncRead

The asynchronous API driver locks application buffers into memory so that boards may DMA directly into them. When a buffer is completed, the driver unlocks it from memory. An application must call [AlazarAbortAsyncRead\(\)](#) if, at the end of an acquisition, any of the buffers that it supplies to a board have not been completed. [AlazarAbortAsyncRead\(\)](#) completes any pending buffers, and unlocks them from memory.

Warning: If an application exits without calling [AlazarAbortAsyncRead\(\)](#), the API driver may generate a DRIVER_LEFT_LOCKED_PAGES_IN_PROCESS (0x000000CB) bug check error under Windows, or leak the locked memory under Linux. This may happen, for example, if a programmer runs an application that uses the API under a debugger, stops at a breakpoint, and then stops the debugging session without letting the application or API exit normally.

Buffer count

An application should supply at least two buffers to a board. This allows the board to fill one buffer while the application consumes the other. As long as the application can consume buffers faster than the board can fill them, the acquisition can continue indefinitely. However, Microsoft Windows and general-purpose Linux distributions are not real time operating systems. An application thread may be suspended for an indeterminate amount of time to allow other threads with higher priority to run. As a result, buffer processing may take longer than expected. The board is filling AutoDMA buffers with sample data in real time. If an application is unable to supply buffers as fast a board fills them, the board will run out of buffers into which it can transfer sample data. The board can continue to acquire data until it fills is on-board memory, but then it will abort the acquisition and report a buffer overflow error.

It is recommended that an application supply three or more buffers to a board. This allows some tolerance for operating system latencies. The programmer may need to increase the number of buffers according to the application.

Note: The number of buffers required by a board is not the same as the number of buffers required by an application. There may be little benefit in supplying a board with more than a few tens of buffers, each of a few million samples. If an application requires much more sample data for data analysis or other purposes, the programmer should consider managing application buffers separately from AutoDMA buffers.

Scanning applications

Scanning applications divide an acquisition into frames, where each frame is composed of a number of scan lines, and each scan line is composed of a number of sample points. These applications typically:

- Wait for a “start of frame” event.
- Wait for a number of “start of line” events, capturing a specified number of sample points after each “start of line” event.
- Wait for the next “start of frame” event and repeat.

To implement a scanning application using a hardware “start of frame” signal:

- Connect a TTL signal that will serve as the “start of frame” event to the AUX I/O connector.
- Call `AlazarConfigureAuxIO()` specifying `AUX_IN_TRIGGER_ENABLE` as the mode, and the active edge of the trigger enable signal as the parameter.
- Configure the board to make an `NPT()` or `Traditional()` mode AutoDMA acquisition where the number of “records per buffer” is equal to the number of scan lines per frame.
- Call `AlazarStartCapture()` to begin the acquisition.

- Supply a TTL pulse to the AUX I/O connector (or call `AlazarForceTriggerEnable()`) to arm the board to capture one frame. The board will wait for sufficient trigger events to capture the number of records in an AutoDMA buffer, and then wait for the next trigger enable event.

To implement a scanning application using a software “start of frame” command:

- Call `AlazarConfigureAuxIO()` specifying `AUX_OUT_TRIGGER_ENABLE` as the mode, along with the signal to output on the AUX I/O connector.
- Configure the board to make an `NPT()` or `Traditional()` mode AutoDMA acquisition where the number of “records per buffer” is equal to the number of scan lines per frame.
- Call `AlazarStartCapture()` to begin the acquisition.
- Call `AlazarForceTriggerEnable()` to arm the board to capture one frame. The board will wait for sufficient trigger events to capture the number of records in an AutoDMA buffer, and then wait for the next trigger enable event.

Note that if the number of records per acquisition is set to infinite, software arms the digitizer once to make an AutoDMA acquisition with an infinite number of frames. The hardware will continue acquiring frame data until the acquisition is aborted. See “%ATS_SDK_DIR%\Samples\DualPort\NPT_Scan” for sample programs that demonstrate how to make a scanning application using hardware trigger enable signals.

Other scanning applications (NPT Footers)

In some other applications, an acquisition is divided several frames, but the number of records per frame is not constant. This happens in imaging applications such as intravascular OCT. The rotation speed of the imaging probe is not constant and the number of records (A-lines) may vary from one frame to the other.

For this situation, the AUX I/O connector should not be used as a trigger enable input as in conventional scanning application. Instead, it can be used a frame counter. The frame number can be appended to each data record so the user can recover the frame number for each record and then reconstruct each frame correctly. These are called footers and can only be used in NPT acquisition mode. See the NPT footers section for more details about using NPT footers.

Master-slave applications

If a dual-port acquisition API is used to acquire from master-slave board system:

- Call `AlazarBeforeAsyncRead()` on all slave boards before the master board.
- Call `AlazarStartCapture()` only on the master board.
- Call `AlazarAbortAsyncRead()` on the master board before the slave boards.

- The board system acquires the boards in the board system in parallel. As a result, an application must consume a buffer from each board in the board system during each cycle of the acquisition loop.
- Do not use synchronous API functions with master-slave systems – use the asynchronous API functions instead.

The following sample programs demonstrate how to acquire from a master-slave system: “%ATS_SDK_DIR%\Samples\DualPort\TR_MS”, “%ATS_SDK_DIR%\Samples\DualPort\NPT_MS”, “%ATS_SDK_DIR%\Samples\DualPort\CS_MS”, and “%ATS_SDK_DIR%\Samples\DualPort\TS_MS”.

Buffer size and alignment

AlazarTech digitizer boards must be configured to acquire a minimum number of samples per record, and each record must be a multiple of a specified number of samples. Records may shift within a buffer if alignment requirements are not met. Please refer to [Samples per record requirements](#) for a list of requirements.

The number of pre-trigger samples in single-port and dual-port “traditional” AutoDMA mode must be a multiple of the pre-trigger alignment value above. See [AlazarSetRecordCount\(\)](#) and [AlazarSetRecordSize\(\)](#) for more information.

The address of application buffers passed to the following data transfer functions must meet the buffer alignment requirement in [Samples per record requirements](#): [AlazarRead\(\)](#), [AlazarReadEx\(\)](#), [AlazarAsyncRead\(\)](#), [AlazarPostAsyncBuffer\(\)](#), and [AlazarWaitAsyncBufferComplete\(\)](#). For example, the address of a buffer passed to [AlazarPostAsyncBuffer\(\)](#) to receive data from an ATS9350 must be aligned to a 32-sample, or 64-byte, address.

Note that [AlazarWaitNextAsyncBufferComplete\(\)](#) has no alignment requirements. As a result, an application can use this function to transfer data if it is impossible to allocate correctly aligned buffers.

Data format

By default, AlazarTech digitizers generate unsigned sample data. For example, 8-bit digitizers such as the ATS9870 generate sample codes between 0 and 255 (0xFF) where: 0 represents a negative full-scale input voltage, 128 (0x80) represents ~0V input voltage, 255 (0xFF) represents a positive full-scale input voltage. Some AlazarTech digitizer can be configured to generate signed sample data in two’s complement format. For example, the ATS9870 can be configured to generate sample codes where: 0 represents ~0V input voltage, 127 (0x7F) represents a positive full-scale input voltage, and -128 (0x80) represents a negative full-scale input voltage.

Call [AlazarSetParameter\(\)](#) with parameter SET_DATA_FORMAT before the start of an acquisition to set the sample data format, and call [AlazarGetParameter\(\)](#) with GET_DATA_FORMAT to get the current data format. The following code fragment demonstrates how to select signed sample data output:

```

AlazarSetParameter(
    handle, // HANDLE -- board handle
    0, // U8 -- channel Id (not used)
    SET_DATA_FORMAT, // U32 -- parameter to set
    DATA_FORMAT_SIGNED // long -- value (0 = unsigned, 1 = signed)
);

```

3.4.2 Single port acquisition

The single-port acquisition API allows an application to capture records to on-board memory – one per trigger event – and transfer records from on-board to host memory. Data acquisition and data transfer are made serially, so trigger events may be missed if they occur during data transfers.

Note: The single port acquisition mode is not recommended for new designs. It should only be used with PCI bus digitizers that are not capable of making dual-port acquisitions: ATS460 and ATS860 without dual-port memory upgrade, ATS310, ATS330, ATS850.

Acquiring to on-board memory

All channels mode

By default, AlazarTech digitizer boards share on-board memory equally between both of a board's input channels. A single-port acquisition in dual-channel mode captures samples from both input channels simultaneously to on-board memory and, after the acquisition is complete, allows samples from either input channel to be transferred from on-board memory to an application buffer. To program a board acquire to on-board memory in dual-channel mode:

1. Call [AlazarSetRecordSize\(\)](#) to set the number of samples per record, where a record may contain samples before and after its trigger event.
2. Call [AlazarSetRecordCount\(\)](#) to set the number records per acquisition – the board captures one record per trigger event.
3. Call [AlazarStartCapture\(\)](#) to arm the board to wait for trigger events.
4. Call [AlazarBusy\(\)](#) in a loop to poll until the board has received all trigger events in the acquisition, and has captured all records to on-board memory.
5. Call [AlazarRead\(\)](#), [AlazarReadEx\(\)](#), or [AlazarHyperDisp\(\)](#) to transfer records from on-board memory to host memory.
6. Repeat from step 3, if necessary.

The following code fragment acquires to on board memory with on-board memory shared between both input channels:

```
// 1. Set record size
AlazarSetRecordSize (
    boardHandle, // HANDLE -- board handle
    preTriggerSamples, // U32 -- pre-trigger samples
    postTriggerSamples // U32 -- post-trigger samples
);

// 2. Set record count
AlazarSetRecordCount(
    boardHandle, // HANDLE -- board handle
    recordsPerCapture // U32 -- records per acquisition
);

// 3. Arm the board to wait for trigger events
AlazarStartCapture(boardHandle);

// 4. Wait for the board to receive all trigger events and capture all
//     records to on-board memory

while (AlazarBusy (boardHandle))
{
    // The acquisition is in progress
}

// 5. The acquisition is complete. Call AlazarRead or AlazarHyperDisp to
//     transfer records from on-board memory to your buffer.
```

Single channel mode

Note: The single port acquisition mode is not recommended for new designs. It should only be used with digitizers that are not capable of making dual-port acquisitions: ATS310, ATS330 and ATS850.

ATS9325, ATS9350, ATS9351, ATS9440, ATS9625, ATS9626, ATS9850, and ATS9870 and digitizer boards can be configured to dedicate all on-board memory to one of a board's input channels. A single-port acquisition in single-channel mode only captures samples from the specified channel to on-board memory and, after the acquisition is complete, only allows samples from the specified channel to be transferred from on-board memory to an application buffer.

To program a board to acquire to on-board memory in single-channel mode:

1. Call `AlazarSetRecordSize()` to set the number of samples per record, where a record may contain samples before and after its trigger event.
2. Call `AlazarSetRecordCount()` to set the number records per acquisition – the board captures one record per trigger event.
3. Call `AlazarSetParameter()` with the parameter `SET_SINGLE_CHANNEL_MODE`, and specify the

channel to use all memory.

4. Call `AlazarStartCapture()` to arm the board to wait for trigger events.
5. Call `AlazarBusy()` in a loop to poll until the board has received all trigger events in the acquisition, and has captured all records to on-board memory.
6. Call `AlazarRead()`, `AlazarReadEx()`, or `AlazarHyperDisp()` to transfer records from on-board memory to host memory.
7. Repeat from step 3, if necessary.

The following code fragment acquires to on-board memory from CH A in single channel mode:

```
// 1. Set record size
AlazarSetRecordSize (
    boardHandle, // HANDLE -- board handle
    preTriggerSamples, // U32 -- pre-trigger samples
    postTriggerSamples // U32 -- post-trigger samples
);

// 2. Set record count
AlazarSetRecordCount(
    boardHandle, // HANDLE -- board handle
    recordsPerCapture // U32 -- records per acquisition
);

// 3. Enable single channel mode
AlazarSetParameter(
    boardHandle, // HANDLE -- board handle
    0, // U8 -- channel Id (not used)
    SET_SINGLE_CHANNEL_MODE, // U32 -- parameter
    CHANNEL_A // long CHANNEL_A or CHANNEL_B
);

// 4. Arm the board to wait for trigger events
AlazarStartCapture(boardHandle);

// 5. Wait for the board to receive all trigger events
// and capture all records to on-board memory
while (AlazarBusy (boardHandle))
{
    // The acquisition is in progress
}

// 6. The acquisition is complete. Call AlazarRead or
// AlazarHyperDisp to transfer records from on-board memory
// to your buffer.
```

Note: A call to `AlazarSetParameter()` must be made before each call to `AlazarStartCapture()`.

If the of number of samples per record specified in `AlazarSetRecordSize()` is greater than the maximum number of samples per channel in dual-channel mode, but is less than the maximum number of samples per record in single-channel mode, and `AlazarSetParameter()` is not called before calling `AlazarStartCapture()`, then `AlazarStartCapture()` will fail with error `ApiNotSupportedInDualChannelMode`.

Using AlazarRead

Use `AlazarRead()` to transfer samples from records acquired to on-board memory to a buffer in host memory.

Transferring full records

The following code fragment transfers a full CH A record from on-board memory to a buffer in host memory:

```
// Allocate a buffer to hold one record.
// Note that the buffer must be at least 16 samples
// larger than the number of samples per record.
U32 allocBytes = bytesPerSample * (samplesPerRecord + 16);
void* buffer = malloc(allocBytes);

// Transfer a CHA record into our buffer
AlazarRead (
    boardHandle, // HANDLE -- board handle
    CHANNEL_A, // U32 -- channel Id
    buffer, // void* -- buffer
    bytesPerSample, // int -- bytes per sample
    (long) record, // long -- record (1 indexed)
    -((long)preTriggerSamples), // long -- trigger offset
    samplesPerRecord // U32 -- samples to transfer
);
```

See “%ATS_SDK_DIR%\Samples\SinglePort\AR” for a complete sample program that demonstrates how to use `AlazarRead()` to read full records.

Transferring partial records

`AlazarRead()` can transfer a segment of a record from on-board memory to a buffer in host memory. This may be useful if:

- The number of bytes in a full record in on-board memory exceeds the buffer size in bytes that an application can allocate in host memory.
- An application wishes to reduce the time required for data transfer when it acquires relatively long records to on-board memory, but is only interested in a relatively small part of the record.

Use the `transferOffset` parameter in the call to `AlazarRead()` to specify the offset, in samples from the trigger position in the record, of the first sample to transfer from on-board memory to the application buffer. And use the `transferLength` parameter to specify the number of samples to transfer from on-board memory to the application buffer, where this number of samples may be less than the number of samples per record. The following code fragment divides a record into segments, and transfers the segments from on-board to host memory:

```
// Allocate a buffer to hold one record segment.
// Note that the buffer must be at least 16 samples
// larger than the number of samples per buffer.
U32 allocBytes = bytesPerSample * (samplesPerBuffer + 16);
void* buffer = malloc(allocBytes);

// Transfer a record in segments from on-board memory
U32 samplesToRead = samplesPerRecord;
long triggerOffset_samples = -(long)preTriggerSamples;
while (samplesToRead > 0) {
    // Transfer a record segment from on-board memory
    U32 samplesThisRead;
    if (samplesToRead > samplesPerBuffer)
        samplesThisRead = samplesPerBuffer;
    else
        samplesThisRead = samplesToRead;
    AlazarRead (
        boardHandle, // HANDLE -- board handle
        CHANNEL_A, // U32 -- channel Id
        buffer, // void* -- buffer
        bytesPerSample, // int -- bytes per sample
        (long) record, // long -- record (1 indexed)
        triggerOffset_samples, // long -- trigger offset
        samplesThisRead // U32 -- samples to transfer
    );

    // Process the record segment here
    WriteSamplesToFile(buffer, samplesThisRead);

    // Point to next record segment in on-board memory
    triggerOffset_samples += samplesThisRead;

    // Decrement number of samples left to read
    samplesToRead -= samplesThisRead;
}
```

See “%ATS_SDK_DIR%\Samples\SinglePort\AR_Segments” for a complete sample program that demonstrates how to read records in segments.

Using AlazarReadEx

`AlazarRead()` can transfer samples from records acquired to on-board memory that contain up to 2,147,483,647 samples. If a record contains 2,147,483,648 or more samples, use `AlazarReadEx()` rather than `AlazarRead()`. `AlazarReadEx()` uses signed 64-bit transfer offsets, while `AlazarRead()` uses signed 32-bit transfer offsets. Otherwise, `AlazarReadEx()` and `AlazarRead()` are identical.

Using AlazarHyperDisp

HyperDisp technology enables the FPGA on an AlazarTech digitizer board to process sample data. The FPGA divides a record in on-board memory into intervals, finds the minimum and maximum sample values during each interval, and transfers an array of minimum and maximum value pairs to host memory. This allows the acquisition of relatively long records to on-board memory, but the transfer of relatively short processed records across the PCI/PCIe bus to host memory.

For example, an ATS860-256M would require over 2 seconds per channel to transfer 256,000,000 samples across the PCI bus. However, with HyperDisp enabled the ATS860 would require a fraction of a second to calculate HyperDisp data, and transfer a few kilobytes of processed data across the PCI bus. If an application was searching these records for glitches, it may save a considerable amount of time by searching HyperDisp data for the glitches and, if a glitch were found, transfer the raw sample data from the interval from on-board memory to host memory.

Use `AlazarHyperDisp()` to enable a board to process records in on-board memory, and transfer processed records to host memory. The following code fragment enables an ATS860-256M to process a record in on-board memory containing 250,000,000 samples into an array of 100 HyperDisp points, where each point contains the minimum and maximum sample values over an interval of 2,500,000 samples in the record:

```
// Specify number of samples per record
U32 preTriggerSamples = 125000000;
U32 postTriggerSamples = 125000000;
U32 samplesPerRecord = preTriggerSamples + postTriggerSamples;
U32 recordsPerCapture = 1;

// Acquire to on-board memory (omitted)
// Specify the number of HyperDisp points
U32 pointsPerRecord = 100;

// Allocate a buffer to store the HyperDisp data
U32 bytesPerSample = 1; // ATS860 constant
U32 samplesPerPoint = 2; // HyperDisp constant
U32 bytesPerBuffer = bytesPerSample * samplesPerPoint * pointsPerRecord;
U8 *buffer = (U8*) malloc(bytesPerBuffer);

// Enable ATS860 FPGA to process the 250M sample record
// in on-board memory into an array of 100 HyperDisp points,
```

(continues on next page)

(continued from previous page)

```
// and transfer the HyperDisp points into our buffer
U32 error;

AlazarHyperDisp (
    boardHandle, // HANDLE -- board handle
    NULL, // void* -- reserved
    samplesPerRecord, // U32 -- BufferSize
    (U8*) buffer, // U8* -- ViewBuffer
    bytesPerBuffer, // U32 -- ViewBufferSize
    pointsPerRecord, // U32 -- NumOfPixels
    1, // U32 -- Option (1 = HyperDisp)
    CHANNEL_A, // U32 -- ChannelSelect
    1, // U32 -- record (1 indexed)
    -(long)preTriggerSamples, // long -- TransferOffset
    &error // U32* -- error
);
```

See “%ATS_SDK_DIR%\Samples\SinglePort\HD” for a complete sample program that demonstrates how to use [AlazarHyperDisp\(\)](#).

Record timestamps

AlazarTech digitizer boards include a 40-bit counter clocked by the sample clock source scaled by a board specific divider. When a board receives a trigger event to capture a record to on-board memory, it latches and saves the value of this counter. The counter value gives the time, relative to when the counter was reset, when the trigger event for the record occurred.

By default, this counter is reset to zero at the start of each acquisition. Use [AlazarResetTimeStamp\(\)](#) to control when the record timestamp counter is reset.

Use [AlazarGetTriggerAddress\(\)](#) to retrieve the timestamp, in timestamp clock ticks, of a record acquired to on-board memory. This function does not convert the timestamp value to seconds. The following code fragment gets the record timestamp of a record acquired to on-board memory, and converts the timestamp value from clocks ticks to seconds:

```
// Read the record timestamp
U32 triggerAddress;
U32 timestampHigh;
U32 timestampLow;

AlazarGetTriggerAddress (
    boardHandle, // HANDLE -- board handle
    record, // U32 -- record number (1-indexed)
    &triggerAddress, // U32* -- trigger address
    &timestampHigh, // U32* -- timestamp high part
    &timestampLow // U32* -- timestamp low part
);
```

(continues on next page)

(continued from previous page)

```
// Convert the record timestamp from counts to seconds
__int64 timeStamp_cnt;
timeStamp_cnt = ((__int64) timestampHigh) << 8;
timeStamp_cnt |= timestampLow & 0x0fff;
double samplesPerTimestampCount = 2; // board specific constant
double samplesPerSec = 50.e6; // sample rate
double timeStamp_sec = (double) samplesPerTimestampCount *
                       timeStamp_cnt / samplesPerSec;
```

Call `AlazarGetParameter()` with the `GET_SAMPLES_PER_TIMESTAMP_CLOCK` parameter to obtain the board specific “samples per timestamp count” value. See [Samples per record requirements](#) for a list of these values. See “%ATS_SDK_DIR%\Samples\SinglePort\AR_Timestamps” for a complete sample program that demonstrates how to retrieve record timestamps and convert them to seconds.

Master-slave applications

If the single-port API is used to acquire from master-slave board system, only the master board in the board system should receive calls to the following API functions: `AlazarStartCapture()`, `AlazarAbortCapture()`, `AlazarBusy()`, `AlazarTriggered()` and `AlazarForceTrigger()`. See “%ATS_SDK_DIR%\Samples\SinglePort\AR_MasterSlave” for a sample program that demonstrates how to acquire from a master-slave system.

3.5 Processing data

3.5.1 Converting sample values to volts

The data acquisition APIs transfer an array of sample values into an application buffer. Each sample value occupies 1 or 2 bytes in the buffer, where a sample code is stored in the most significant bits of the sample values. Sample values that occupy two bytes are stored with their least significant bytes at the lower byte addresses (little-endian byte order) in the buffer. To convert sample values in the buffer to volts:

- Get a sample value from the buffer.
- Get the sample code from the most-significant bits of the sample value.
- Convert the sample code to volts.

Note that the arrangement of samples values in the buffer into records and channels depends on the API used to acquire the data.

- Single-port acquisitions return a contiguous array of samples for a specified channel. (See [Single Port Acquisition](#) above.)
- Dual-port AutoDMA acquisitions return sample data whose arrangement depends on the AutoDMA mode and options chosen. (See section [Dual port AutoDMA Acquisition](#) above.)

Also note that AlazarTech digitizer boards generate unsigned sample codes by default. (See [Data format](#) above.)

8-bits per sample

Getting 1-byte sample values from the buffer

The hexadecimal editor view below shows the first 128-bytes of data in a buffer from an 8-bit digitizer such as the ATS850, ATS860, ATS9850, and ATS9870.

```
00000 7F 7F 7F 7F 7F 7F 7F 7F 7F 7F 7F 7F 7F 7F 7F
00010 7F 7F 7F 7F 7F 7F 7F 7F 7F 7F 7F 7F 7F 7F
00020 7F 7F 7F 7F 7F 7F 7F 7F 7F 7F 7F 7F 7F 7F
00030 7F 7F 7F 7F 7F 7F 7F 7F 7F 7F 7F 7F 7F 7F
00040 7F 7F 7F 7F 7F 7F 7F 7F 7F 7F 7F 7F 7F 7F
00050 7F 7F 7F 7F 7F 7F 7F 7F 7F 7F 7F 7F 7F 7F
00060 7F 7F 7F 7F 7F 7F 7F 7F 7F 7F 7F 7F 7F 7F
00070 7F 7F 7F 7F 7F 7F 7F 7F 7F 7F 7F 7F 7F 7F
```

Each 8-bit sample occupies 1-byte in the buffer, so the block above displays 128 samples (128 bytes / 1 byte per sample). The following code fragment demonstrates how to access each 8-bit sample value in a buffer:

```
U8 *pSamples = (U8*) buffer;
for (U32 sample = 0; sample < samplesPerBuffer; sample++) {
    U8 sampleValue = *pSamples++;
    printf("sample value = %02Xn", sampleValue);
}
```

Getting 8-bit sample codes from 1-byte sample values

Each 8-bit sample value stores an 8-bit sample code. For example, the first byte in buffer above stores the sample code 0x7F, or 127 decimal.

Converting unsigned 8-bit sample codes to volts

A sample code of 128 (0x80) represents ~0V input voltage, 255 (0xFF) represents a positive full-scale input voltage, and 0 represents a negative full-scale input voltage. The following table illustrates how unsigned 8-bit sample codes map to values in volts according to the full-scale input range of the input channel.

Hex value	Fraction of input range	Volts for ±100 mV range	Volts for ±1 V range
0x00	-100%	-100 mV	-1 V
0x40	-50%	-50 mV	-.5 V
0x80	0%	0 V	0V
0xC0	+50%	50 mV	+.5 V
0xFF	+100%	+100 mV	+1 V

The following code fragment shows how to convert a 1-byte sample value containing an unsigned 8-bit code to in volts:

```
double SampleToVoltsU8(U8 sampleValue, double inputRange_volts)
{
    // AlazarTech digitizers are calibrated as follows

    double codeZero = (double)UCHAR_MAX/2;
    double codeRange = (double)UCHAR_MAX/2;
    // Convert sample code to volts
    double sampleVolts = inputRange_volts *
        ((double) (sampleValue - codeZero) / codeRange);
    return sampleVolts;
}
```

Converting signed 8-bit sample codes to volts

A signed code of 0 represents ~0V input voltage, 127 (0x7F) represents a positive full-scale input voltage, and -128 (0x80) represents a negative full-scale input voltage. The following table illustrates how signed 8-bit sample codes map to values in volts according to the full-scale input range of the input channel.

Hex value	Fraction of input range	Volts for ±100 mV range	Volts for ±1 V range
0x81	-100%	-100 mV	-1 V
0xC0	-50%	-50 mV	-.5 V
0x00	0%	0 V	0V
0x40	+50%	50 mV	+.5 V
0x7F	+100%	+100 mV	+1 V

The following code fragment shows how to convert a 1-byte sample value containing a signed 8-bit sample code to in volts:

```
double SampleToVoltsS8(S8 sampleValue, double inputRange_volts)
{
    // AlazarTech digitizers are calibrated as follows
    double codeZero = 0;
    double codeRange = (double)SCHAR_MAX;
    // Convert sample code to volts
```

(continues on next page)

(continued from previous page)

```

double sampleVolts = inputRange_volts *
  ((double) (sampleCode - codeZero) / codeRange);
return sampleVolts;
}

```

12-bits per sample

Getting 2-byte sample values from the buffer

The hexadecimal editor view below displays the first 128-bytes of data in a buffer from a 12-bit digitizer such as the ATS310, ATS330, ATS9325, ATS9350, ATS9351, ATS9352, ATS9353, ATS9360, ATS9371, and ATS9373.

```

00000  E0 7F F0 7F 00 80 F0 7F  F0 7F 10 80 E0 7F 00 80
00010  F0 7F 00 80 E0 7F E0 7F  00 80 E0 7F F0 7F F0 7F
00020  E0 7F F0 7F 00 80 F0 7F  F0 7F 10 80 E0 7F 00 80
00030  F0 7F 00 80 E0 7F E0 7F  00 80 E0 7F F0 7F F0 7F
00040  E0 7F F0 7F 00 80 F0 7F  F0 7F 10 80 E0 7F 00 80
00050  F0 7F 00 80 E0 7F E0 7F  00 80 E0 7F F0 7F F0 7F
00060  E0 7F F0 7F 00 80 F0 7F  F0 7F 10 80 E0 7F 00 80
00070  F0 7F 00 80 E0 7F E0 7F  00 80 E0 7F F0 7F F0 7F

```

Each 12-bit sample value occupies a 2-bytes in the buffer, so the view above displays 64 sample values (128 bytes / 2 bytes per sample). The first 2 bytes in the buffer are 0xE0 and 0x7F. Two-byte sample values are stored in little-endian byte order in the buffer, so the first sample value in the buffer is 0x7FE0. The following code fragment demonstrates how to access each 16-bit sample value in a buffer:

```

U16 *pSamples = (U16*)buffer;
for (U32 sample = 0; sample < samplesPerBuffer; sample++) {
    U16 sampleValue = *pSamples++;
    printf("sample value = %04X\n", sampleValue);
}

```

Getting 12-bit sample codes from 16-bit sample values

A 12-bit sample code is stored in the most significant bits (MSB) of each 16-bit sample value, so right-shift each 16-bit value by 4 (or divide by 16) to obtain the 12-bit sample code. In the example above, the 16-bit sample value 0x7FE0 right-shifted by four results in the 12-bit sample code 0x7FE, or 2046 decimal.

16-bit sample value in decimal	32736
16-bit sample value in hex	7FE0
16-bit sample value in binary	0111 1111 1110 0000
12-bit sample code from MSBs of 16-bit value	0111 1101 1110
12-bit sample code in hex	7FE
12-bit sample code in decimal	2046

Converting unsigned 12-bit sample codes to volts

An unsigned code of 2048 (0x800) represents ~0V input voltage, 4095 (0xFFFF) represents a positive full-scale input voltage, and 0 represents a negative full-scale input voltage. The following table illustrates how unsigned 12-bit sample codes map to values in volts according to the full-scale input range of the input channel.

Hex value	Fraction of input range	Volts for ±100 mV range	Volts for ±1 V range
0x000	-100%	-100 mV	-1 V
0x400	-50%	-50 mV	-.5 V
0x800	0%	0 V	0V
0xC00	+50%	50 mV	+.5 V
0xFFFF	+100%	+100 mV	+1 V

The following code fragment demonstrates how to convert a 2-byte word containing an unsigned 12-bit sample code to in volts:

```
double SampleToVoltsU12(U16 sampleValue, double inputRange_volts)
{
    // Right-shift 16-bit sample word by 4 to get 12-bit sample code
    int bitShift = 4;
    U16 sampleCode = sampleValue >> bitShift;
    // AlazarTech digitizers are calibrated as follows
    int bitsPerSample = 12;
    double codeZero = (1 << (bitsPerSample - 1)) - 0.5;
    double codeRange = (1 << (bitsPerSample - 1)) - 0.5;
    // Convert sample code to volts
    double sampleVolts = inputRange_volts *
        ((double) (sampleCode - codeZero) / codeRange);
    return sampleVolts;
}
```

Converting signed 12-bit sample codes to volts

A signed code of 0 represents ~0V input voltage, 2047 (0x7FF) represents a positive full-scale input voltage, and -2048 (0x801) represents a negative full-scale input voltage. The following table illustrates how signed 12-bit sample codes map to values in volts according to the full-scale input range of the input channel.

Hex value	Fraction of input range	Volts for ± 100 mV range	Volts for ± 1 V range
0x801	-100%	-100 mV	-1 V
0xC00	-50%	-50 mV	-.5 V
0x000	0%	0 V	0V
0x400	+50%	50 mV	+0.5 V
0x7FF	+100%	+100 mV	+1 V

The following code fragment shows how to convert a 2-byte sample word containing a signed 12-bit sample code to in volts:

```
double SampleToVoltsS12(S16 sampleValue, double inputRange_volts)
{
    // Right-shift 16-bit sample value by 4 to get 12-bit sample code
    int bitShift = 4;
    U16 sampleCode = sampleValue >> bitShift;
    // AlazarTech digitizers are calibrated as follows
    int bitsPerSample = 12;
    double codeZero = 0;
    double codeRange = (1 << (bitsPerSample - 1)) - 1;
    // Convert sample code to volts
    double sampleVolts = inputRange_volts *
        ((double) (sampleCode - codeZero) / codeRange);
    return sampleVolts;
}
```

14-bits per sample

Getting 2-byte sample values from the buffer

The hexadecimal editor view below displays the first 128-bytes of data in a buffer from a 14-bit digitizer such as the ATS460 and ATS9440.

```
00000 4C 7F EC 7f 3c 80 98 80   D0 80 24 81 7C 81 B4 81
00010 3C 82 B4 82 A8 82 60 83   9C 83 14 84 40 84 88 84
00020 E0 84 50 85 D0 85 FC 85   2C 86 B0 86 10 87 56 87
00030 4C 7F EC 7f 3c 80 98 80   D0 80 24 81 7C 81 B4 81
00040 3C 82 B4 82 A8 82 60 83   9C 83 14 84 40 84 88 84
00050 E0 84 50 85 D0 85 FC 85   2C 86 B0 86 10 87 56 87
00060 4C 7F EC 7f 3c 80 98 80   D0 80 24 81 7C 81 B4 81
00070 E0 84 50 85 D0 85 FC 85   2C 86 B0 86 10 87 56 87
```

Each sample value occupies a 2-bytes in the buffer, so the figure displays 64 sample values (128 bytes / 2 bytes per sample). The first 2 bytes in the buffer, shown highlighted, are 0x4C and 0x7F. Two-byte sample values are stored in little-endian byte order in the buffer, so the first sample value in the buffer is 0x7F4C. The following code fragment demonstrates how to access each 16-bit sample value in a buffer:

```
U16 *pSamples = (U16*) buffer;
for (U32 sample = 0; sample < samplesPerBuffer; sample++) {
    U16 sampleValue = *pSamples++;
    printf("sample value = %04X\n", sampleValue);
}
```

Getting 14-bit sample codes from 16-bit sample values

A 14-bit sample code is stored in the most significant bits of each 16-bit sample value in the buffer, so right-shift each 16-bit value by 2 (or divide by 4) to obtain the 14-bit sample code. In the example above, the 16-bit value 0x7F4C right-shifted by two results in the 14-bit sample code 0x1FD3, or 8147 decimal.

16-bit sample value in decimal	32588
16-bit sample value in hex	7F4C
16-bit sample value in binary	0111 1111 0100 1100
14-bit sample code from MSBs of 16-bit sample value	01 1111 1101 0011
14-bit sample code in hex	1FD3
14-bit sample code in decimal	8147

Converting unsigned 14-bit sample codes to volts

An unsigned code of 8192 (0x2000) represents ~0V input voltage, 16383 (0x3FFF) represents a positive full-scale input voltage, and 0 represents a negative full-scale input voltage. The following table illustrates how unsigned 14-bit sample codes map to values in volts according to the full-scale input range of an input channel.

Hex value	Fraction of input range	Volts for ±100 mV range	Volts for ±1 V range
0x0000	-100%	-100 mV	-1 V
0x1000	-50%	-50 mV	-.5 V
0x2000	0%	0 V	0V
0x3000	+50%	50 mV	+.5 V
0x3FFF	+100%	+100 mV	+1 V

The following code fragment demonstrates how to convert a 2-byte sample value containing an unsigned 14-bit sample code to in volts:

```
double SampleToVoltsU14(U16 sampleValue, double inputRange_volts)
{
    // Right-shift 16-bit sample word by 2 to get 14-bit sample code
    int bitShift = 2;
    U16 sampleCode = sampleValue >> bitShift;
    // AlazarTech digitizers are calibrated as follows
    int bitsPerSample = 14;
    double codeZero = (1 << (bitsPerSample - 1)) - 0.5;
    double codeRange = (1 << (bitsPerSample - 1)) - 0.5;
    // Convert sample code to volts
    double sampleVolts = inputRange_volts *
        ((double) (sampleCode - codeZero) / codeRange);
    return sampleVolts;
}
```

Converting signed 14-bit sample codes to volts

A signed code of 0 represents ~0V input voltage, 8191 (0x1FFF) represents a positive full-scale input voltage, and -8192 (0x2000) represents a negative full-scale input voltage. The following table illustrates how signed 14-bit sample codes map to values in volts depending on the full-scale input range of the input channel.

Hex value	Fraction of input range	Volts for ±100 mV range	Volts for ±1 V range
0x2001	-100%	-100 mV	-1 V
0x3000	-50%	-50 mV	-.5 V
0x0000	0%	0 V	0V
0x1000	+50%	50 mV	+5 V
0x1FFF	+100%	+100 mV	+1 V

The following code fragment demonstrates how to convert a 2-byte sample value containing a signed 14-bit sample code to in volts:

```
double SampleToVoltsS14(S16 sampleValue, double inputRange_volts)
{
    // Right-shift 16-bit sample word by 2 to get 14-bit sample code
    int bitShift = 2;
    U16 sampleCode = sampleValue >> bitShift;
    // AlazarTech digitizers are calibrated as follows
    int bitsPerSample = 14;
    double codeZero = 0;
    double codeRange = (1 << (bitsPerSample - 1)) - 1;
    // Convert sample code to volts
    double sampleVolts = inputRange_volts *
        ((double) (sampleCode - codeZero) / codeRange);
    return sampleVolts;
}
```

16-bit per sample

Getting 2-byte sample values from the buffer

The hexadecimal editor view below displays the first 128-bytes of data in a buffer from a 16-bit digitizer such as the ATS660, ATS9462, ATS9625, or ATS9626.

```
00000 14 80 FB 7F FB 7F 08 80 FB 7F 00 80 02 80 ED 7F
00010 0B 80 FF 7F F8 7F 0B 80 09 80 0E 80 F3 7F FE 7F
00020 14 80 FB 7F FB 7F 08 80 FB 7F 00 80 02 80 ED 7F
00030 0B 80 FF 7F F8 7F 0B 80 09 80 0E 80 F3 7F FE 7F
00040 14 80 FB 7F FB 7F 08 80 FB 7F 00 80 02 80 ED 7F
00050 0B 80 FF 7F F8 7F 0B 80 09 80 0E 80 F3 7F FE 7F
00060 14 80 FB 7F FB 7F 08 80 FB 7F 00 80 02 80 ED 7F
00070 14 80 FB 7F FB 7F 08 80 FB 7F 00 80 02 80 ED 7F
```

Each 16-bit sample value occupies 2 bytes in the buffer, so the figure displays 64 sample values (128 bytes / 2 bytes per sample). The first 2 bytes in the buffer are 0x14 and 0x80. Two-byte samples values are stored in little-endian byte order in the buffer, so the first sample value is 0x8014. The following code fragment demonstrates how to access each 16-bit sample value in a buffer:

```
U16 *pSamples = (U16*)buffer;
for (U32 sample = 0; sample < samplesPerBuffer; sample++)
{
    U16 sampleValue = * pSamples++;
    printf("sample value = %04X\n", sampleValue);
}
```

Getting 16-bit sample codes from 16-bit sample values

A 16-bit sample code is stored in each 16-bit sample value in the buffer. In the example above, the first sample code is 0x8014, or 32788 decimal.

Converting unsigned 16-bit sample codes to volts

An unsigned code of 32768 (0x8000) represents ~0V input voltage, 65535 (0xFFFF) represents a positive full-scale input voltage, and 0 represents a negative full-scale input voltage. The following table illustrates how unsigned 16-bit sample codes map to values in volts according to the full-scale input range of an input channel.

Hex value	Fraction of input range	Volts for ±100 mV range	Volts for ±1 V range
0x0000	-100%	-100 mV	-1 V
0x4000	-50%	-50 mV	-.5 V
0x8000	0%	0 V	0V
0xC000	+50%	50 mV	+.5 V
0xFFFF	+100%	+100 mV	+1 V

The following code fragment demonstrates how to convert a 2-byte sample value containing an unsigned 16-bit sample code to in volts:

```
double SampleToVoltsU16(U16 sampleValue, double inputRange_volts)
{
    // AlazarTech digitizers are calibrated as follows
    double codeZero = (double) USHRT_MAX/2;
    double codeRange = (double) USHRT_MAX/2;
    // Convert sample code to volts
    double sampleVolts = inputRange_volts *
        ((double) (sampleValue - codeZero) / codeRange);
    return sampleVolts;
}
```

Converting signed 16-bit sample codes to volts

A signed code of 32767 (0x7FFF) represents a positive full-scale input voltage, 0 represents ~0V input voltage, and -32768 (0x8000) represents a negative full-scale input voltage. The following table illustrates how signed 16-bit sample codes map to values in volts according to the full-scale input range of the input channel:

Hex value	Fraction of input range	Volts for ±100 mV range	Volts for ±1 V range
0x8001	-100%	-100 mV	-1 V
0xC000	-50%	-50 mV	-.5 V
0x0000	0%	0 V	0V
0x4000	+50%	50 mV	+.5 V
0x7FFF	+100%	+100 mV	+1 V

The following code fragment demonstrates how to convert a 2-byte sample word containing a signed 16-bit sample code to in volts:

```
double SampleToVoltsS16(S16 sampleValue, double inputRange_volts)
{
    // AlazarTech digitizers are calibrated as follows
    double codeZero = 0;
    double codeRange = SHRT_MAX;
    // Convert sample code to volts
    double sampleVolts = inputRange_volts *
```

(continues on next page)

(continued from previous page)

```
((double) (sampleCode - codeZero) / codeRange);  
return sampleVolts;  
}
```

3.5.2 Saving binary files

If an application saves sample data to a binary data file for later processing, it may be possible to improve disk write speeds by considering the following recommendations.

C/C++ applications

If the application is written in C/C++ and is running under Windows, use the Windows CreateFile API with the FILE_FLAG_NO_BUFFERING flag for file I/O, if possible. Sequential disk write speeds are often substantially higher when this option is selected. See “%ATS_SDK_DIR%\Samples\DualPort\TS_DisableFileCache” for a sample program that demonstrates how to use this API to stream data to disk.

LabVIEW applications

If the application is written in LabVIEW, or another high-level programming environment, then consider using the AlazarCreateStreamFile() API function. This function creates a binary data file, and enables the API to save each buffer received during an AutoDMA acquisition to this file. The API uses high-performance disk I/O functions that would be difficult to implement in high-level environments like LabVIEW. As a result, it allows an application in such an environment to perform high-performance disk streaming with a single additional function call. The following code fragment outlines how to write a disk streaming application using AlazarCreateStreamFile():

```
// Allow the API to allocate and manage AutoDMA buffers  
flags |= ADMA_ALLOC_BUFFERS;  
  
// Configure the board to make an AutoDMA acquisition  
AlazarBeforeAsyncRead(  
    handle, // HANDLE -- board handle  
    channelMask, // U32 -- enabled channel mask  
    -(long)preTriggerSamples, // long -- trigger offset  
    samplesPerRecord, // U32 -- samples per record  
    recordsPerBuffer, // U32 -- records per buffer  
    recordsPerAcquisition, // U32 -- records per acquisition  
    flags // U32 -- AutoDMA mode and options  
);  
  
// Create a binary data file, and enable the API save each  
// AutoDMA buffer to this file.  
AlazarCreateStreamFile(handle, "data.bin");
```

(continues on next page)

(continued from previous page)

```
// Arm the board to begin the acquisition
AlazarStartCapture(handle);

// Wait for each buffer in the acquisition to be filled
RETURN_CODE retCode = ApiSuccess;
while (retCode == ApiSuccess) {
    // Wait for the board to receive sufficient trigger
    // events to fill an internal buffer.
    // The API will save the buffer to a binary data file,
    // but will not copy any data into our buffer.
    retCode =
    AlazarWaitNextAsyncBufferComplete(
        handle, // HANDLE -- board handle
        NULL, // void* -- buffer to receive data
        0, // U32 -- bytes to copy into buffer
        timeout_ms // U32 -- time to wait for buffer
    );
}

// Abort the acquisition and release resources.
// This function must be called after an acquisition.
AlazarAbortAsyncRead(boardHandle);
```

See “%ATS_SDK_DIR%\Samples\DualPort\CS_CreateStreamFile” for a full sample program that demonstrates how to stream sample data to disk using `AlazarCreateStreamFile()`.

ALAZARDSP API DOCUMENTATION

This document presents the AlazarDSP API that allows accessing the on-board digital signal processing (DSP) features provided with some AlazarTech digitizers. Knowledge of the ATS-SDK API is required to take full advantage of the information presented here.

4.1 Introduction

4.1.1 On-FPGA FFT Overview

The first DSP module to make it into AlazarDSP is a Fast Fourier Transform (FFT) block implemented in ATS9350, ATS9351, ATS9352, ATS9353, ATS9360, ATS9364, ATS9370, ATS9371 and ATS9373. This is a very versatile module that allows its users to compute the Fourier Transform of the input signal acquired on channel A, and to retrieve the processed data in a variety of output formats. The acquired records can be padded then multiplied with a complex window function before going in the FFT processing block. The resulting data can optionally be scaled to get its logarithm. The nature of the output data can be chosen (amplitude, real, imaginary), and it is then possible to set the output format from a variety of combinations (floating point, 32-bit unsigned integer, etc.). Lastly, it is possible to get at the output either FFT data, raw (time domain) data or both. The following diagram is a high-level overview of the FFT processing module.

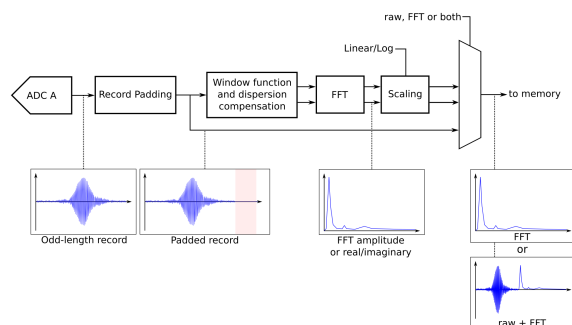

4.1.2 General Programming Concepts

All the functions from the AlazarDSP module are defined in `AlazarDSP.h`, and are implemented in the usual `ATSApi` library (`ATSApi.dll` under Windows, and `libATSApi.so` under Linux).

Function are prefixed either with `AlazarDSP` if they apply to any DSP block, or by `AlazarFFT` if they are specific to fast Fourier transform modules.

The AlazarDSP API introduces a new type called `dsp_module_handle`, which represents a DSP module within a digitizer. Depending on their scope, function calls either require a board or a DSP module handle to be passed.

Note: The AlazarDSP functions *must* be used in the context of AutoDMA NPT applications.

4.1.3 Transition From Time-Domain Acquisitions

This section details all the steps that are required to take a working AutoDMA NPT program and turn it into a FFT program. These code samples can be found in AlazarTech's [ATS-SDK](#)

Function calls to the AlazarTech API are usually split into two categories: board configuration and data acquisition. This is best seen in the code samples provided with the ATS-SDK, where this separation is shown by sub-routines. Most of the AlazarDSP function calls fall into the second category. This means that the board configuration routine of the existing code samples is left mostly untouched.

Programs that use the AlazarDSP API need to get the handle of the DSP module they want to use. This is done by calling `AlazarDSPGetModules()`. Information about the DSP module can be retrieved at any time using `AlazarDSPGetInfo()`.

The board configuration section is left untouched when compared to a standard AutoDMA NPT acquisition.

In the data acquisition section, the following changes must be made:

1. `AlazarSetRecordSize()` is not called. This function is called internally by `AlazarFFTSetup()`.
2. `AlazarFFTSetup()` is called **before** `AlazarBeforeAsyncRead()` and *before* allocating the DMA buffers. This is due to the fact that the number of bytes of data returned by the FFT engine may vary from one mode to the next, e.g. U16 log of amplitude output, U32 real part, etc. `AlazarFFTSetup()` returns the effective number of bytes per record that need to be allocated and passed to `AlazarBeforeAsyncRead()`
3. `AlazarBeforeAsyncRead()` is called by passing:
 - a. The number of *bytes* per record to the fourth parameter (*SamplesPerRecord*)
 - b. `0x7FFFFFFF` to *RecordsPerAcquisition*
4. `AlazarWaitAsyncBufferComplete()` is replaced with `AlazarDSPGetBuffer()`.

- AlazarAbortAsyncRead() is replaced with AlazarDSPAbortCapture().

4.2 Detailed Description

4.2.1 DSP Module Variations

Features offered by DSP processing modules can vary from one board to another. An example of such variation is the maximum record size, which is generally lower on ATS9350 than on other board models. In order to query these information at runtime, AlazarDSP offers the AlazarDSPGetInfo() function. A generic interface to retrieve parameters has also been added with AlazarDSPGetParameterU32(). Each call to this function allows to retrieve one attribute of a DSP module. Available attributes to query are listed in DSP_PARAMETERS.

In addition, FFT module have specific parameters that are not indicated by AlazarDSPGetInfo(). For these modules, another introspection method is AlazarFFTGetMaxTriggerRepeatRate(). The maximum FFT input length can be read from the maxLength output parameter of AlazarDSPGetInfo().

4.2.2 FFT Module Output Data

The output data format of the FFT module is determined by the outputFormat parameter to AlazarFFTSetup(). This parameter can be any element of the FFT_OUTPUT_FORMAT enumeration except FFT_OUTPUT_FORMAT_RAW_PLUS_FFT, optionnaly OR'ed with FFT_OUTPUT_FORMAT_RAW_PLUS_FFT. The meaning of each element is described in FFT_OUTPUT_FORMAT.

If the RAW + FFT mode is selected, a number of samples that correspond to the FFT length is prepended to each record during the output. These samples contain the acquired time-domain data in U16 format, followed with padding to bring the number of samples to the FFT input length.

On the board, the Fourier Transform output is a 53-bit unsigned integer that gets converted in various blocks to match the requested output format. Along the conversion, it is possible to set a scaling a slicing parameter. These values are set to sane default in AlazarFFTSetup(). It is possible however for users to change these values manually, using the AlazarFFTSetScalingAndSlicing() function. The block diagram below shows where the conversions happen.

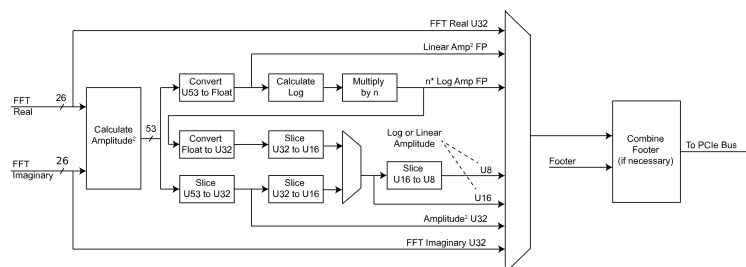

4.2.3 Background Subtraction

Starting with version 4.6, the on-FPGA FFT module offers a background subtraction feature. A record to subtract is downloaded on the board with `AlazarFFTBackgroundSubtractionSetRecordS16()`, and the feature is activated by `AlazarFFTBackgroundSubtractionSetEnabled()`.

Once background subtraction is enabled, the background is subtracted to all acquired time-domain records before they are sent in the FFT processing module.

It is not necessary to re-download the background record in between multiple acquisitions in the same program. The downloaded record remains on the board. On the other hand, the default background record should not be assumed to be made of zeros. As the values *can* remain in the board, even after a reboot of the computer.

For 12-bit digitizers, the record is downloaded at 16 bits per sample, but only the 12 most significant bits are actually used. The 4 least significant bits are discarded. This behavior is consistent with the way the boards acquire and send data back to user applications.

ADVANCED TOPICS**5.1 External clock issues for OCT applications**

The external clocking feature of AlazarTech boards is commonly used in Optical Coherence Tomography (OCT) applications, where swept laser sources generate a signal to be used for clocking the acquisition. However, in some cases the external clock signal does not meet the requirements of the digitizers, which can lead to various issues. This section discusses the steps that need to be taken to diagnose and troubleshoot external clock problems.

5.1.1 Diagnose external clock issues

External clock issues can be of two natures; trigger jumps, or unexpected (glitchy) acquired data. These issues can also arise as the result of a board misconfiguration (bad record length, bad trigger configuration...). Before proceeding with the external clock troubleshooting, you *must* ensure that the external clock is indeed the cause of your problems. One way to do that is to make sure that your acquisition works fine when using the internal clock. Another way is to reproduce your acquisition configuration in AlazarDSO, and make sure that the problem also shows up there. Once having made sure that the external clock is the issue, the next step is to identify the problematic regions of the signal. To do this, please acquire a few record acquisition cycles (laser sweeps) with a high speed oscilloscope (ideally 20GS/s, 4GHz), and to send the results to us.

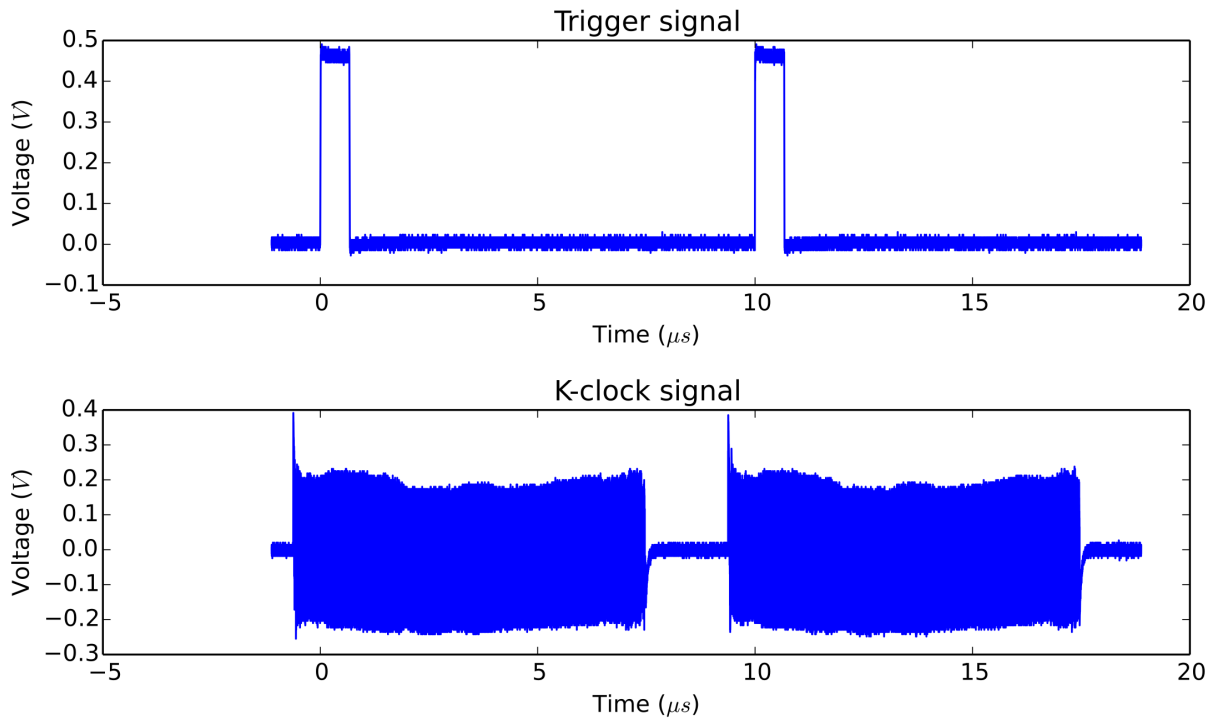

Fig. 1: External Clock Measurement

Here is an example of an external clock analysis plot, annotated to show the problem:

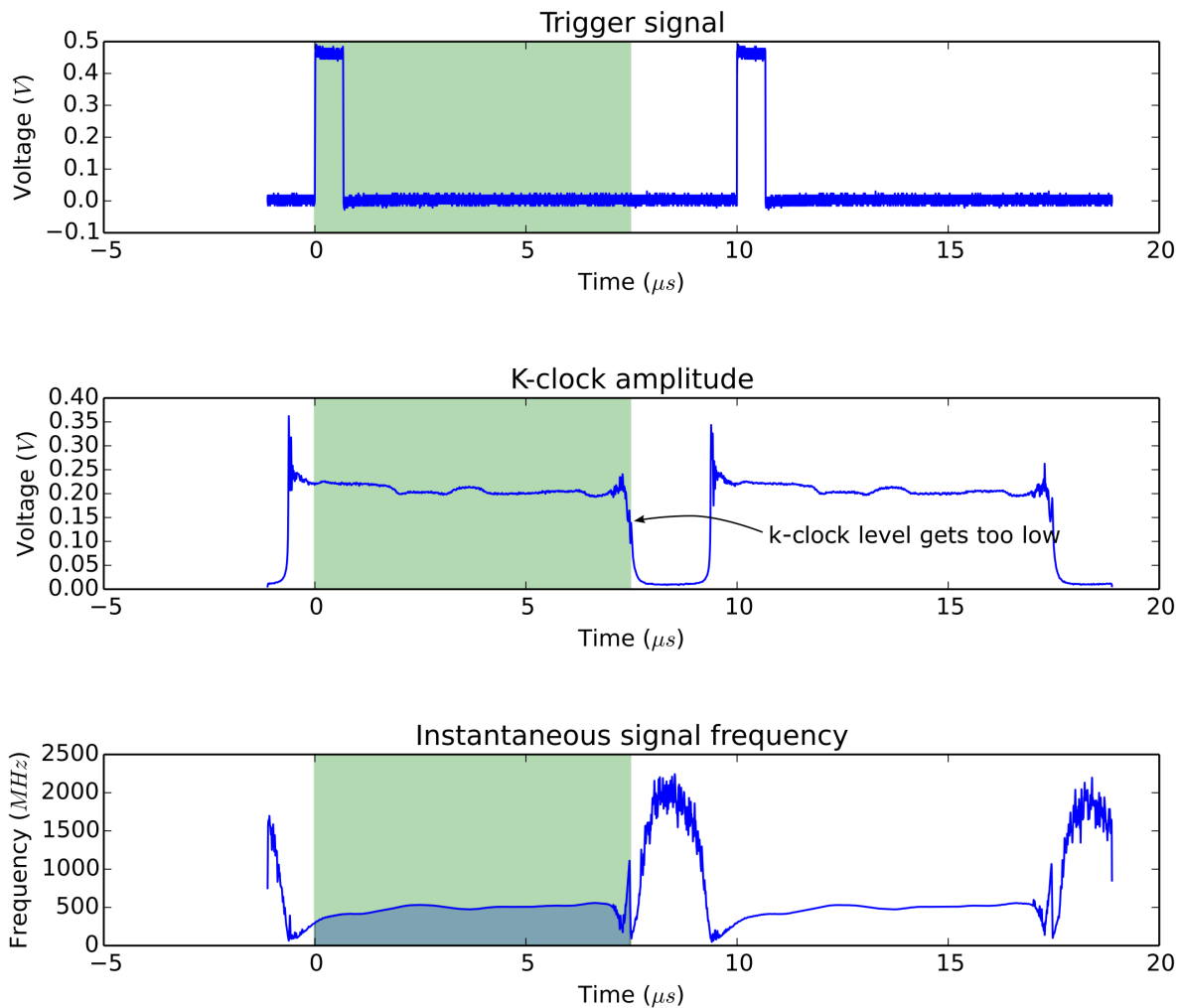

Fig. 2: Example of external clock analysis

5.1.2 Using `AlazarOCTIgnoreBadClock()` to solve external clock issues

Some AlazarTech digitizers support a feature called *OCT Ignore Bad Clock*, which can be used to make the board *ignore* the external clock signal for a given period of time. This can be used if the external clock signal is bad when the board is not acquiring data. Note that the external clock signal *must* be good when trigger events are received, and when the board needs to acquire data.

In order to activate *OCT Ignore Bad Clock*, customers must first measure how long the external clock signal is *good*¹ after the trigger event, and how long it is bad. For example, the data of the [Example of external clock analysis](#) figure shows that the clock signal stays good

¹ The external clock signal is considered good when it meets the digitizer's specified limits in terms of amplitude and frequency. The limits can be found on the digitizer's datasheet.

for $\sim 7.5\mu\text{s}$, then goes bad for $\sim 2\mu\text{s}$.

The values of “good clock duration” and “bad clock duration” must add up to less than the trigger period, to ensure that the board is back to accepting the external clock before each trigger event. As an example, the data of the [Example of external clock analysis](#) shows that the trigger period is $10\mu\text{s}$. This is compatible with choosing values of $7.5\mu\text{s}$ and $2\mu\text{s}$ for good and bad clock durations respectively.

Once these values are known, the only change that is required to add *OCT Ignore Bad Clock* to an existing application is to call `AlazarOCTIgnoreBadClock()` in the board configuration section of the application.

5.2 Multi-Threading Considerations

It is possible to use ATSApi in the context of a multi-threaded program. However, all calls to functions exported by ATSApi should be done from a single, long-lived thread. None of the APIs exported by ATSApi are thread-safe, which means that calling multiple functions simultaneously from multiple threads triggers undefined behaviour. The thread used for communication with ATSApi must not be created or destroyed during the process of an acquisition, since the operating system is notified of these events and causes critical resources to be cleared.

A common paradigm for applications using ATSApi is to dedicate a worker thread to communication with ATSApi, and to use a message queue for this thread to communicate safely with the rest of the application.

API REFERENCE**Board configuration functions:**

- [AlazarConfigureAuxIO\(\)](#)
- [AlazarConfigureLSB\(\)](#)
- [AlazarConfigureSampleSkipping\(\)](#)
- [AlazarInputControl\(\)](#)
- [AlazarInputControlEx\(\)](#)
- [AlazarOCTIgnoreBadClock\(\)](#)
- [AlazarSetADCBackgroundCompensation\(\)](#)
- [AlazarSetBWLlimit\(\)](#)
- [AlazarSetCaptureClock\(\)](#)
- [AlazarSetExternalClockLevel\(\)](#)
- [AlazarSetExternalTrigger\(\)](#)
- [AlazarSetParameter\(\)](#)
- [AlazarSetParameterLL\(\)](#)
- [AlazarSetParameterUL\(\)](#)
- [AlazarSetTriggerDelay\(\)](#)
- [AlazarSetTriggerOperation\(\)](#)
- [AlazarSetTriggerOperationForScanning\(\)](#)
- [AlazarSetTriggerTimeOut\(\)](#)
- [AlazarSleepDevice\(\)](#)

Generic acquisition functions:

- [AlazarResetTimeStamp\(\)](#)
- [AlazarSetRecordSize\(\)](#)
- [AlazarStartCapture\(\)](#)

Dual-port acquisition functions:

- [AlazarAbortAsyncRead\(\)](#)
- [AlazarAllocBufferU16\(\)](#)
- [AlazarAllocBufferU16Ex\(\)](#)
- [AlazarAllocBufferU8\(\)](#)
- [AlazarAllocBufferU8Ex\(\)](#)
- [AlazarAsyncRead\(\)](#)
- [AlazarBeforeAsyncRead\(\)](#)
- [AlazarCreateStreamFileA\(\)](#)
- [AlazarCreateStreamFileW\(\)](#)
- [AlazarFreeBufferU16\(\)](#)
- [AlazarFreeBufferU16Ex\(\)](#)
- [AlazarFreeBufferU8\(\)](#)
- [AlazarFreeBufferU8Ex\(\)](#)
- [AlazarPostAsyncBuffer\(\)](#)
- [AlazarWaitAsyncBufferComplete\(\)](#)
- [AlazarWaitNextAsyncBufferComplete\(\)](#)

Single-port acquisition functions:

- [AlazarAbortCapture\(\)](#)
- [AlazarBusy\(\)](#)
- [AlazarConfigureRecordAverage\(\)](#)
- [AlazarGetStatus\(\)](#)
- [AlazarGetTriggerAddress\(\)](#)
- [AlazarGetTriggerTimestamp\(\)](#)
- [AlazarGetWhoTriggeredBySystemHandle\(\)](#)

- AlazarGetWhoTriggeredBySystemID()
- AlazarHyperDisp()
- AlazarRead()
- AlazarReadEx()
- AlazarSetRecordCount()
- AlazarTriggered()

DSP functions:

- AlazarDSPAbortCapture()
- AlazarDSPGenerateWindowFunction()
- AlazarDSPGetBuffer()
- AlazarDSPGetInfo()
- AlazarDSPGetModules()
- AlazarDSPGetNextBuffer()
- AlazarDSPGetParameterFloat()
- AlazarDSPGetParameterS32()
- AlazarDSPGetParameterU32()
- AlazarDSPSetParameterFloat()
- AlazarDSPSetParameterS32()
- AlazarDSPSetParameterU32()

on-FPGA FFT functions:

- AlazarFFTBackgroundSubtractionGetRecordS16()
- AlazarFFTBackgroundSubtractionSetEnabled()
- AlazarFFTBackgroundSubtractionSetRecordS16()
- AlazarFFTGetMaxTriggerRepeatRate()
- AlazarFFTSetScalingAndSlicing()
- AlazarFFTSetup()
- AlazarFFTSetWindowFunction()
- AlazarFFTSetGainAndOffset()

Miscellaneous functions:

- AlazarBoardsFound()
- AlazarBoardsInSystemByHandle()
- AlazarBoardsInSystemBySystemID()
- AlazarCoproprocessorDownloadA()
- AlazarCoproprocessorDownloadW()
- AlazarCoproprocessorRegisterRead()
- AlazarCoproprocessorRegisterWrite()
- AlazarErrorToText()
- AlazarExtractFFTNPTFooters()
- AlazarExtractTimeDomainNPTFooters()
- AlazarForceTrigger()
- AlazarForceTriggerEnable()
- AlazarGetBoardBySystemHandle()
- AlazarGetBoardBySystemID()
- AlazarGetBoardKind()
- AlazarGetBoardRevision()
- AlazarGetCPLDVersion()
- AlazarGetChannelInfo()
- AlazarGetChannelInfoEx()
- AlazarGetDriverVersion()
- AlazarGetFPGAVersion()
- AlazarGetMaxRecordsCapable()
- AlazarGetParameter()
- AlazarGetParameterLL()
- AlazarGetParameterUL()
- AlazarGetSDKVersion()
- AlazarGetSystemHandle()
- AlazarNumOfSystems()
- AlazarQueryCapability()
- AlazarQueryCapabilityLL()
- AlazarSetLED()

Deprecated functions:

- AlazarOpen
- AlazarClose
- AlazarExtractNPTFootersEx
- AlazarExtractFFTNPTFooters
- AlazarExtractTimeDomainNPTFooters

6.1 AlazarAbortAsyncRead

6.1.1 Function Syntax

RETURN_CODE AlazarAbortAsyncRead(HANDLE handle)

Aborts a dual-port acquisition, and any in-process DMA transfers.

Remark

If you have started an acquisition and/or posted DMA buffers to a board, you *must* call *AlazarAbortAsyncRead()* before your application exits. If you do not, when your program exists, Microsoft Windows may stop with a blue screen error number 0x000000CB (DRIVER_LEFT_LOCKED_PAGES_IN_PROCESS). Linux may leak the memory used by the DMA buffers.

Note: This function is part of the dual-port API. It should be used only in this context. To abort single-port acquisitions using, see *AlazarAbortCapture()*.

Parameters

- handle – **[in]** Handle to board

Returns

ApiSuccess upon success, or an error code. See *RETURN_CODE* for more detailed information.

6.1.2 LabVIEW Block Diagram

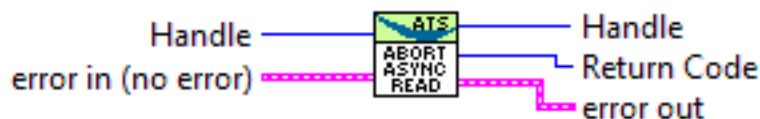

6.2 AlazarAbortCapture

6.2.1 Function Syntax

RETURN_CODE AlazarAbortCapture(HANDLE handle)

Abort an acquisition to on-board memory.

Note: This function is part of the single-port API. It should be used only in this context. To abort dual-port acquisitions, see *AlazarAbortAsyncRead()*.

Parameters

- handle – **[in]** Board handle

Returns

ApiSuccess upon success, or an error code. See [RETURN_CODE](#) for more detailed information.

6.2.2 LabVIEW Block Diagram



6.3 AlazarAllocBufferU16

6.3.1 Function Syntax

U16 *AlazarAllocBufferU16(HANDLE handle, U32 byteCount)
 Allocates a buffer for DMA transfer for an 16-bit digitizer.

Remark

The buffer must be freed using [AlazarFreeBufferU16\(\)](#)

Parameters

- handle – **[in]** Handle to board
- byteCount – **[in]** Buffer size in bytes

Returns

If the function is successful, it returns the base address of a page-aligned buffer in the virtual address space of the calling process. If it fails, it returns NULL.

6.4 AlazarAllocBufferU16Ex

6.4.1 Function Syntax

U16 *AlazarAllocBufferU16Ex(HANDLE handle, U64 byteCount)
 This function acts like [AlazarAllocBufferU16\(\)](#) and additionally allows allocation of a buffer over 4GS for DMA transfer for an 16-bit digitizer.

Remark

The buffer must be freed using [AlazarFreeBufferU16Ex\(\)](#)

Parameters

- handle – **[in]** Handle to board
- byteCount – **[in]** Buffer size in bytes

Returns

If the function is successful, it returns the base address of a page-aligned buffer in the virtual address space of the calling process. If it fails, it returns NULL.

6.5 AlazarAllocBufferU8

6.5.1 Function Syntax

U8 *AlazarAllocBufferU8(HANDLE handle, U32 byteCount)

Allocates a buffer for DMA transfer for an 8-bit digitizer.

Remark

The buffer must be freed using [AlazarFreeBufferU8\(\)](#)

Parameters

- handle – **[in]** Handle to board
- byteCount – **[in]** Buffer size in bytes

Returns

If the function is successful, it returns the base address of a page-aligned buffer in the virtual address space of the calling process. If it fails, it returns NULL.

6.6 AlazarAllocBufferU8Ex

6.6.1 Function Syntax

U8 *AlazarAllocBufferU8Ex(HANDLE handle, U64 byteCount)

This function acts like [AlazarAllocBufferU8\(\)](#) and additionally allows allocation of a buffer over 4GS for DMA transfer for an 8-bit digitizer.

Remark

The buffer must be freed using [AlazarFreeBufferU8Ex\(\)](#)

Parameters

- handle – **[in]** Handle to board
- byteCount – **[in]** Buffer size in bytes

Returns

If the function is successful, it returns the base address of a page-aligned buffer in the virtual address space of the calling process. If it fails, it returns NULL.

6.7 AlazarAsyncRead

6.7.1 Function Syntax

RETURN_CODE AlazarAsyncRead(HANDLE handle, void *buffer, U32 bytesToRead, OVERLAPPED *overlapped)

Adds a buffer to the end of a list of available buffers to be filled by the board. When the board receives sufficient trigger events to fill the buffer, the event in the OVERLAPPED will be set to the signaled state.

You must call [AlazarBeforeAsyncRead\(\)](#) before calling [AlazarAsyncRead\(\)](#).

The bytesToRead parameter must be equal to the product of the number of bytes per record, the number of records per buffer and the number of enabled channels. If record headers are enabled, the number of bytes per record must include the size of the record header (16 bytes).

Remark

[AlazarAsyncRead\(\)](#) is only available under Windows

Warning: You must call [AlazarAbortAsyncRead\(\)](#) before your application exits if you have called [AlazarAsyncRead\(\)](#) and buffers are pending.

Parameters

- handle – **[in]** Handle to board
- buffer – **[in]** Pointer to a buffer to receive sample data from the digitizer board
- bytesToRead – **[in]** Number of bytes to read from the board
- overlapped – **[in]** Pointer to an OVERLAPPED structure. The event in the structure is set to the signaled state when the read operation completes.

Returns

If the function succeeds in adding the buffer to end of the list of buffers available to be filled by the board, it returns *ApiDmaPending*. When the board fills the buffer, the event in the OVERLAPPED structure is set to the signaled state.

Returns

If the function fails because the board overflowed its on board memory, it returns *ApiBufferOverflow*. The board may overflow its on board memory because the rate at which it is acquiring data is faster than the rate at which it is transferring data from on-board memory to host memory. If this is the case, try reducing the sample rate, number of enabled channels, or amount of time spent processing each buffer.

Returns

If the function fails because the buffer is too large for the driver or operating system to prepare for scatter-gather DMA transfer, it returns *ApiLockAndProbePagesFailed*. Try reducing the size of each buffer, or reducing the number of buffers queued by the application.

Returns

If the function fails for some other reason, it returns an error code that indicates the reason that it failed. See *RETURN_CODE* for more information.

6.8 AlazarBeforeAsyncRead

6.8.1 Function Syntax

RETURN_CODE AlazarBeforeAsyncRead(HANDLE handle, U32 channelSelect, long transferOffset, U32 transferLength, U32 recordsPerBuffer, U32 recordsPerAcquisition, U32 flags)

Configure a board to make an asynchronous AutoDMA acquisition.

In non-DSP mode, when record headers are not enabled, the total number of bytes per AutoDMA buffer is given by:

```
bytesPerBuffer = bytesPerSample * samplesPerRecord * recordsPerBuffer;
```

When record headers are enabled, the formula changes to:

```
bytesPerBuffer = (16 + bytesPerSample * samplesPerRecord) *
recordsPerBuffer;
```

For best performance, AutoDMA parameters should be selected so that the total number of bytes per buffer is greater than about 1 MB. This allows for relatively long DMA transfer times compared to the time required to prepare a buffer for DMA transfer and re-arm the DMA engines.

ATS460, ATS660 and ATS860 digitizer boards require that AutoDMA parameters be selected so that the total number of bytes per buffer is less than 4 MB. Other boards require that the total number of bytes per buffer be less than 64 MB. It is however recommended to keep the DMA buffer size below 16 MB for all boards.

Remark

`transferLength` must meet certain alignment criteria which depend on the board model and the acquisition type. Please refer to board-specific documentation for more information.

Remark

`recordsPerBuffer` must be set to 1 in continuous streaming and triggered streaming AutoDMA modes.

Remark

`recordsPerAcquisition` must be `0x7FFFFFFF` in Continuous Streaming and Triggered Streaming modes. The acquisition runs continuously until [AlazarAbortAsyncRead\(\)](#) is called. In other modes, it must be either:

- A multiple of `recordsPerBuffer`
- `0x7FFFFFFF` to indicate that the acquisition should continue indefinitely.

Parameters

- `handle` – **[in]** Handle to board
- `channelSelect` – **[in]** Select the channel(s) to control. This can be one or more of the channels of [ALAZAR_CHANNELS](#), assembled with the OR bitwise operator.
- `transferOffset` – **[in]** Specify the first sample from each on-board record to transfer from on-board to host memory. This value is a sample relative to the trigger position in an on-board record.
- `transferLength` – **[in]** Specify the number of samples from each record to transfer from on-board to host memory. In DSP-mode, it takes the number of bytes instead of samples. See remarks.
- `recordsPerBuffer` – **[in]** The number of records in each buffer. See remarks.
- `recordsPerAcquisition` – **[in]** The number of records to acquire during one acquisition. Set this value to `0x7FFFFFFF` to acquire indefinitely until the acquisition is aborted. This parameter is ignored in Triggered Streaming and Continuous Streaming modes. See remarks.
- `flags` – **[in]** Specifies AutoDMA mode and option. Must be one element of [ALAZAR_ADMA_MODES](#) combined with zero or more element(s) of [ALAZAR_ADMA_FLAGS](#) using the bitwise OR operator.

Returns

ApiSuccess upon success, or an error code. See [RETURN_CODE](#) for more detailed information.

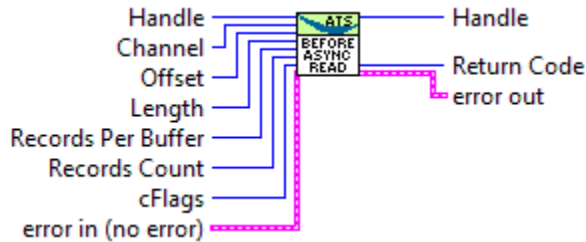
6.8.2 LabVIEW Block Diagram**6.8.3 Related Enumerations**

enum ALAZAR_ADMA_MODES

AutoDMA acquisition modes. See [AlazarBeforeAsyncRead\(\)](#).

Values:

enumerator ADMA_TRADITIONAL_MODE

0x00000000 Acquire multiple records: one per trigger event. Each record may include pre-and post-trigger samples, and a record header that includes its trigger timestamp. If a board has on-board memory and sample interleave is not enabled, each buffer will contain samples organized as follows: R1A, R1B, R2A, R2B ...

If a board does not have on-board memory, or sample interleave is enabled, the buffer will contain samples organized as follows: R1[AB...], R2[AB...] ...

enumerator ADMA_CONTINUOUS_MODE

0x00000100 Acquire a single, gapless record spanning multiple buffers. Do not wait for trigger event before starting the acquisition.

If a board has on-board memory and sample interleave is not enabled, each buffer will contain samples organized as follows: R1A, R1B.

If a board does not have on-board memory, or sample interleave is enabled, the buffer will contain samples organized as follows: R1[AB...]

enumerator ADMA_NPT

0x00000200 Acquire multiple records: one per trigger event. Each record contains only post-trigger samples.

If a board has on-board memory and sample interleave is not enabled, each buffer will contain samples organized as follows: R1A, R2A, ... R1B, R2B ...

If a board does not have on-board memory, or sample interleave is enabled, the buffer will contain samples organized as follows: R1[AB...], R2[AB...] ...

enumerator ADMA_TRIGGERED_STREAMING

0x00000400 Acquire a single, gapless record spanning multiple buffers. Wait for a trigger event before starting the acquisition.

If a board has on-board memory and sample interleave is not enabled, each buffer will contain samples organized as follows: R1A, R1B.

If a board does not have on-board memory, or sample interleave is enabled, the buffer will contain samples organized as follows: R1[AB...]

enum ALAZAR_ADMA_FLAGS

AutoDMA acquisition options. See [AlazarBeforeAsyncRead\(\)](#).

Values:

enumerator ADMA_EXTERNAL_STARTCAPTURE

0x00000001 The acquisition only starts when [AlazarStartCapture\(\)](#) is called if this flag is set. Otherwise, it starts before the current function returns.

enumerator ADMA_ENABLE_RECORD_HEADERS

0x00000008 If this flag is set, precede each record in each buffer with a 16-byte header that includes the record's trigger timestamp.

Note that this flag can only be used in "traditional" AutoDMA mode. Record headers are not available in NPT, streaming, or triggered streaming modes.

enumerator ADMA_ALLOC_BUFFERS

0x00000020 If this flag is set, the API will allocate and manage a list of DMA buffers. This flag may be used by LabVIEW, and in other high-level development environments, where it may be more convenient for the application to let the API manage a list of DMA buffers, and to receive a copy of data in an application buffer. When this flag is set, the application must call [AlazarWaitNextAsyncBufferComplete\(\)](#) to wait for a buffer to complete and receive a copy of the data. The application can specify the number of DMA buffers for the API to allocate by calling [AlazarSetParameter](#) with the parameter [SETGET_ASYNC_BUFFCOUNT](#) before calling [AlazarBeforeAsyncRead](#).

enumerator ADMA_FIFO_ONLY_STREAMING

0x00000800 Enable the board to data from its on-FPGA FIFO rather than from on-board memory. When the flag is set, each buffer contains data organized as fol-

lows: R0[ABAB...], R1[ABAB...], R2[ABAB] That is, each sample from CH A is followed by a sample from CH B.

When this flag is not set, each record in a buffer contains a contiguous array of samples for CH A followed by a contiguous array of samples for CH B, where the record arrangement depends on the acquisition mode. Note that this flag must be set if your board does not have on-board memory. For example, an ATS9462-FIFO requires this flag. Also note that this flag must not be set if your board has on-board memory.

enumerator ADMA_INTERLEAVE_SAMPLES

0x00001000 Enable a board to interleave samples from both digitizer channels in dual-channel acquisition mode. This results in higher data transfer rates on boards that support this option.

Note that this flag has no effect in single channel mode, and is supported by only PCIe digitizers (except the ATS9462).

When the flag is set, each buffer contains data organized as follows: R0[ABAB...], R1[ABAB...], R2[ABAB] That is, each sample from CH A is followed by a sample from CH B.

When this flag is not set, each record in a buffer contains a contiguous array of samples for CH A followed by a contiguous array of samples for CH B, where the record arrangement depends on the acquisition mode.

enumerator ADMA_GET_PROCESSED_DATA

0x00002000 Enable the API to process each buffer So that the sample data in a buffer is Always arranged as in NPT mode: R0A, R1A, R2A, ... RB0, R1B, R2B.

If this flag is not set, the data Arrangement in a buffer depends on The acquisition mode.

LabVIEW and other higher-level Applications may use this flag to Simplify data processing since all data Buffers will have the same Arrangement independent of the Acquisition mode.

Note that the [ADMA_ALLOC_BUFFERS](#) flag Must also be set to use this option.

enumerator ADMA_DSP

0x00004000 Activates the DSP mode that must be used for using the on-FPGA DSP modules such as the on-FPGA FFT.

enumerator ADMA_ENABLE_RECORD_FOOTERS

0x00010000 Activate record footers, that are appended to each acquired record. Please note that this feature is not available on all boards, and can only be activated in NPT mode.

enumerator ADMA_PARALLEL_DMA

0x00020000 Activates the parallel DMA buffer data transfer. When this is active, each DMA buffer contains data associated with a single input channel. The first buffer acquired contains exclusively data from channel A, the second contains data from channel B, etc. This feature is only available for multi-channel acquisitions on specific digitizers. Consult board-specific documentation for more details.

struct `_ALAZAR_HEADER`
Traditional Record Header.

Public Members

struct `_HEADER0` `hdr0`
Substructure 0.

struct `_HEADER1` `hdr1`
Substructure 1.

struct `_HEADER2` `hdr2`
Substructure 2.

struct `_HEADER3` `hdr3`
Substructure 3.

struct `_HEADER0`
Traditional Record Header Substructure 1.

Public Members

unsigned int `SerialNumber`
18-bit serial number of this board as a signed integer

unsigned int `SystemNumber`
4-bit system identifier number for this board

unsigned int `WhichChannel`
1-bit input channel of this header. 0 is channel A, 1 is channel B

unsigned int BoardNumber
4-bit board identifier number of this board

unsigned int SampleResolution
3-bit reserved field

unsigned int DataFormat
2-bit reserved field

struct _HEADER1
Traditional Record Header Substructure 1.

Public Members

unsigned int RecordNumber
24-bit index of record in the acquisition

unsigned int BoardType
8-bit board type identifier. See [BoardTypes](#) for a list of existing board types.

struct _HEADER2
Traditional Record Header Substructure 2.

Public Members

unsigned int TimeStampLowPart
Lower 32 bits of 40-bit record timestamp.

struct _HEADER3
Traditional Record Header Substructure 3.

Public Members

unsigned int TimeStampHighPart
8-bit field containing the upper part of the 40-bit record timestamp

unsigned int ClockSource
2-bit clock source identifier. See [ALAZAR_CLOCK_SOURCES](#)

unsigned int ClockEdge

1-bit clock edge identifier. See [ALAZAR_CLOCK_EDGES](#)

unsigned int SampleRate

7-bit sample rate identifier. See [ALAZAR_SAMPLE_RATES](#)

unsigned int InputRange

5-bit input range identifier. See [ALAZAR_INPUT_RANGES](#)

unsigned int InputCoupling

2-bit input coupling identifier. See [ALAZAR_COUPLINGS](#)

unsigned int InputImpedance

2-bit input impedance identifier. See [ALAZAR_IMPEDANCES](#)

unsigned int ExternalTriggered

1-bit field set if and only if TRIG IN on this board caused the board to

unsigned int ChannelBTriggered

capture this record.

1-bit field set if and only if CH B on this board caused the board to

unsigned int ChannelATriggered

capture this record.

1-bit field set if and only if CH A on this board caused the board to

unsigned int TimeOutOccurred

capture this record.

1-bit field set if and only if a timeout on a trigger engine on this

unsigned int ThisChannelTriggered

board caused it to capture this record.

1-bit field set if and only if the channel specified by [_HEADER0::WhichChannel](#) caused the

6.9 AlazarBoardsFound

6.9.1 Function Syntax

U32 AlazarBoardsFound(void)

Determine the number of digitizer boards that were detected in all board systems.

See

[AlazarNumOfSystems\(\)](#)

Returns

The total number of digitizer boards detected.

6.9.2 LabVIEW Block Diagram



6.10 AlazarBoardsInSystemByHandle

6.10.1 Function Syntax

U32 AlazarBoardsInSystemByHandle(HANDLE systemHandle)

Return the number of digitizer boards in a board system specified by the handle of its master board.

If this function is called with the handle of to the master board in a master-slave system, it returns the total number of boards in the system.

If this function is called with the handle of an independent board, it returns 1.

If it is called with the handle to a slave in a master-slave system or with an invalid handle, it returns 0.

Returns

[ApiSuccess](#) upon success, or an error code. See [RETURN_CODE](#) for more detailed information.

6.10.2 LabVIEW Block Diagram



6.11 AlazarBoardsInSystemBySystemID

6.11.1 Function Syntax

U32 AlazarBoardsInSystemBySystemID(U32 systemId)

Returns the number of digitizer boards in a board system specified by its system identifier.

If this function is called with the identifier of a master-slave system, it returns the total number of boards in the system, including the master.

If this function is called with the identifier of an independent board system, it returns one.

If this function is called with the identifier of an invalid board system, it returns zero.

Parameters

- systemId – **[in]** The system identification number

Returns

ApiSuccess upon success, or an error code. See [RETURN_CODE](#) for more detailed information.

6.11.2 LabVIEW Block Diagram



6.12 AlazarBusy

6.12.1 Function Syntax

U32 AlazarBusy(HANDLE handle)

Determines if an acquisition is in progress.

Note: This function is part of the single-port data acquisition API. It cannot be used with the dual-port AutoDMA APIs.

Parameters

- handle – **[in]** Board handle

Returns

If the board is busy acquiring data to on-board memory, this function returns 1. Otherwise, it returns 0.

6.12.2 LabVIEW Block Diagram

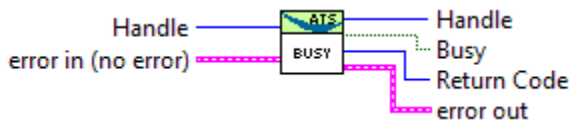

6.13 AlazarConfigureAuxIO

6.13.1 Function Syntax

RETURN_CODE AlazarConfigureAuxIO(HANDLE handle, U32 mode, U32 parameter)

Configures the AUX I/O connector as an input or output signal.

The AUX I/O connector generates TTL level signals when configured as an output, and expects TTL level signals when configured as an input.

AUX I/O output signals may be limited by the bandwidth of the AUX output drivers.

Remark

The ATS9440 has two AUX I/O connectors: AUX 1 and AUX 2. AUX 1 is configured by firmware as a trigger output signal, while AUX 2 is configured by software using [AlazarConfigureAuxIO\(\)](#). A firmware update is required to change the operation of AUX 1.

Remark

ATS9625 and ATS9626 have two AUX I/O connectors; AUX 1 and AUX 2. AUX 1 is configured by software using [AlazarConfigureAuxIO\(\)](#), while AUX 2 is configured by default as a trigger output signal. A custom user-programmable FPGA can control the operation of AUX 2 as required by the FPGA designer.

Parameters

- handle – **[in]** Handle to board
- mode – **[in]** The AUX I/O mode. Can be selected from [ALAZAR_AUX_IO_MODES](#). If an output mode is selected, the parameter may be OR'ed with AUX_OUT_TRIGGER_ENABLE to enable the board to use software trigger enable. When this flag is set, the board will wait for software to call [AlazarForceTriggerEnable\(\)](#) to

generate a trigger enable event; then wait for sufficient trigger events to capture the records in an AutoDMA buffer; then wait for the next trigger enable event and repeat.

- parameter – **[in]** The meaning of this value varies depending on mode. See [ALAZAR_AUX_IO_MODES](#) for more details.

Returns

ApiSuccess upon success, or an error code. See [RETURN_CODE](#) for more detailed information.

6.13.2 LabVIEW Block Diagram

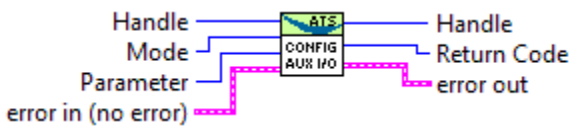

6.13.3 Related Enumerations

enum ALAZAR_AUX_IO_MODES

Alazar AUX I/O identifiers.

Values:

enumerator AUX_OUT_TRIGGER

0U Outputs a signal that is high whenever data is being acquired to on-board memory, and low otherwise. The parameter argument of [AlazarConfigureAuxIO\(\)](#) is ignored in this mode.

enumerator AUX_IN_TRIGGER_ENABLE

1U Uses the edge of a pulse to the AUX I/O connector as an AutoDMA *trigger enable* signal. Please note that this is different from a standard *trigger* signal. In this mode, the parameter argument of [AlazarConfigureAuxIO\(\)](#) can take an element of [ALAZAR_TRIGGER_SLOPES](#), which defines on which edge of the input signal a trigger enable event is generated.

enumerator AUX_OUT_PACER

2U Outputs a signal with a frequency related to the sample clock on the AUX I/O output. The frequency of the signal output is the sample clock divided by the parameter to the call to [AlazarConfigureAuxIO\(\)](#), then divided by the number of samples per timestamp (See board-specific information table in ATS-SDK guide).

For example, using an ATS9416 with 1 channel active at 100 MS/s and a pacer divider parameter of 200, the pacer frequency will be $100 \text{ MS/s} / 200 / 16 = 31.25 \text{ kHz}$.

Note: The pacer output is generated by an internal FPGA clock, so there may be some jitter with the sample clock.

Note: The divider value passed to the parameter parameter of [AlazarConfigureAuxIO\(\)](#) must be greater than 2.

enumerator AUX_OUT_SERIAL_DATA

14U Use the AUX I/O connector as a general purpose digital output. The parameter argument of [AlazarConfigureAuxIO\(\)](#) specifies the TTL output level. 0 means TTL low level, whereas 1 means TTL high level.

enumerator AUX_IN_AUXILIARY

13U Configure the AUX connector as a digital input. Call [AlazarGetParameter\(\)](#) with [GET_AUX_INPUT_LEVEL](#) to read the digital input level.

6.14 AlazarConfigureLSB

6.14.1 Function Syntax

RETURN_CODE AlazarConfigureLSB(HANDLE handle, U32 valueLsb0, U32 valueLsb1)

Repurposes unused least significant bits in 12- and 14-bit boards.

12- and 14-bit digitizers return 16-bit sample values per sample by default, with the actual sample codes stored in the most significant bits. By default, the least significant bits of each sample value are zero-filled. Use this option to use these otherwise unused bits as digital outputs.

This feature is not available on all boards. See board-specific documentation for more information.

Parameters

- handle – **[in]** Handle to board
- valueLsb0 – **[in]** Specifies the signal to output to the least significant bit of each sample value. Must be one of [ALAZAR_LSB](#).
- valueLsb1 – **[in]** Specifies the signal to output to the least significant bit of each sample value. Must be one of [ALAZAR_LSB](#).

Returns

[ApiSuccess](#) upon success, or an error code. See [RETURN_CODE](#) for more detailed information.

6.14.2 LabVIEW Block Diagram

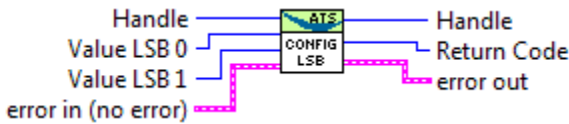

6.14.3 Related Enumerations

enum ALAZAR_LSB

Least significant bit identifiers.

Values:

enumerator LSB_DEFAULT

0 Default LSB setting

enumerator LSB_EXT_TRIG

1 Use external trigger state as LSB

enumerator LSB_AUX_IN_2

2 Use AUX I/O 2 state as LSB

enumerator LSB_AUX_IN_1

3 Use AUX I/O 1 state as LSB

6.15 AlazarConfigureRecordAverage

6.15.1 Function Syntax

RETURN_CODE AlazarConfigureRecordAverage(HANDLE handle, U32 mode, U32 samplesPerRecord, U32 recordsPerAverage, U32 options)

Configures a digitizer to co-add ADC samples from a specified number of records in an accumulator record, and transfer accumulator records rather than the ADC sample values.

When FPGA record averaging is enabled, the digitizer transfers one accumulator record to host memory after `recordsPerAverage` trigger events have been captured.

Each accumulator record has interleaved samples from CH A and CH B. FPGA accumulators are 32-bit wide, so each accumulator value occupies 4 bytes in a buffer. The digitizer transfers multi-byte values in little-endian byte order.

CH A and CH B accumulator records are always transferred to host memory. As a result, the number of bytes per accumulator record is given by:

```
samplesPerRecord * 2 (channels) * 4 (bytes per accumulator sample)
```

The maximum value of `recordsPerAverage` for 8-bit digitizers is 16777215

Note that `recordsPerAverage` does not have to be equal to the number of records per buffer in AutoDMA mode.

Remark

FPGA record averaging is currently supported on the following digitizers:

- AT9870 with FPGA version 180.0 and above, and driver version 5.9.8 and above
- AXI9870 with FPGA version 180.0 and above, and driver version 5.9.23 and above

Note: This function is part of the dual-port API. It should be used only in this context. To abort single-port acquisitions using, see [AlazarAbortCapture\(\)](#).

Parameters

- `handle` – **[in]** Handle to board
- `mode` – **[in]** Averaging mode. Should be one element of [ALAZAR_CRA_MODES](#).
- `samplesPerRecord` – **[in]** The number of ADC samples per accumulator record.
- `recordsPerAverage` – **[in]** The number of records to accumulate per average.
- `options` – **[in]** The averaging options. Can be one of [ALAZAR_CRA_OPTIONS](#).

Returns

[ApiSuccess](#) upon success, or an error code. See [RETURN_CODE](#) for more detailed information.

6.15.2 LabVIEW Block Diagram

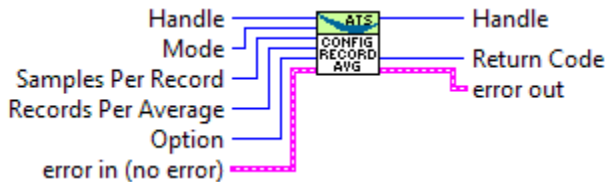

6.15.3 Related Enumerations

enum ALAZAR_CRA_MODES

AlazarConfigureRecordAverage() modes.

Values:

enumerator CRA_MODE_DISABLE

0 Disables record average

enumerator CRA_MODE_ENABLE_FPGA_AVE

1 Enables record average

enum ALAZAR_CRA_OPTIONS

AlazarConfigureRecordAverage() options.

Values:

enumerator CRA_OPTION_UNSIGNED

0U << 1 Unsigned data

enumerator CRA_OPTION_SIGNED

1U << 1 Signed data

6.16 AlazarConfigureSampleSkipping

6.16.1 Function Syntax

RETURN_CODE AlazarConfigureSampleSkipping(HANDLE handle, U32 mode, U32 sampleClocksPerRecord, U16 *sampleSkipBitmap)

Makes the digitizer sub-sample post trigger data in arbitrary, non-uniform intervals.

The application specifies which sample clock edges after a trigger event the digitizer should use to generate sample points, and which sample clock edges the digitizer should ignore.

To enable data skipping, first create a bitmap in memory that specifies which sample clock edges should generate a sample point, and which sample clock edges should be ignored.

- 1's in the bitmap specify the clock edges that should generate a sample point. The total number of 1's in the bitmap must be equal to the number of post-trigger samples per record specified in the call to [AlazarSetRecordSize\(\)](#).
- 0's in the bitmap specify the clock edges that should not be used to generate a sample point.
- The total total number of bits in the bitmap is equal to the number of sample clocks in one record.

For example, to receive 16 samples from 32 sample clocks where every other sample clock is ignored, create a bitmap of 32 bits with values { 1 0 1 0 1 0 ... 1 0 }, or { 0x5555, 0x5555 }. Note that 16 of the 32 bits are 1's.

And to receive 24 samples from 96 sample clocks where data from every 3 of 4 samples clocks is ignored, create a bitmap of 96 bits with values { 1 0 0 0 1 0 0 0 1 0 0 0 ... 1 0 0 0 }, or in { 0x1111, 0x1111, 0x1111, 0x1111, 0x1111, 0x1111 }. Note that 24 of the 96 bits are 1's.

After creating a bitmap, call [AlazarConfigureSampleSkipping\(\)](#) with:

- Mode equal to [SSM_ENABLE](#)
- SampleClocksPerRecord equal to the total number of sample clocks per record.
- pSampleSkipBitmap with the address of the U16 array.

To disable data skipping, call [AlazarConfigureSampleSkipping](#) with Mode equal to [SSM_DISABLE](#). The SampleClocksPerRecord and pSampleSkipBitmap parameters are ignored.

Note that data skipping currently is supported by the ATS9371, ATS9373, ATS9360 and ATS9440. For ATS9440, data skipping only works with post-trigger data acquired at 125 MSPS or 100 MSPS.

Parameters

- handle – **[in]** Handle to board
- mode – **[in]** The data skipping mode. 0 means disable sample skipping and 1 means enable sample skipping.
- sampleClocksPerRecord – **[in]** The number of sample clocks per record. This value cannot exceed 65536.

- `sampleSkipBitmap` – **[in]** An array of bits that specify which sample clock edges should be used to capture a sample point (value = 1) and which should be ignored (value = 0).

Returns

ApiSuccess upon success, or an error code. See *RETURN_CODE* for more detailed information.

6.16.2 LabVIEW Block Diagram

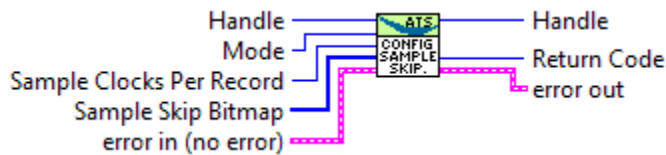

6.16.3 Related Enumerations

enum ALAZAR_SAMPLE_SKIPPING_MODES

Data skipping modes. See *AlazarConfigureSampleSkipping()*

Values:

enumerator SSM_DISABLE

0 Disable sample skipping

enumerator SSM_ENABLE

1 Enable sample skipping

6.17 AlazarCoproprocessorDownload

`AlazarCoproprocessorDownload()` is a define that points to `AlazarCoproprocessorDownloadA()` on Linux and on Windows if `UNICODE` is not defined. If `UNICODE` is defined on Windows, `AlazarCoproprocessorDownload()` points to `AlazarCoproprocessorDownloadW()`. The two functions only vary by the fact that they use narrow or wide string types.

6.17.1 Function Syntax

RETURN_CODE AlazarCoproprocessorDownloadA(HANDLE handle, char *fileName, U32 options)

Downloads a FPGA image in RBF (raw binary file) format to the coprocessor FPGA.

Parameters

- handle – **[in]** Handle to board
- fileName – **[in]** Path to RBF file
- options – **[in]** Download options chosen from [ALAZAR_COPROCESSOR_DOWNLOAD_OPTIONS](#)

Returns

ApiSuccess upon success, or an error code. See [RETURN_CODE](#) for more detailed information.

RETURN_CODE AlazarCoproprocessorDownloadW(HANDLE handle, wchar_t *fileName, U32 options)

Downloads a FPGA image in RBF (raw binary file) format to the coprocessor FPGA.

Parameters

- handle – **[in]** Handle to board
- fileName – **[in]** Path to RBF file
- options – **[in]** Download options chosen from [ALAZAR_COPROCESSOR_DOWNLOAD_OPTIONS](#)

Returns

ApiSuccess upon success, or an error code. See [RETURN_CODE](#) for more detailed information.

6.17.2 LabVIEW Block Diagram

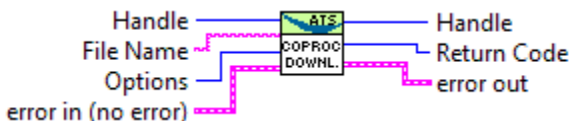

6.17.3 Related Enumerations

enum ALAZAR_COPROCESSOR_DOWNLOAD_OPTIONS

Coprocessor download options.

Values:

enumerator CPF_OPTION_DMA_DOWNLOAD

1

6.18 AlazarCoproprocessorRegisterRead

6.18.1 Function Syntax

RETURN_CODE AlazarCoproprocessorRegisterRead(HANDLE handle, U32 offset, U32 *value)

Reads the content of a user-programmable FPGA register.

Parameters

- handle – **[in]** Handle to board
- offset – **[in]** Register offset
- value – **[out]** Address of a variable to receive the register's value

Returns

ApiSuccess upon success, or an error code. See *RETURN_CODE* for more detailed information.

6.18.2 LabVIEW Block Diagram

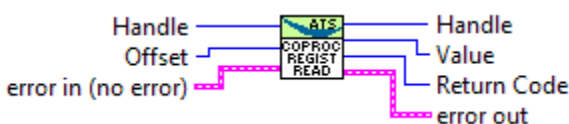

6.19 AlazarCoproprocessorRegisterWrite

6.19.1 Function Syntax

RETURN_CODE AlazarCoproprocessorRegisterWrite(HANDLE handle, U32 offset, U32 value)

Writes a value to a user-programmable coprocessor FPGA register.

Parameters

- handle – **[in]** Handle to board

- offset – **[in]** Register offset
- value – **[in]** Value to write

Returns

ApiSuccess upon success, or an error code. See [RETURN_CODE](#) for more detailed information.

6.19.2 LabVIEW Block Diagram

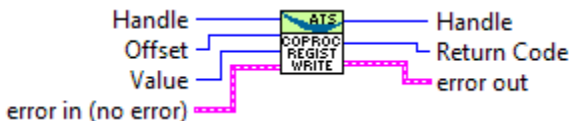

6.20 AlazarCreateStreamFile

`AlazarCreateStreamFile()` is a define that points to `AlazarCreateStreamFileA()` on Linux and on Windows if `UNICODE` is not defined. If `UNICODE` is defined on Windows, `AlazarCreateStreamFile()` points to `AlazarCreateStreamFileW()`. The two functions only vary by the fact that they use narrow or wide string types.

6.20.1 Function Syntax

RETURN_CODE `AlazarCreateStreamFileA(HANDLE handle, const char *filePath)`

Creates a binary data file for this board, and enables saving AutoDMA data from the board to disk.

If possible, select [AlazarBeforeAsyncRead\(\)](#) parameters that result in DMA buffers whose length in bytes is evenly divisible into sectors of the volume selected by `filePath`. If the DMA buffer length is evenly divisible into records, `AlazarCreateStreamFile()` disables file caching to obtain the highest possible sequential write performance.

An AutoDMA buffer is saved to disk when an application calls [AlazarWaitNextAsyncBufferComplete\(\)](#). For best performance, set the `bytesToCopy` parameter in [AlazarWaitNextAsyncBufferComplete\(\)](#) to zero so that data is written to disk without copying it to the user-supplied buffer.

This function must be called after [AlazarBeforeAsyncRead\(\)](#) and before [AlazarStartCapture\(\)](#). File streaming is only active for the acquisition that is about to start when this function is called. You should call this function again for each acquisition with which you want file streaming.

Parameters

- handle – **[in]** Handle to board

- filePath – **[in]** Pointer to a NULL-terminated string that specifies the name of the file.

Returns

ApiSuccess upon success, or an error code. See [RETURN_CODE](#) for more detailed information.

RETURN_CODE AlazarCreateStreamFileW(HANDLE handle, const wchar_t *filePath)

Creates a binary data file for this board, and enables saving AutoDMA data from the board to disk.

If possible, select *AlazarBeforeAsyncRead()* parameters that result in DMA buffers whose length in bytes is evenly divisible into sectors of the volume selected by filePath. If the DMA buffer length is evenly divisible into records, AlazarCreateStreamFile() disables file caching to obtain the highest possible sequential write performance.

An AutoDMA buffer is saved to disk when an application calls *AlazarWaitNextAsyncBufferComplete()*. For best performance, set the bytesToCopy parameter in *AlazarWaitNextAsyncBufferComplete()* to zero so that data is written to disk without copying it to the user-supplied buffer.

This function must be called after *AlazarBeforeAsyncRead()* and before *AlazarStartCapture()*. File streaming is only active for the acquisition that is about to start when this function is called. You should call this function again for each acquisition with which you want file streaming.

Parameters

- handle – **[in]** Handle to board
- filePath – **[in]** Pointer to a NULL-terminated string that specifies the name of the file.

Returns

ApiSuccess upon success, or an error code. See [RETURN_CODE](#) for more detailed information.

6.20.2 LabVIEW Block Diagram

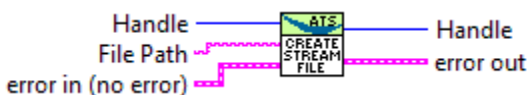

6.21 AlazarDSPAbortCapture

6.21.1 Function Syntax

RETURN_CODE AlazarDSPAbortCapture(HANDLE boardHandle)

Aborts any in-progress DMA transfer, cancels any pending transfers and does DSP-related cleanup.

This function should be called instead of *AlazarAbortAsyncRead()* in a standard acquisition configuration. In addition to handling pending and in-flight DMA transfers, it takes care of some cleanup related to the DSP post-processing.

Warning: Whereas it is not necessary to call *AlazarAbortAsyncRead()* to clean after a standard acquisition, calling *AlazarDSPAbortCapture()* is *strictly required*.

Parameters

- boardHandle – The board to stop the acquisition for.

6.21.2 LabVIEW Block Diagram



6.22 AlazarDSPGenerateWindowFunction

6.22.1 Function Syntax

RETURN_CODE AlazarDSPGenerateWindowFunction(U32 windowType, float *window, U32 windowLength_samples, U32 paddingLength_samples)

Fills an array with a generated window function and pads it with zeros.

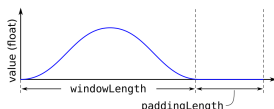

Please note that the windows length can take any integer value. It does not need to meet the alignment requirements that apply to the record length, nor the power-of-two requirement of the FFT length. This can allow users a very high level of control over the effective acquired record length.

For example, if a laser source guarantees 1396 good data points at a particular frequency, the number of samples per record on ATS9360 should be set to 1408 (the next multiple of 128) and the FFT length should be 2048 points. The window function will be generated with a `windowLength_samples` of 1396, and a `paddingLength_samples` of 652 (2048 - 1396).

Remark

Using Python, the window array is not allocated first then passed as an output parameter. Instead, it is directly returned from the function as a newly allocated NumPy array.

Parameters

- `windowType` – Type of window to generate. Pass an item from [DSP_WINDOW_ITEMS](#) enum.
- `window` – Array to be filled with the window function. It must be at least `windowLength_samples` + `paddingLength_samples` long.
- `windowLength_samples` – The size of the window to generate.
- `paddingLength_samples` – The number of samples after the window function to pad with zeros.

Returns

`ApiSuccess` upon success.

6.22.2 Related Enumerations

enum `DSP_WINDOW_ITEMS`

Various types of window functions.

Used by [AlazarDSPGenerateWindowFunction\(\)](#).

Values:

enumerator `DSP_WINDOW_NONE`

0

enumerator `DSP_WINDOW_HANNING`

1

enumerator `DSP_WINDOW_HAMMING`

2

enumerator `DSP_WINDOW_BLACKMAN`

3

enumerator DSP_WINDOW_BLACKMAN_HARRIS

4

enumerator DSP_WINDOW_BARTLETT

5

6.23 AlazarDSPGetBuffer

6.23.1 Function Syntax

RETURN_CODE AlazarDSPGetBuffer(HANDLE boardHandle, void *buffer, U32 timeout_ms)

Waits until a buffer becomes available or an error occurs.

This function should be called instead of [AlazarWaitAsyncBufferComplete\(\)](#) in a standard acquisition configuration.

Parameters

- boardHandle – Board that filled the buffer we want to retrieve
- buffer – Pointer to the DMA buffer we want to retrieve. This must correspond to the first DMA buffer posted to the board that has not yet been retrieved.
- timeout_ms – Time to wait for the buffer to be ready before returning with an ApiWaitTimeout error.

6.23.2 LabVIEW Block Diagram

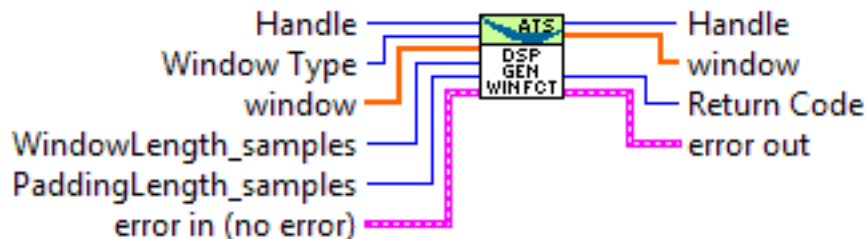

6.24 AlazarDSPGetInfo

6.24.1 Function Syntax

```
RETURN_CODE AlazarDSPGetInfo(dsp_module_handle dspHandle, U32 *dspModuleId, U16
    *versionMajor, U16 *versionMinor, U32 *maxLength,
    U32 *supportedChannels, U32 *reserved1)
```

Get information about a specific On-FPGA DSP implementation.

Use this function to query the type of a DSP module, as well as other information.

Parameters

- dspHandle – The handle to the DSP module to query.
- dspModuleId – The identifier of the DSP module. This describes what the type of this module is, and can be compared against the [DSP_MODULE_TYPE](#) enum.
- versionMajor – The major version number of the DSP implementation.
- versionMinor – The minor version number of the DSP implementation.
- maxLength – The maximum length of the records that can be processed.
- supportedChannels – For [DSP_MODULE_FFT](#) modules, this is a bitmask of the input channels that can be active together with the DSP module. This parameter is ignored for different DSP modules.
- reserved1 – Reserved parameter. Ignored

Returns

ApiSuccess upon success.

6.24.2 LabVIEW Block Diagram

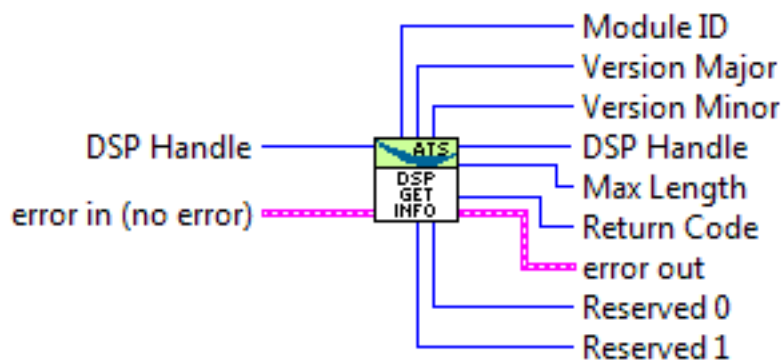

6.24.3 Related Enumerations

enum DSP_MODULE_TYPE

DSP module type.

Used by [AlazarDSPGetInfo\(\)](#).

Values:

enumerator DSP_MODULE_NONE

0xFFFF avoids confusion with internal register.

enumerator DSP_MODULE_FFT

0x10000 FFT multisample

enumerator DSP_MODULE_PCD

0x10001 PC Decoder Averager

enumerator DSP_MODULE_SSK

0x10002 Sample SKipper

enumerator DSP_MODULE_DIS

0x10003 DeInterlacer re-Scaling

6.25 AlazarDSPGetModules

6.25.1 Function Syntax

RETURN_CODE AlazarDSPGetModules(HANDLE boardHandle, U32 numEntries,
dsp_module_handle *modules, U32 *numModules)

Queries the list of DSP modules in a given board.

This function allows to query the list of DSP modules for a digitizer board. `modules` is a pointer to an array of DSP modules to be filled by this function. The `numEntries` parameter specifies how many modules can be added by the function to the `modules` array. Lastly, the `numModules` array specifies how many modules are available on the specified board.

`modules` can be NULL. In this case, the only interest of this function is to return the number of modules available. Please note that `numEntries` must be zero if `modules` is NULL.

`numModules` can be NULL. In this case, it is ignored.

This function is typically called twice. First without a `modules` array to query the number of available modules, and a second time after allocating an appropriate array.

```

U32 numModules;

U32 retCode = AlazarDSPGetModules(handle, 0, NULL, &numModules);

// Error handling

dsp_module_handle modules[numModules];

retCode = AlazarDSPGetModules(handle, numModules, modules, NULL);

// Error handling
    
```

Parameters

- boardHandle – The handle of the board to query DSP modules for.
- numEntries – The maximum number of entries that the function can fill in the modules array. Must be zero if modules is NULL.
- modules – The array where this function fills the dsp_module_handle elements. Can be NULL.
- numModules – Returns the number of DSP modules available on this board. Ignored if NULL.

Returns

ApiSuccess upon success.

6.25.2 LabVIEW Block Diagram

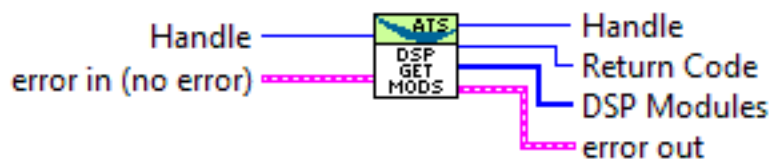

6.26 AlazarDSPGetNextBuffer

6.26.1 Function Syntax

RETURN_CODE AlazarDSPGetNextBuffer(HANDLE boardHandle, void *buffer, U32 bytesToCopy, U32 timeout_ms)

Equivalent of [AlazarDSPGetBuffer\(\)](#) to call with [ADMA_ALLOC_BUFFERS](#).

This function should be called instead of [AlazarWaitNextAsyncBufferComplete\(\)](#) in a standard acquisition configuration. See the documentation of this function for more information.

Parameters

- boardHandle – Board that filled the buffer we want to retrieve
- buffer – Pointer to a buffer to receive sample data from the digitizer board.
- bytesToCopy – The number of bytes to copy into the buffer.
- timeout_ms – Time to wait for the buffer to be ready before returning with an ApiWaitTimeout error.

6.26.2 LabVIEW Block Diagram

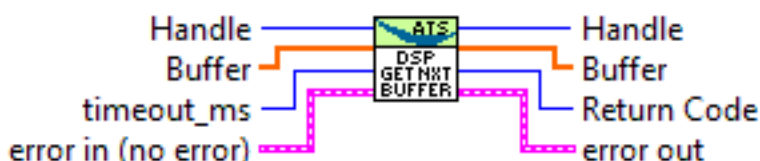

6.27 AlazarDSPGetParameterFloat

6.27.1 Function Syntax

RETURN_CODE AlazarDSPGetParameterFloat(dsp_module_handle dspHandle, U32 parameter, float *result)

Generic interface to retrieve Float-typed parameters.

This function is called with an element of *DSP_PARAMETERS_FLOAT* as parameter. Depending on which value is selected, the function will query a different parameter internally and pass the return value to *result*.

This function returns *ApiSuccess* upon success, and standard errors otherwise.

6.27.2 LabVIEW Block Diagram



6.27.3 Related Enumerations

enum DSP_PARAMETERS_FLOAT

Parameters that can be queried with `AlazarDSPGetParameter*()` or set with `AlazarDSPSetParameter*()`

See [AlazarDSPGetParameterFloat\(\)](#) and [AlazarDSPSetParameterFloat\(\)](#) for information about the way to use these parameters.

Values:

6.28 AlazarDSPGetParameterS32

6.28.1 Function Syntax

RETURN_CODE `AlazarDSPGetParameterS32(dsp_module_handle dspHandle, U32 parameter, S32 *result)`

Generic interface to retrieve S32-typed parameters.

This function is called with an element of [DSP_PARAMETERS_S32](#) as parameter. Depending on which value is selected, the function will query a different parameter internally and pass the return value to `result`.

This function returns `ApiSuccess` upon success, and standard errors otherwise.

6.28.2 LabVIEW Block Diagram



6.28.3 Related Enumerations

enum DSP_PARAMETERS_S32

Parameters that can be queried with `AlazarDSPGetParameter*()` or set with `AlazarDSPSetParameter*()`

See [AlazarDSPGetParameterS32\(\)](#) and [AlazarDSPSetParameterS32\(\)](#) for information about the way to use these parameters.

Values:

6.29 AlazarDSPGetParameterU32

6.29.1 Function Syntax

RETURN_CODE AlazarDSPGetParameterU32(dsp_module_handle dspHandle, U32 parameter, U32 *result)

Generic interface to retrieve U32-typed parameters.

This function is called with an element of *DSP_PARAMETERS_U32* as parameter. Depending on which value is selected, the function will query a different parameter internally and pass the return value to *result*.

This function returns *ApiSuccess* upon success, and standard errors otherwise.

6.29.2 LabVIEW Block Diagram



6.29.3 Related Enumerations

enum DSP_PARAMETERS_U32

Parameters that can be queried with AlazarDSPGetParameter*()

See [AlazarDSPGetParameterU32\(\)](#) for information about the way to use these parameters.

Values:

enumerator DSP_RAW_PLUS_FFT_SUPPORTED

0 Tells if an FFT module supports RAW+FFT mode. This parameter returns 0 if RAW+FFT mode is not supported, and 1 if it is.

enumerator DSP_FFT_SUBTRACTOR_SUPPORTED

1 Tells if an FFT module supports the background subtraction feature. This parameter returns 0 if the feature is not supported, and 1 if it is.

enumerator DSP_FFT_GAIN_OFFSET_SUPPORTED

2 Tells if an FFT module supports setting the gain and offset feature. This parameter returns 0 if the feature is not supported, and 1 if it is.

6.30 AlazarDSPSetParameterFloat

6.30.1 Function Syntax

RETURN_CODE AlazarDSPSetParameterFloat(dsp_module_handle dspHandle, U32 parameter, float value)

Generic interface to set Float-typed parameters.

This function is called with an element of *DSP_PARAMETERS_FLOAT* as parameter. Depending on which value is selected, the function will write value to different parameter internally.

This function returns ApiSuccess upon success, and standard errors otherwise.

6.30.2 LabVIEW Block Diagram

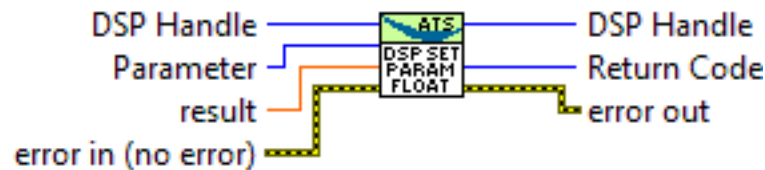

6.31 AlazarDSPSetParameterS32

6.31.1 Function Syntax

RETURN_CODE AlazarDSPSetParameterS32(dsp_module_handle dspHandle, U32 parameter, S32 value)

Generic interface to set S32-typed parameters.

This function is called with an element of *DSP_PARAMETERS_S32* as parameter. Depending on which value is selected, the function will write value to different parameter internally.

This function returns ApiSuccess upon success, and standard errors otherwise.

6.31.2 LabVIEW Block Diagram

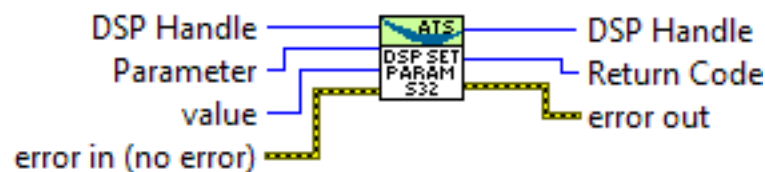

6.32 AlazarDSPSetParameterU32

6.32.1 Function Syntax

RETURN_CODE AlazarDSPSetParameterU32(dsp_module_handle dspHandle, U32 parameter, U32 value)

Generic interface to set U32-typed parameters.

This function is called with an element of *DSP_PARAMETERS_U32* as parameter. Depending on which value is selected, the function will write value to different parameter internally.

This function returns ApiSuccess upon success, and standard errors otherwise.

6.32.2 LabVIEW Block Diagram

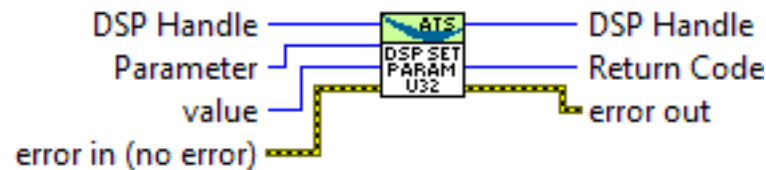

6.33 AlazarErrorToText

6.33.1 Function Syntax

const char *AlazarErrorToText(*RETURN_CODE* retCode)

Converts a numerical return code to a NULL terminated string.

Remark

It is often easier to work with a descriptive error name than an error number.

Parameters

- retCode – **[in]** Return code from an AlazarTech API function

Returns

A string containing the identifier name of the error code

6.33.2 LabVIEW Block Diagram



6.33.3 Related Enumerations

enum RETURN_CODE

API functions return codes.

Values:

enumerator ApiSuccess

512 The operation completed without error

enumerator ApiFailed

513 The operation failed

enumerator ApiAccessDenied

514 Access denied

enumerator ApiDmaChannelUnavailable

515 Channel selection is unavailable

enumerator ApiDmaChannelInvalid

516 Channel selection in invalid

enumerator ApiDmaChannelTypeError

517 Channel selection is invalid

enumerator ApiDmaInProgress

518 A data transfer is in progress. This error code indicates that the current action cannot be performed while an acquisition is in progress. It also returned by [AlazarPostAsyncBuffer\(\)](#) if this function is called with an invalid DMA buffer.

enumerator ApiDmaDone

519 DMA transfer is finished

enumerator ApiDmaPaused

520 DMA transfer was paused

enumerator `ApiDmaNotPaused`

521 DMA transfer is not paused

enumerator `ApiDmaCommandInvalid`

522 A DMA command is invalid

enumerator `ApiNullParam`

531 One of the parameters of the function is NULL and should not be

enumerator `ApiUnsupportedFunction`

533 This function is not supported by the API. Consult the manual for more information.

enumerator `ApiInvalidPciSpace`

534 Invalid PCI space

enumerator `ApiInvalidIopSpace`

535 Invalid IOP space

enumerator `ApiInvalidSize`

536 Invalid size passed as argument to the function

enumerator `ApiInvalidAddress`

537 Invalid address

enumerator `ApiInvalidAccessType`

538 Invalid access type requested

enumerator `ApiInvalidIndex`

539 Invalid index

enumerator `ApiInvalidRegister`

543 Invalid register

enumerator `ApiConfigAccessFailed`

550 Access for configuration failed

enumerator `ApiInvalidDeviceInfo`

551 Invalid device information

enumerator `ApiNoActiveDriver`

552 No active driver for the board. Please ensure that a driver is installed

enumerator `ApiInsufficientResources`

553 There were not enough system resources to complete this operation. The most common reason of this return code is using too many DMA buffers, or using DMA buffers that are too big. Please try reducing the number of buffers posted to the board at any time, and/or try reducing the DMA buffer sizes.

enumerator `ApiNotInitialized`

556 The API has not been properly initialized for this function call. Please review one of the code samples from the ATS-SDK to confirm that API calls are made in the right order.

enumerator `ApiInvalidPowerState`

558 Power state requested is not valid

enumerator `ApiPowerDown`

559 The operation cannot be completed because the device is powered down. For example, this error code is output if the computer enters hibernation while an acquisition is running.

enumerator `ApiNotSupportThisChannel`

561 The API call is not valid with this channel selection.

enumerator `ApiNoAction`

562 The function has requested no action to be taken

enumerator `ApiHSNotSupported`

563 HotSwap is not supported

enumerator `ApiVpdNotEnabled`

565 Vital product data not enabled

enumerator `ApiInvalidOffset`

567 Offset argument is not valid

enumerator `ApiPciTimeout`

569 Timeout on the PCI bus

enumerator `ApiInvalidHandle`

572 Invalid handle passed as argument

enumerator `ApiBufferNotReady`

573 The buffer passed as argument is not ready to be called with this API. This error code is most often seen is the order of buffers posted to the board is not respected when querying them.

enumerator `ApiInvalidData`

574 Generic invalid parameter error. Check the function's documentation for more information about valid argument values.

enumerator `ApiDoNothing`

575

enumerator `ApiDmaSglBuildFailed`

576 Unable to lock buffer and build SGL list

enumerator `ApiPMNotSupported`

577 Power management is not supported

enumerator `ApiInvalidDriverVersion`

578 Invalid driver version

enumerator `ApiWaitTimeout`

579 The operation did not finish during the timeout interval. try the operation again, or abort the acquisition.

enumerator `ApiWaitCanceled`

580 The operation was cancelled.

enumerator `ApiBufferTooSmall`

581 The buffer used is too small. Try increasing the buffer size.

enumerator `ApiBufferOverflow`

582 The board overflowed its internal (on-board) memory. Try reducing the sample rate, reducing the number of enabled channels. Also ensure that DMA buffer size is between 1 MB and 8 MB.

enumerator `ApiInvalidBuffer`

583 The buffer passed as argument is not valid.

enumerator `ApiInvalidRecordsPerBuffer`

584 The number of records per buffer passed as argument is invalid.

enumerator `ApiDmaPending`

585 An asynchronous I/O operation was successfully started on the board. It will be completed when sufficient trigger events are supplied to the board to fill the buffer.

enumerator `ApiLockAndProbePagesFailed`

586 The buffer is too large for the driver or operating system to prepare for scatter-gather DMA transfer. Try reducing the size of each buffer, or reducing the number of buffers queued by the application.

enumerator `ApiTransferComplete`

589 This buffer is the last in the current acquisition

enumerator `ApiPllNotLocked`

590 The on-board PLL circuit could not lock. If the acquisition used an internal sample clock, this might be a symptom of a hardware problem; contact AlazarTech. If the acquisition used an external 10 MHz PLL signal, please make sure that the signal is fed in properly.

enumerator `ApiNotSupportedInDualChannelMode`

591 The requested acquisition is not possible with two channels. This can be due to the sample rate being too fast for DES boards, or to the number of samples per record being too large. Try reducing the number of samples per channel, or switching to single channel mode.

enumerator `ApiNotSupportedInQuadChannelMode`

592 The requested acquisition is not possible with four channels. This can be due to the sample rate being too fast for DES boards, or to the number of samples per record being too large. Try reducing the number of samples per channel, or switching to single channel mode.

enumerator `ApiFileIoError`

593 A file read or write error occurred.

enumerator `ApiInvalidClockFrequency`

594 The requested ADC clock frequency is not supported.

enumerator `ApiInvalidSkipTable`

595 Invalid skip table passed as argument

enumerator `ApiInvalidDspModule`

596 This DSP module is not valid for the current operation.

enumerator `ApiDESOnlySupportedInSingleChannelMode`

597 Dual-edge sampling mode is only supported in signal-channel mode. Try disabling dual-edge sampling (lowering the sample rate if using internal clock), or selecting only one channel.

enumerator `ApiInconsistentChannel`

598 Successive API calls of the same acquisition have received inconsistent acquisition channel masks.

enumerator `ApiDspFiniteRecordsPerAcquisition`

599 DSP acquisition was run with a finite number of records per acquisition. Set this value to infinite.

enumerator `ApiNotEnoughNptFooters`

600 Not enough NPT footers in the buffer for extraction

enumerator `ApiInvalidNptFooter`

601 Invalid NPT footer found

enumerator `ApiOCTIgnoreBadClockNotSupported`

602 OCT ignore bad clock is not supported

enumerator `ApiError1`

603 The requested number of records in a single-port acquisition exceeds the maximum supported by the digitizer. Use dual-ported AutoDMA to acquire more records per acquisition.

enumerator `ApiError2`

604 The requested number of records in a single-port acquisition exceeds the maximum supported by the digitizer.

enumerator `ApiOCTNoTriggerDetected`

605 No trigger is detected as part of the OCT ignore bad clock feature.

enumerator `ApiOCTTriggerTooFast`

606 Trigger detected is too fast for the OCT ignore bad clock feature.

enumerator `ApiNetworkError`

607 There was a network-related issue. Make sure that the network connection and settings are correct.

enumerator `ApiFftSizeTooLarge`

608 On-FPGA FFT cannot support FFT that large. Try reducing the FFT size, or querying the maximum FFT size with [AlazarDSPGetInfo\(\)](#)

enumerator `ApiGPUError`

609 GPU returned an error. See log for more information

enumerator `ApiAcquisitionModeOnlySupportedInFifoStreaming`

610 This board only supports this acquisition mode in FIFO only streaming mode. Please set the [ADMA_FIFO_ONLY_STREAMING](#) flag in [AlazarBeforeAsyncRead\(\)](#).

enumerator `ApiInterleaveNotSupportedInTraditionalMode`

611 This board does not support sample interleaving in traditional acquisition mode. Please refer to the SDK guide for more information.

enumerator `ApiRecordHeadersNotSupported`

612 This board does not support record headers. Please refer to the SDK guide for more information.

enumerator `ApiRecordFootersNotSupported`

613 This board does not support record footers. Please refer to the SDK guide for more information.

enumerator `ApiFastBufferLockCountExceeded`

614 The number of different DMA buffers posted exceeds the limit set with [AlazarConfigureFastBufferLock\(\)](#). Either disable fast buffer locking, or confirm that the value passed to [AlazarConfigureFastBufferLock\(\)](#) is respected.

enumerator `ApiInvalidStateDoRetry`

615 The operation could not complete because the system is in an invalid state. You may safely retry the call that returned this error.

enumerator `ApiInvalidInputRange`

616 The operation could not complete because the system is in an invalid state. You may safely retry the call that returned this error.

enumerator `ApiBusy`

617 The operation could not complete because the system is in a busy state. You may safely retry the call that returned this error.

enumerator `ApiNoRcPathVariable`

618 Under Linux, `ATSApi` looks for an `ALAZARRCPATH` or a `HOME` environment variable

to know where to store the .alazarrc configuration file. This error indicates that none of these variables were identified.

enumerator ApiOnFpgaFftOptionMissing

619 This board requires an option to be active to perform on-FPGA FFTs.

enumerator ApiReferenceClockPllNotLocked

620 The PLL of the reference clock was not locked.

enumerator ApiAdcJesdPllNotLocked

621 The JESD link PLL on ADC is not locked.

enumerator ApiAdcJesdLinkNotLocked

622 The JESD link on ADC is not locked.

enumerator ApiFpgaJesdLinkNotLocked

623 The JESD link on FPGA is not locked.

enumerator ApiInvalidFirmwareForATS9364

624 The library does not support FPGA versions under 4.07 for ATS9364. Firmware must be updated.

enumerator ApiHardwareRemoved

625 The hardware is no longer detected in the system.

enumerator ApiInvalidFirmwareForATS4001

626 The library does not support FPGA versions under 6.0 for ATS4001. Firmware must be updated.

enumerator ApiInvalidLicense

627 Invalid license for running the desired software.

6.34 AlazarExtractFFTNPTFooters

6.34.1 Function Syntax

RETURN_CODE AlazarExtractFFTNPTFooters(void *buffer, U32 recordSize_bytes, U32 bufferSize_bytes, NPTFooter *footersArray, U32 numFootersToExtract)

Extracts NPT footers from a buffer acquired during an FFT acquisition.

Before calling this function, it is important to make sure that the buffers have been acquired in NPT mode with the NPT footers active. In addition, the acquisition *must* have used on-FPGA FFT computation.

Warning: This function has been deprecated. NPT footer extraction has been moved to a separate, open-source library. This external library is available at <https://github.com/alazartech/ats-footers>.

Warning: footersArray must contain at least numFootersToExtract elements.

Parameters

- buffer – **[in]** Base address of the DMA buffer to process
- recordSize_bytes – **[in]** Bytes per record in the DMA buffer passed as argument as returned by *AlazarFFTSetup()*.
- bufferSize_bytes – **[in]** Bytes per buffer in the DMA buffer passed as argument
- footersArray – **[out]** Base address of an array of NPTFooter structures which will be filled by this function
- numFootersToExtract – **[in]** Maximum numbers of footers to extract. This can be a number from zero to the number of records in the DMA buffer passed as argument.

6.35 AlazarExtractNPTFooters

6.35.1 Function Syntax

RETURN_CODE AlazarExtractNPTFooters(void *buffer, U32 recordSize_bytes, U32 bufferSize_bytes, NPTFooter *footersArray, U32 numFootersToExtract)

Extracts NPT footers from a buffer that contains them.

Before calling this function, it is important to make sure that the buffers have been acquired in NPT mode with the NPT footers active.

Warning: This function has been deprecated. NPT footer extraction has been moved to a separate, open-source library. This external library is available at <https://github.com/alazartech/ats-footers>.

Warning: footersArray must contain at least numFootersToExtract elements.

Parameters

- buffer – **[in]** Base address of the DMA buffer to process
- recordSize_bytes – **[in]** Bytes per record in the DMA buffer passed as argument
- bufferSize_bytes – **[in]** Bytes per buffer in the DMA buffer passed as argument
- footersArray – **[out]** Base address of an array of NPTFooter structures which will be filled by this function
- numFootersToExtract – **[in]** Maximum numbers of footers to extract. This can be a number from zero to the number of records in the DMA buffer passed as argument.

6.35.2 Related Enumerations

struct _NPTFooter

NPT Footer structure that can be retrieved using [AlazarExtractNPTFooters\(\)](#).

Public Members

U64 triggerTimestamp

Timestamp of the trigger event in this

U32 recordNumber

acquisition.

Record number

U32 frameCount

Frame count.

BOOL aux_in_state

AUX I/O state received during the record's acquisition

6.36 AlazarExtractTimeDomainNPTFooters

6.36.1 Function Syntax

RETURN_CODE AlazarExtractTimeDomainNPTFooters(void *buffer, U32 recordSize_bytes, U32 bufferSize_bytes, NPTFooter *footersArray, U32 numFootersToExtract)

Extracts NPT footers from a buffer acquired during a time-domain acquisition.

Before calling this function, it is important to make sure that the buffers have been acquired in NPT mode with the NPT footers active. In addition, the acquisition must *not* have used on-FPGA FFT computation.

Warning: This function has been deprecated. NPT footer extraction has been moved to a separate, open-source library. This external library is available at <https://github.com/alazartech/ats-footers>.

Warning: footersArray must contain at least numFootersToExtract elements.

Parameters

- buffer – **[in]** Base address of the DMA buffer to process
- recordSize_bytes – **[in]** Bytes per record in the DMA buffer passed as argument
- bufferSize_bytes – **[in]** Bytes per buffer in the DMA buffer passed as argument
- footersArray – **[out]** Base address of an array of NPTFooter structures which will be filled by this function
- numFootersToExtract – **[in]** Maximum numbers of footers to extract. This can be a number from zero to the number of records in the DMA buffer passed as argument.

6.37 AlazarFFTBackgroundSubtractionGetRecordS16

6.37.1 Function Syntax

RETURN_CODE AlazarFFTBackgroundSubtractionGetRecordS16(dsp_module_handle dspHandle, S16 *backgroundRecord, U32 size_samples)

Reads the background subtraction record from a board.

This function can be called to read which record the board uses for the background subtraction feature. It is used by allocating an array of the right size, then passing it to backgroundRecord along with it's size in samples to size_samples.

This function should be called before or between acquisitions, not during one.

6.37.2 LabVIEW Block Diagram



6.38 AlazarFFTBackgroundSubtractionSetEnabled

6.38.1 Function Syntax

RETURN_CODE AlazarFFTBackgroundSubtractionSetEnabled(dsp_module_handle dspHandle, BOOL enabled)

Controls the activation of the background subtraction feature.

Passing true to enabled activates background subtraction. Passing false deactivates it.

This function should be called before or between acquisitions, not during one.

6.38.2 LabVIEW Block Diagram

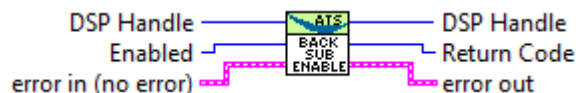

6.39 AlazarFFTBackgroundSubtractionSetRecordS16

6.39.1 Function Syntax

RETURN_CODE AlazarFFTBackgroundSubtractionSetRecordS16(dsp_module_handle dspHandle, const S16 *record, U32 size_samples)

Download the record for the background subtraction feature to a board.

Pass this function a pointer to an 16-bit integer array containing the record you want to download, and the size of this record in samples.

This function should be called before or between acquisitions, not during one.

6.39.2 LabVIEW Block Diagram



6.40 AlazarFFTGetMaxTriggerRepeatRate

6.40.1 Function Syntax

RETURN_CODE AlazarFFTGetMaxTriggerRepeatRate(dsp_module_handle dspHandle, U32 fftSize, double *maxTriggerRepeatRate)

Queries the maximum trigger repeat rate that the FFT engine can support without overflow.

This utility function is useful to calculate the theoretical maximum speed at which FFTs can be computed on a specific digitizer. The value returned only takes into account the FFT processing speed of the on-board module. Other parameters such as bus transfer speed must still be taken into account to ensure that an acquisition is possible on a given board.

Note: Using Raw + FFT reduces the maximum speed at which FFTs can be processed. The value returned by this function is valid without raw + FFT only.

Warning: This function is available for FFT modules versions 4.5 and up.

Parameters

- `dspHandle` – **[in]** The board for which to calculate the maximum trigger rate.
- `fftSize` – **[in]** The number of points acquired by the board per FFT operation.
- `maxTriggerRepeatRate` – **[out]** Output parameter that gets assigned the maximum trigger rate supported by this board's FFT processing module in Hertz.

Returns

`ApiSuccess` upon success

Returns

`ApiInvalidDspModule` if the FFT module is invalid (wrong type or version)

6.40.2 LabVIEW Block Diagram

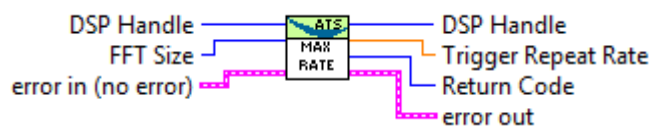

6.41 AlazarFFTSetGainAndOffset

6.41.1 Function Syntax

RETURN_CODE `AlazarFFTSetGainAndOffset(dsp_module_handle dspHandle, float gain, float offset)`

Set the gain and offset for log U16 and log U8 outputs.

Remark

This function is only valid for a limited number of datapaths. Use [AlazarDSPGetParameterU32\(\)](#) with parameter `DSP_FFT_GAIN_OFFSET_SUPPORTED` to see if function is supported.

Warning: On ATS9373 and ATS9371, this function is intended to be used for log U8 and log U16 outputs. Using it with other FFT outputs will result in undefined behaviors.

Warning: This function should not be used with [AlazarFFTSetScalingAndSlicing\(\)](#). Using both will result in undefined behaviors.

Parameters

- dspHandle – Handle to DSP module
- gain – Gain to be applied to output.
- offset – Offset to be applied to output.

6.41.2 LabVIEW Block Diagram

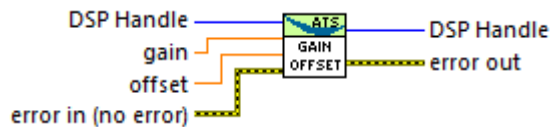

6.42 AlazarFFTSetScalingAndSlicing

6.42.1 Function Syntax

RETURN_CODE AlazarFFTSetScalingAndSlicing(dsp_module_handle dspHandle, U8 slice_pos, float loge_ampl_mult)

Sets internal scaling and slicing parameters in the FFT module.

This function modifies internal parameters used by the on-FPGA FFT module to convert the output of the FFT engine to the desired format. Please refer to the figure below for details as to where conversions happen.

Remark

This function is only valid for on-FPGA FFT modules with version *less than 5*.

Standard FFT algorithms use floating point precision to obtain frequency domain data, which is not the case with the on-FPGA FFT module. A re-scaling of the standard FFT data must be done to obtain corresponding onFPGA data:

```
FPGA_LINEAR_AMP^2 = (REAL^2 + IMAG^2) / SLICE_FACTOR;
FPGA_LOG = loge_ampl_mult * ln((REAL^2 + IMAG^2)/256);
FPGA_REAL = REAL / 16;
FPGA_IMAG = IMAG / 16;
```

Where **REAL** and **IMAG** are the real and imaginary parts of the standard FFT algorithm. **loge_ampl_mult** is the value passed as argument. The SLICE_FACTOR value depends on the output format such as:

- U8 format: SLICE_FACTOR = 2^(slice_pos + 1);
- U16 format: SLICE_FACTOR = 2^(slice_pos - 7);
- U32 format: SLICE_FACTOR = 2^(slice_pos - 23);
- Float format: SLICE_FACTOR = 256;

To use this function in your program, it is necessary to call it **after** *AlazarFFTSetup()*, because this is where default scaling and slicing values are set.

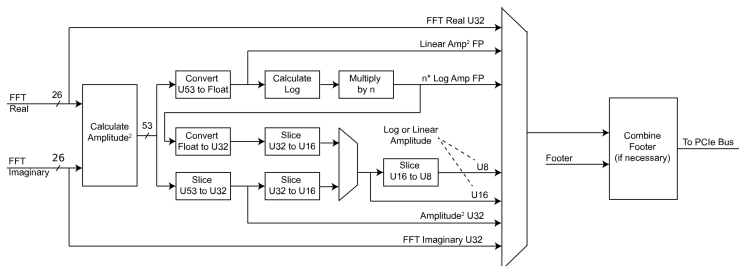

Warning: This function is intended for advanced users only. Calling it with the wrong parameters can prevent any meaningful data from being output by the FFT module.

Warning: This function should not be used with *AlazarFFTSetGainAndOffset()*. Using both will result in undefined behaviors.

Parameters

- dspHandle – Handle to DSP module
- slice_pos – This parameter indicates the position of the most significant bit of the output of slicing operations with respect to the input. Lowering this value by one has the effect of multiplying the output of the FFT module by 2. Default value is 7 for log outputs and 38 otherwise. On the block diagram, this parameter applies to all blocks marked ‘Slice’.
- loge_ampl_mult – This controls a multiplicative factor used after the log conversion in the FFT module. Hence, it does not apply to ‘amplitude squared’ outputs. Default value is 4.3429446 for U8 and float log outputs, and 1111.7938176 for U16 log output.

6.42.2 LabVIEW Block Diagram

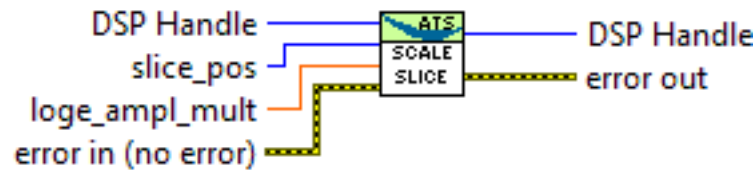

6.43 AlazarFFTSetWindowFunction

6.43.1 Function Syntax

RETURN_CODE AlazarFFTSetWindowFunction(dsp_module_handle dspHandle, U32 samplesPerRecord, float *realWindowArray, float *imagWindowArray)

Sets the window function to use with an on-FPGA FFT module.

Downloads a window function to an AlazarTech digitizer's memory. This window function will be used during all subsequent acquisitions that use the on-FPGA DSP module.

This function should be called before *AlazarFFTSetup()*. It does not have to be called every time an acquisition is done. It can be located in the board configuration section.

Warning: Please note that the window function is not compatible with the FFT verification mode.

Parameters

- *dspHandle* – The handle of the FFT DSP module to set the window function for.
- *samplesPerRecord* – The number of samples in the window function array.
- *realWindowArray* – The real window function array. Passing NULL is equivalent to passing an array filled with ones. The values of the window function must be in the interval [-1, 1].
- *imagWindowArray* – The imaginary window function array. Passing NULL is equivalent to passing an array filled with zeros. The values of the window function must be in the interval [-1, 1].

6.43.2 LabVIEW Block Diagram

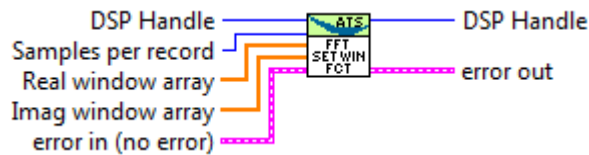

6.44 AlazarFFTSetup

6.44.1 Function Syntax

```
RETURN_CODE AlazarFFTSetup(dsp_module_handle dspHandle, U16 inputChannelMask,
                             U32 recordLength_samples, U32 fftLength_samples, U32
                             outputFormat, U32 footer, U32 reserved, U32
                             *bytesPerOutputRecord)
```

Configure the board for an FFT acquisition.

This function needs to be called in the board configuration procedure, therefore before [AlazarBeforeAsyncRead\(\)](#).

The output format of the fft is controlled by the `outputFormat` parameter, with the [FFT_OUTPUT_FORMAT](#) enumeration. All elements of [FFT_OUTPUT_FORMAT](#) except `FFT_OUTPUT_FORMAT_RAW_PLUS_FFT` describe a data type (unsigned 8-bit integer, floating point number, etc.) as well as a scale (logarithmic or amplitude squared). It is mandatory to select one (and only one) of these.

On the other hand, when `FFT_OUTPUT_FORMAT_RAW_PLUS_FFT` is OR'ed (using the `C |` operator) to another symbol, it has the meaning of asking the board to output both the time-domain (raw) and FFT data.

Parameters

- `dspHandle` – The FFT module to configure.
- `inputChannelMask` – The channels to acquire data from. This must be [CHANNEL_A](#).
- `recordLength_samples` – The number of points per record to acquire. This needs to meet the usual requirements for the number of samples per record. Please see the documentation of [AlazarBeforeAsyncRead\(\)](#) for more information.
- `fftLength_samples` – The number of points per FFT. This value must be:
 - A power of two;
 - Greater than or equal to `recordLength_samples`;

- Less than or equal to the maximum FFT size, as returned by the *AlazarDSPGetInfo()* function.
- `outputFormat` – Describes what data is output from the FFT post-processing module. This can be any element of the *FFT_OUTPUT_FORMAT* enum, optionally OR'ed with one or more element from *FFT_OUTPUT_FORMAT_OPTION*.
- `footer` – Describes if a footer is attached to the returned records. Must be an element of the *FFT_FOOTER* enum.
- `reserved` – Reserved for future use. Pass 0.
- `bytesPerOutputRecord` – Returns the number of bytes in each record coming out of the FFT module. This value can be used to know how long the allocated DMA buffers must be.

6.44.2 LabVIEW Block Diagram

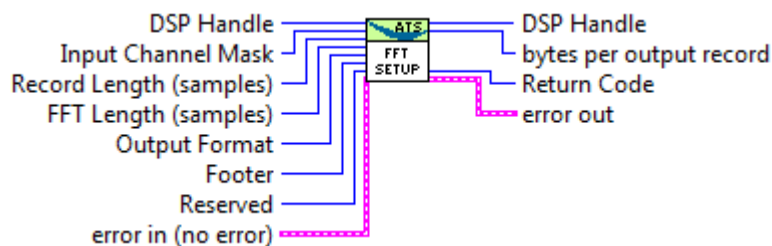

6.44.3 Related Enumerations

enum `FFT_OUTPUT_FORMAT`

FFT output format enumeration.

Values:

enumerator `FFT_OUTPUT_FORMAT_U32_AMP2`

0x0 32-bit unsigned integer amplitude squared output.

enumerator `FFT_OUTPUT_FORMAT_U16_LOG`

0x1 16-bit unsigned integer logarithmic amplitude output.

enumerator `FFT_OUTPUT_FORMAT_U16_AMP2`

0x101 16-bit unsigned integer amplitude squared output.

enumerator `FFT_OUTPUT_FORMAT_U8_LOG`

0x2 8-bit unsigned integer logarithmic amplitude output.

enumerator FFT_OUTPUT_FORMAT_U8_AMP2
0x102 8-bit unsigned integer amplitude squared output.

enumerator FFT_OUTPUT_FORMAT_S32_REAL
0x3 32-bit signed integer real part of FFT output.

enumerator FFT_OUTPUT_FORMAT_S32_IMAG
0x4 32-bit signed integer imaginary part of FFT output.

enumerator FFT_OUTPUT_FORMAT_FLOAT_AMP2
0xA 32-bit floating point amplitude squared output.

enumerator FFT_OUTPUT_FORMAT_FLOAT_LOG
0xB 32-bit floating point logarithmic output.

enumerator FFT_OUTPUT_FORMAT_U16_AMP
0xC 16-bit amplitude output

enum FFT_FOOTER
FFT footer enumeration.

Values:

enumerator FFT_FOOTER_NONE
0x0

enumerator FFT_FOOTER_NPT
0x1

6.45 AlazarForceTrigger

6.45.1 Function Syntax

RETURN_CODE AlazarForceTrigger(HANDLE handle)
Generate a software trigger event.

Parameters

- handle – **[in]** Board handle

Returns

ApiSuccess upon success, or an error code. See *RETURN_CODE* for more detailed information.

6.45.2 LabVIEW Block Diagram

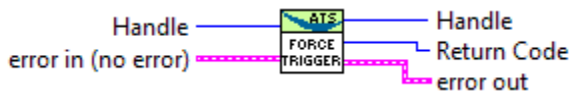

6.46 AlazarForceTriggerEnable

6.46.1 Function Syntax

RETURN_CODE AlazarForceTriggerEnable(HANDLE handle)

Generate a software trigger enable event.

Parameters

- handle – **[in]** Board handle

Returns

ApiSuccess upon success, or an error code. See *RETURN_CODE* for more detailed information.

6.46.2 LabVIEW Block Diagram

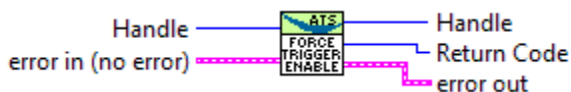

6.47 AlazarFreeBufferU16

6.47.1 Function Syntax

RETURN_CODE AlazarFreeBufferU16(HANDLE handle, U16 *buffer)

Frees a buffer allocated with *AlazarAllocBufferU16()*

Parameters

- handle – **[in]** Handle to board
- buffer – **[in]** Base address of the buffer to free

Returns

ApiSuccess upon success, or an error code. See *RETURN_CODE* for more detailed information.

6.48 AlazarFreeBufferU16Ex

6.48.1 Function Syntax

RETURN_CODE AlazarFreeBufferU16Ex(HANDLE handle, U16 *buffer)

Frees a buffer allocated with *AlazarAllocBufferU16Ex()*

Parameters

- handle – **[in]** Handle to board
- buffer – **[in]** Base address of the buffer to free

Returns

ApiSuccess upon success, or an error code. See *RETURN_CODE* for more detailed information.

6.49 AlazarFreeBufferU8

6.49.1 Function Syntax

RETURN_CODE AlazarFreeBufferU8(HANDLE handle, U8 *buffer)

Frees a buffer allocated with *AlazarAllocBufferU8()*

Parameters

- handle – **[in]** Handle to board
- buffer – **[in]** Base address of the buffer to free

Returns

ApiSuccess upon success, or an error code. See *RETURN_CODE* for more detailed information.

6.50 AlazarFreeBufferU8Ex

6.50.1 Function Syntax

RETURN_CODE AlazarFreeBufferU8Ex(HANDLE handle, U8 *buffer)

Frees a buffer allocated with *AlazarAllocBufferU8Ex()*

Parameters

- handle – **[in]** Handle to board
- buffer – **[in]** Base address of the buffer to free

Returns

ApiSuccess upon success, or an error code. See *RETURN_CODE* for more detailed information.

6.51 AlazarGetBoardBySystemHandle

6.51.1 Function Syntax

HANDLE AlazarGetBoardBySystemHandle(HANDLE systemHandle, U32 boardId)

Get a handle to a board in a board system where the board system is specified by a handle to its master board and the board by its identifier within the system.

Parameters

- systemHandle – **[in]** Handle to master board
- boardId – **[in]** Board identifier in the board system

Returns

A handle to the specified board if it was found

Returns

NULL if the master board handle is invalid, or a board with the specified board identifier was not found in the specified board system.

6.51.2 LabVIEW Block Diagram

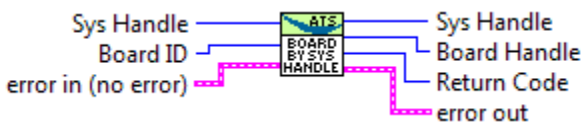

6.52 AlazarGetBoardBySystemID

6.52.1 Function Syntax

HANDLE AlazarGetBoardBySystemID(U32 systemId, U32 boardId)

Get a handle to a board in a board system where the board and system are identified by their ID.

Detailed description

Parameters

- systemId – **[in]** The system identifier
- boardId – **[in]** The board identifier

Returns

A handle to the specified board if it was found.

Returns

NULL if the board with the specified systemId and boardId was not found.

6.52.2 LabVIEW Block Diagram

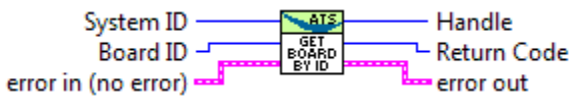

6.53 AlazarGetBoardKind

6.53.1 Function Syntax

ALAZAR_BOARDTYPES AlazarGetBoardKind(HANDLE handle)

Get a board model identifier of the board associated with a board handle.

Parameters

- handle – **[in]** Board handle

Returns

A non-zero board model identifier upon success. See [BoardTypes](#) for converting the identifier into a board model.

Returns

Zero upon error.

6.53.2 LabVIEW Block Diagram



6.53.3 Related Enumerations

enum BoardTypes

Existing board models.

Values:

enumerator ATS_NONE

0

enumerator ATS850

1

enumerator ATS310

2

enumerator ATS330

3

enumerator ATS855

4

enumerator ATS315

5

enumerator ATS335

6

enumerator ATS460

7

enumerator ATS860

8

enumerator ATS660

9

enumerator ATS665

10

enumerator ATS9462

11

enumerator ATS9434

12

enumerator ATS9870

13

enumerator ATS9350

14

enumerator ATS9325

15

enumerator ATS9440

16

enumerator ATS9410

17

enumerator ATS9351

18

enumerator ATS9310

19

enumerator ATS9461

20

enumerator ATS9850

21

enumerator ATS9625

22

enumerator ATG6500

23

enumerator ATS9626

24

enumerator ATS9360

25

enumerator AXI9870

26

enumerator ATS9370

27

enumerator ATU7825

28

enumerator ATS9373

29

enumerator ATS9416

30

enumerator ATS9637

31

enumerator ATS9120

32

enumerator ATS9371

33

enumerator ATS9130

34

enumerator ATS9352

35

enumerator ATS9453

36

enumerator ATS9146

37

enumerator ATS9000

38

enumerator ATST371

39

enumerator ATS9437

40

enumerator ATS9618

41

enumerator ATS9358

42

enumerator ATS9353

44

enumerator ATS9872

45

enumerator ATS9470

46

enumerator ATS9628

47

enumerator ATS9874

48

enumerator ATS9473

49

enumerator ATS9280

50

enumerator ATS4001

51

enumerator ATS9182

52

enumerator ATS9364

53

enumerator ATS9442

54

enumerator ATS9376

55

enumerator ATS9380

56

enumerator ATS9428

57

6.54 AlazarGetBoardRevision

6.54.1 Function Syntax

RETURN_CODE AlazarGetBoardRevision(HANDLE handle, U8 *major, U8 *minor)

Get the PCB hardware revision level of a digitizer board.

AlazarTech periodically updates the PCB hardware of its digitizers to improve functionality. Many PCIE digitizers can report the PCB hardware revision to software. Note that this function is not supported on PCI digitizer boards.

Parameters

- handle – **[in]** The board handle
- major – **[out]** PCB major version number
- minor – **[out]** PCB minor version number

Returns

ApiSuccess upon success, or an error code. See **RETURN_CODE** for more detailed information.

6.54.2 LabVIEW Block Diagram

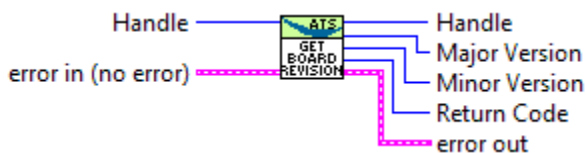

6.55 AlazarGetCPLDVersion

6.55.1 Function Syntax

RETURN_CODE AlazarGetCPLDVersion(HANDLE handle, U8 *major, U8 *minor)

Get the CPLD version number of the specified board.

Parameters

- handle – **[in]** Board handle
- major – **[out]** CPLD version number

- minor – **[out]** CPLD version number

Returns

ApiSuccess upon success, or an error code. See [RETURN_CODE](#) for more detailed information.

6.55.2 LabVIEW Block Diagram

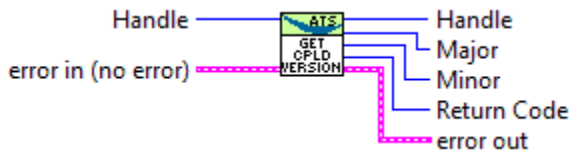

6.56 AlazarGetChannelInfo

6.56.1 Function Syntax

[RETURN_CODE](#) AlazarGetChannelInfo(HANDLE handle, U32 *memorySize, U8 *bitsPerSample)

Get the total on-board memory in samples, and sample size in bits per sample.

Remark

The memory size information is independent of how many channels the board can acquire on simultaneously. When multiple channels acquire data, they share this amount.

Remark

The memory size indication is given for the default packing mode. See documentation about data packing for more information.

Parameters

- handle – **[in]** Board handle.
- memorySize – **[out]** Total size of the on-board memory in samples.
- bitsPerSample – **[out]** Bits per sample.

Returns

ApiSuccess upon success, or an error code. See [RETURN_CODE](#) for more detailed information.

6.56.2 LabVIEW Block Diagram

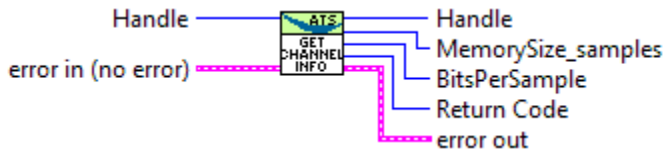

6.57 AlazarGetChannelInfoEx

6.57.1 Function Syntax

RETURN_CODE AlazarGetChannelInfoEx(HANDLE handle, S64 *memorySize, U8 *bitsPerSample)

Get the total on-board memory in samples, and sample size in bits per sample.

Remark

The memory size information is independent of how many channels the board can acquire on simultaneously. When multiple channels acquire data, they share this amount.

Remark

The memory size indication is given for the default packing mode. See documentation about data packing for more information.

Parameters

- handle – **[in]** Board handle.
- memorySize – **[out]** Total size of the on-board memory in samples.
- bitsPerSample – **[out]** Bits per sample.

Returns

ApiSuccess upon success, or an error code. See *RETURN_CODE* for more detailed information.

6.58 AlazarGetDriverVersion

6.58.1 Function Syntax

RETURN_CODE AlazarGetDriverVersion(U8 *major, U8 *minor, U8 *revision)

Get the device driver version of the most recently opened device.

Driver releases are given a version number with the format X.Y.Z where: X is the major release number, Y is the minor release number, and Z is the minor revision number.

Remark

To check the driver version of a specific board, instead of the most recently opened one, see `AlazarGetDriverVersionEx`

See

[AlazarGetSDKVersion\(\)](#) [AlazarGetCPLDVersion\(\)](#)

Parameters

- `major` – **[out]** The driver major version number
- `minor` – **[out]** The driver minor version number
- `revision` – **[out]** The driver revision number

Returns

ApiSuccess upon success, or an error code. See [RETURN_CODE](#) for more detailed information.

6.58.2 LabVIEW Block Diagram

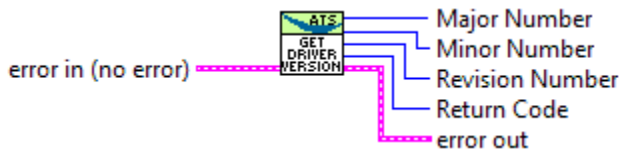

6.59 AlazarGetFPGAVersion

6.59.1 Function Syntax

[RETURN_CODE](#) `AlazarGetFPGAVersion(HANDLE handle, U8 *major, U8 *minor)`

Returns the FPGA version of a digitizer.

Parameters

- `handle` – **[in]** Board handle
- `major` – **[out]** Pointer to a value that gets set to the major FPGA version by this function. Pass NULL if you are not interested in querying this information.
- `minor` – **[out]** Pointer to a value that gets set to the minor FPGA version by this function. Pass NULL if you are not interested in querying this information.

Returns

ApiSuccess upon success, or an error code. See [RETURN_CODE](#) for more detailed information.

6.59.2 LabVIEW Block Diagram

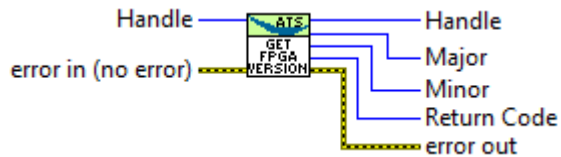

6.60 AlazarGetMaxRecordsCapable

6.60.1 Function Syntax

RETURN_CODE AlazarGetMaxRecordsCapable(HANDLE handle, U32 samplesPerRecord, U32 *maxRecordsPerCapture)

Calculate the maximum number of records that can be captured to on-board memory given the requested number of samples per record.

Note: This function is part of the single-port API. It should not be used with AutoDMA API functions.

Parameters

- handle – **[in]** Board handle
- samplesPerRecord – **[in]** The desired number of samples per record
- maxRecordsPerCapture – **[out]** The maximum number of records per capture possible with the requested value of samples per record.

Returns

ApiSuccess upon success, or an error code. See *RETURN_CODE* for more detailed information.

6.60.2 LabVIEW Block Diagram

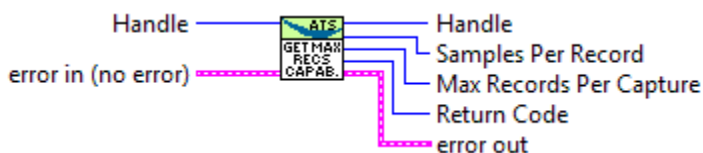

6.61 AlazarGetParameter

6.61.1 Function Syntax

RETURN_CODE AlazarGetParameter(HANDLE handle, U8 channel, U32 parameter, long *retValue)

Get a device parameter as a signed long value.

Parameters

- handle – **[in]** Board handle
- channel – **[in]** The channel to control. See [ALAZAR_CHANNELS](#) for a list of possible values. This parameter only takes unsigned 8-bit values.
- parameter – **[in]** The Parameter to modify. This can be one of [ALAZAR_PARAMETERS](#).
- retValue – **[in]** Parameter's value

Returns

ApiSuccess upon success, or an error code. See [RETURN_CODE](#) for more detailed information.

6.61.2 LabVIEW Block Diagram

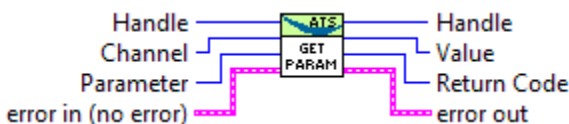

6.61.3 Related Enumerations

enum ALAZAR_PARAMETERS

Parameters suitable to be used with [AlazarSetParameter\(\)](#) and/or [AlazarGetParameter\(\)](#)

Values:

enumerator DATA_WIDTH

0x10000009UL The number of bits per sample

enumerator SETGET_ASYNC_BUFFSIZE_BYTES

0x10000039UL The size of API-allocated DMA buffers in bytes

enumerator SETGET_ASYNC_BUFFCOUNT

0x10000040UL The number of API-allocated DMA buffers

enumerator GET_ASYNC_BUFFERS_PENDING

0x10000050UL DMA buffers currently posted to the board

enumerator GET_ASYNC_BUFFERS_PENDING_FULL

0x10000051UL DMA buffers waiting to be processed by the application

enumerator GET_ASYNC_BUFFERS_PENDING_EMPTY

0x10000052UL DMA buffers waiting to be filled by the board

enumerator SET_DATA_FORMAT

0x10000041UL 0 if the data format is unsigned, and 1 otherwise

enumerator GET_DATA_FORMAT

0x10000042UL 0 if the data format is unsigned, and 1 otherwise

enumerator GET_SAMPLES_PER_TIMESTAMP_CLOCK

0x10000044UL Number of samples per timestamp clock

enumerator GET_RECORDS_CAPTURED

0x10000045UL Records captured since the start of the acquisition (single-port) or buffer (dual-port)

enumerator ECC_MODE

0x10000048UL ECC mode. Member of [ALAZAR_ECC_MODES](#)

enumerator GET_AUX_INPUT_LEVEL

0x10000049UL Read the TTL level of the AUX connector. Member of [ALAZAR_AUX_INPUT_LEVELS](#)

enumerator GET_CHANNELS_PER_BOARD

0x10000070UL Number of analog channels supported by this digitizer

enumerator GET_FPGA_TEMPERATURE

0x10000080UL Current FPGA temperature in degrees Celcius. Only supported by PCIe digitizers. Please note that the returned value is encoded in a 32-bit floating point number. The following code sample demonstrates how to get the temperature value.

```
float temperature_c;
RETURN_CODE rc = AlazarGetParameter(board, 0, GET_FPGA_TEMPERATURE, (long*)&
→temperature_c);
if (rc != ApiSuccess) {
    // Handle error
}
```

enumerator PACK_MODE

0x10000072UL Get/Set the pack mode as a member of [ALAZAR_PACK_MODES](#)

enumerator SET_SINGLE_CHANNEL_MODE

0x10000043UL Reserve all the on-board memory to the channel passed as argument. Single-port only.

enumerator API_FLAGS

0x10000090UL Get/Set the state of the API logging as a member of [ALAZAR_API_TRACE_STATES](#)

enumerator SET_SOFTWARE_CAL_MECHANISM

0x10000100UL Use software calibration mechanism if set to 1, else use standard hardware calibration.

enumerator API_LOG_CLEAR

0x10000102UL Clear the log file of the API logging mechanism

enumerator SETGET_TRIGGER_SKIPPING

0x10000103UL Sets of gets the current value of trigger skipping. Please refer to the trigger skipping section of the documentation for more information.

enumerator GET_ADC_TEMPERATURE

0x10000104UL Current ADC temperature in degrees Celcius. Only supported by PCIe digitizers. Please note that the returned value is encoded in a 32-bit floating point number. The following code sample demonstrates how to get the temperature value.

```
float temperature_c;
RETURN_CODE rc = AlazarGetParameter(board, 0, GET_ADC_TEMPERATURE, (long*)&
→temperature_c);
if (rc != ApiSuccess) {
    // Handle error
}
```

enumerator GET_ONBOARD_MEMORY_USED

0x10000105UL Get the percentage of on-board memory used. Feature only supported for certain board types.

enum ALAZAR_ECC_MODES

ECC Modes.

Values:

enumerator ECC_DISABLE

0 Disable

enumerator ECC_ENABLE

1 Enable

enum ALAZAR_AUX_INPUT_LEVELS

Auxiliary input levels.

Values:

enumerator AUX_INPUT_LOW

0 Low level

enumerator AUX_INPUT_HIGH

1 High level

enum ALAZAR_PACK_MODES

Data pack modes.

Values:

enumerator PACK_DEFAULT

0 Default pack mode of the board

enumerator PACK_8_BITS_PER_SAMPLE

1 8 bits per sample

enumerator PACK_12_BITS_PER_SAMPLE

2 12 bits per sample

enum ALAZAR_API_TRACE_STATES

API trace states.

Values:

enumerator API_DISABLE_TRACE
0 Trace disabled

enumerator API_ENABLE_TRACE
1 Trace enabled

6.62 AlazarGetParameterLL

6.62.1 Function Syntax

RETURN_CODE AlazarGetParameterLL (HANDLE handle, U8 channel, U32 parameter, S64 *retValue)

Get a device parameter as a long long value.

Parameters

- handle – **[in]** Board handle
- channel – **[in]** The channel to control. See [ALAZAR_CHANNELS](#) for a list of possible values. This parameter only takes unsigned 8-bit values.
- parameter – **[in]** The Parameter to modify. This can be one of [ALAZAR_PARAMETERS](#).
- retValue – **[in]** Parameter's value

Returns

ApiSuccess upon success, or an error code. See [RETURN_CODE](#) for more detailed information.

6.63 AlazarGetParameterUL

6.63.1 Function Syntax

RETURN_CODE AlazarGetParameterUL (HANDLE handle, U8 channel, U32 parameter, U32 *retValue)

Get a device parameter as an unsigned long value.

Parameters

- handle – **[in]** Board handle
- channel – **[in]** The channel to control. See [ALAZAR_CHANNELS](#) for a list of possible values. This parameter only takes unsigned 8-bit values.

- parameter – **[in]** The Parameter to modify. This can be one of [ALAZAR_PARAMETERS_UL](#).
- retValue – **[in]** Parameter’s value

Returns

ApiSuccess upon success, or an error code. See [RETURN_CODE](#) for more detailed information.

6.63.2 LabVIEW Block Diagram



6.63.3 Related Enumerations

enum ALAZAR_PARAMETERS_UL

Parameters suitable to be used with [AlazarSetParameterUL\(\)](#) and/or [AlazarGetParameterUL\(\)](#)

Values:

enumerator SET_ADC_MODE

0x10000047UL Sets the ADC mode. The value must be a member of [ALAZAR_ADC_MODES](#). When this parameter is used, channels must be one or more channels OR’ed together. CHANNEL_ALL is not allowed.

enumerator SET_BUFFERS_PER_TRIGGER_ENABLE

0x10000097UL Configures the number of DMA buffers acquired after each trigger enable event. The default value is 1.

It is possible to make the number of buffers per trigger enable infinite by passing a value of 0xFFFFFFFF to this parameter. In this case, trigger enable essentially becomes a “start of acquisition” signal.

Remark

To set the number of buffers per trigger enable, this must be called after [AlazarBeforeAsyncRead\(\)](#) but before [AlazarStartCapture\(\)](#), which means that [AlazarBeforeAsyncRead\(\)](#) must be called with [ADMA_EXTERNAL_STARTCAPTURE](#)

Remark

This parameter is reset in between acquisitions.

enumerator GET_POWER_MONITOR_STATUS

0x10000098UL Queries the status of the power monitor on the board. The value returned is zero if there is no problem. If it is not zero, please send the value returned to AlazarTech's technical support.

enumerator SET_EXT_TRIGGER_RANGE

0x1000001CUL Configure external trigger range. Parameter is as a member of [ALAZAR_EXTERNAL_TRIGGER_RANGES](#)

enum ALAZAR_ADC_MODES

Analog to digital converter modes.

Values:

enumerator ADC_MODE_DEFAULT

0 Default ADC mode

enumerator ADC_MODE_DES

1 Dual-edge sampling mode

6.64 AlazarGetSDKVersion

6.64.1 Function Syntax

RETURN_CODE AlazarGetSDKVersion(U8 *major, U8 *minor, U8 *revision)

Get the driver library version. This is the version of ATSApi.dll under Windows, or ATSApi.so under Linux.

Remark

Note that the version number returned is that of the driver library file, not the ATS-SDK version number. SDK releases are given a version number with the format X.Y.Z where: X is the major release number, Y is the minor release number, and Z is the minor revision number.

See

[AlazarGetCPLDVersion\(\)](#)

See

[AlazarGetDriverVersion\(\)](#)

Parameters

- major – **[out]** The SDK major version number

- minor – **[out]** The SDK minor version number
- revision – **[out]** The SDK revision number

Returns

ApiSuccess upon success, or an error code. See [RETURN_CODE](#) for more detailed information.

6.64.2 LabVIEW Block Diagram

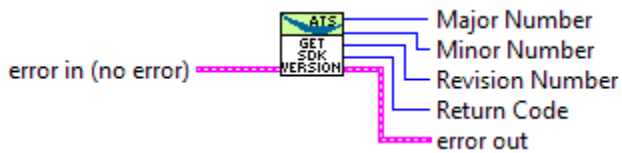

6.65 AlazarGetStatus

6.65.1 Function Syntax

U32 AlazarGetStatus(HANDLE handle)

Return a bitmask with board status information.

Note: This function is part of the single-port data acquisition API. It cannot be used with the dual-port AutoDMA APIs.

Parameters

- handle – **[in]** Board handle

Returns

If the function fails, the return value is 0xFFFFFFFF. Upon success, the return value is a bit mask of the following values:

- 1 : At least one trigger timeout occurred.
- 2 : At least one channel A sample was out of range during the last acquisition.
- 4 : At least one channel B sample was out of range during the last acquisition.
- 8 : PLL is locked (ATS660 only)

6.65.2 LabVIEW Block Diagram

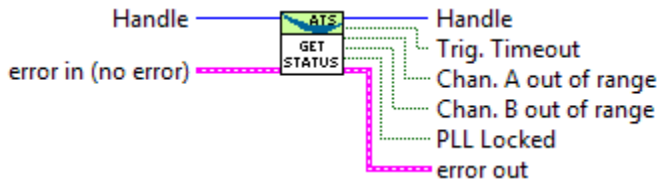

6.66 AlazarGetSystemHandle

6.66.1 Function Syntax

HANDLE AlazarGetSystemHandle(U32 systemId)

Return the handle of the master board in the specified board system.

Remark

If the board system specified contains a single, independent board, this function returns a handle to that board.

Parameters

- systemId – **[in]** System identification number

Returns

ApiSuccess upon success, or an error code. See [RETURN_CODE](#) for more detailed information.

6.66.2 LabVIEW Block Diagram



6.67 AlazarGetTriggerAddress

6.67.1 Function Syntax

[RETURN_CODE](#) AlazarGetTriggerAddress(HANDLE handle, U32 Record, U32 *TriggerAddress, U32 *TimeStampHighPart, U32 *TimeStampLowPart)

Get the timestamp and trigger address of the trigger event in a record acquired to on-board memory.

The following code fragment demonstrates how to convert the trigger timestamp returned by [AlazarGetTriggerAddress\(\)](#) from counts to seconds.

```
__int64 timeStamp_cnt;
timeStamp_cnt = ((__int64) timestampHighPart) << 8;
timeStamp_cnt |= timestampLowPart & 0x0fff;
double samplesPerTimestampCount = 2; // board specific constant
double samplesPerSec = 50.e6; // sample rate
double timeStamp_sec = (double) samplesPerTimestampCount *
timeStamp_cnt / samplesPerSec;
```

The sample per timestamp count value depends on the board model. See board-specific information to know which value applies to which board.

Remark

This function can be used in single-port acquisitions only.

Parameters

- handle – **[in]** Board handle
- Record – **[in]** Record in acquisition (1-indexed)
- TriggerAddress – **[out]** The trigger address
- TimeStampHighPart – **[out]** The most significant 32-bits of a record timestamp
- TimeStampLowPart – **[out]** The least significant 8-bits of a record timestamp

Returns

[ApiError2](#) (604) if it is called after a dual-port acquisition. This function should be called after a single-port acquisition only.

Returns

[ApiSuccess](#) upon success, or an error code. See [RETURN_CODE](#) for more detailed information.

6.67.2 LabVIEW Block Diagram

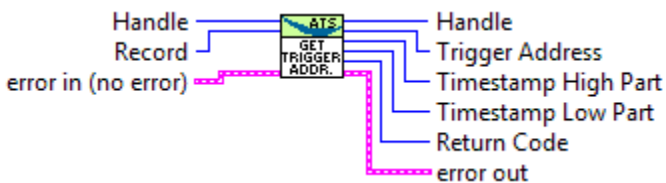

6.68 AlazarGetTriggerTimestamp

6.68.1 Function Syntax

RETURN_CODE AlazarGetTriggerTimestamp(HANDLE handle, U32 Record, U64 *Timestamp_samples)

Retrieve the timestamp, in sample clock periods, of a record acquired to on-board memory.

Remark

This function is part of the single-port data acquisition API. It cannot be used to retrieve the timestamp of records acquired using dual-port AutoDMA APIs.

Parameters

- handle – **[in]** Board handle
- Record – **[in]** 1-indexed record in acquisition
- Timestamp_samples – **[in]** Record timestamp, in sample clock periods

Returns

ApiSuccess upon success, or an error code. See *RETURN_CODE* for more detailed information.

6.69 AlazarGetWhoTriggeredBySystemHandle

6.69.1 Function Syntax

U32 AlazarGetWhoTriggeredBySystemHandle(HANDLE systemHandle, U32 boardId, U32 recordNumber)

Return which event caused a board system to trigger and capture a record to on-board memory.

Note: This function is part of the single-port API. It cannot be used with the dual-port AutoDMA APIs.

Warning: This API routine will not work with ATS850 version 1.2 hardware. Version 1.3 and higher version number of ATS850 are fully supported, as are all versions of ATS330 and ATS310.

Parameters

- systemHandle – **[in]** Handle to a master board in a board system.
- boardId – **[in]** Board identifier of a board in the specified system.
- recordNumber – **[in]** Record in acquisition (1-indexed)

Returns

One of the following values:

- 0 : This board did not cause the system to trigger
- 1 : CH A on this board caused the system to trigger
- 2 : CH B on this board caused the system to trigger
- 3 : EXT TRIG IN on this board caused the system to trigger
- 4 : Both CH A and CH B on this board caused the system to trigger
- 5 : Both CH A and EXT TRIG IN on this board caused the system to trigger
- 6 : Both CH B and EXT TRIG IN on this board caused the system to trigger
- 7 : A trigger timeout on this board caused the system to trigger

6.69.2 LabVIEW Block Diagram

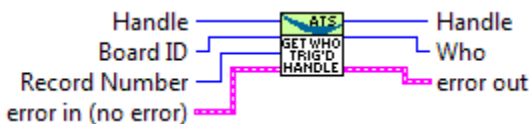

6.70 AlazarGetWhoTriggeredBySystemID

6.70.1 Function Syntax

U32 AlazarGetWhoTriggeredBySystemID(U32 systemId, U32 boardId, U32 recordNumber)

Return which event caused a board system to trigger and capture a record to on-board memory.

Note: This function is part of the single-port API. It cannot be used with the dual-port AutoDMA APIs.

Warning: This API routine will not work with ATS850 version 1.2 hardware. Version 1.3 and higher version number of ATS850 are fully supported, as are all versions of ATS330 and ATS310.

Parameters

- `systemId` – **[in]** System identifier
- `boardId` – **[in]** Board identifier of a board in the specified system.
- `recordNumber` – **[in]** Record in acquisition (1-indexed)

Returns

One of the following values:

- 0 : This board did not cause the system to trigger
- 1 : CH A on this board caused the system to trigger
- 2 : CH B on this board caused the system to trigger
- 3 : EXT TRIG IN on this board caused the system to trigger
- 4 : Both CH A and CH B on this board caused the system to trigger
- 5 : Both CH A and EXT TRIG IN on this board caused the system to trigger
- 6 : Both CH B and EXT TRIG IN on this board caused the system to trigger
- 7 : A trigger timeout on this board caused the system to trigger

6.70.2 LabVIEW Block Diagram

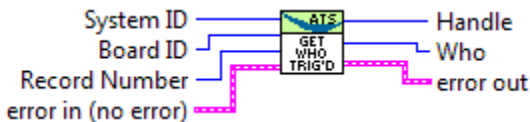

6.71 AlazarHyperDisp

6.71.1 Function Syntax

RETURN_CODE AlazarHyperDisp(`HANDLE handle`, `void *buffer`, `U32 bufferSize`, `U8 *viewBuffer`, `U32 viewBufferSize`, `U32 numOfPixels`, `U32 option`, `U32 channelSelect`, `U32 record`, `long transferOffset`, `U32 *error`)

Enable the on-board FPGA to process records acquired to on-board memory, and transfer the processed data to host memory.

HyperDisp processing enables the on-board FPGA to divide a record acquired to on-board memory into intervals, find the minimum and maximum sample values during each interval, and transfer an array of minimum and maximum sample values to a

buffer in host memory. This allows the acquisition of relatively long records to on-board memory, but the transfer of relatively short, processed records to a buffer in host memory.

For example, it would take an ATS860-256M about ~2.5 seconds to transfer a 250,000,000 sample record from on-board memory, across the PCI bus, to a buffer in host memory. With HyperDisp enabled, it would take the on-board FPGA a fraction of a second to process the record and transfer a few hundred samples from on-board memory, across the PCI bus, to a buffer in host memory.

Note: This function is part of the single-port data acquisition API. It cannot be used with the dual-port AutoDMA APIs.

Parameters

- handle – **[in]** Board handle
- buffer – **[in]** Reserved (Set to NULL)
- bufferSize – **[in]** Number of samples to process
- viewBuffer – **[out]** Buffer to receive processed data
- viewBufferSize – **[in]** Size of processed data buffer in bytes
- numOfPixels – **[in]** Number of HyperDisp points
- option – **[in]** Processing mode. Pass 1 to enable HyperDisp processing.
- channelSelect – **[in]** Channel to process
- record – **[in]** Record to process (1-indexed)
- transferOffset – **[in]** The offset, in samples, of first sample to process relative to the trigger position in record.
- error – **[out]** Pointer to value to receive a result code.

Returns

ApiSuccess upon success, or an error code. See [RETURN_CODE](#) for more detailed information.

6.72 AlazarInputControl

6.72.1 Function Syntax

RETURN_CODE AlazarInputControl(HANDLE handle, U8 channel, U32 coupling, U32 inputRange, U32 impedance)

Select the input coupling, range, and impedance of a digitizer channel.

Parameters

- `handle` – **[in]** Board handle.
- `channel` – **[in]** The channel to control. See [ALAZAR_CHANNELS](#) for a list of possible values. This parameter only takes unsigned 8-bit values. To configure channel I and above, see [AlazarInputControlEx\(\)](#).
- `inputRange` – **[in]** Specify the input range of the selected channel. See [ALAZAR_INPUT_RANGES](#) for a list of all existing input ranges. Consult board-specific information to see which input ranges are supported by each board.
- `coupling` – **[in]** Specifies the coupling of the selected channel. Must be an element of [ALAZAR_COUPLINGS](#)
- `impedance` – **[in]** Specify the input impedance to set for the selected channel. See [ALAZAR_IMPEDANCES](#) for a list of all existing values. See the board-specific documentation to see impedances supported by various boards.

Returns

[ApiSuccess](#) upon success, or an error code. See [RETURN_CODE](#) for more detailed information.

6.72.2 LabVIEW Block Diagram

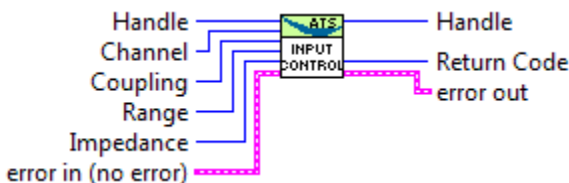

6.72.3 Related Enumerations

enum ALAZAR_CHANNELS

Channel identifiers.

Values:

enumerator CHANNEL_ALL

0x00000000 All channels

enumerator CHANNEL_A

0x00000001 Channel A

enumerator CHANNEL_B
0x00000002 Channel B

enumerator CHANNEL_C
0x00000004 Channel C

enumerator CHANNEL_D
0x00000008 Channel D

enumerator CHANNEL_E
0x00000010 Channel E

enumerator CHANNEL_F
0x00000020 Channel F

enumerator CHANNEL_G
0x00000040 Channel G

enumerator CHANNEL_H
0x00000080 Channel H

enumerator CHANNEL_I
0x00000100 Channel I

enumerator CHANNEL_J
0x00000200 Channel J

enumerator CHANNEL_K
0x00000400 Channel K

enumerator CHANNEL_L
0x00000800 Channel L

enumerator CHANNEL_M
0x00001000 Channel M

enumerator CHANNEL_N
0x00002000 Channel N

enumerator CHANNEL_O
0x00004000 Channel O

enumerator CHANNEL_P
0x00008000 Channel P

enum ALAZAR_INPUT_RANGES
Input range identifiers.
Values:

enumerator INPUT_RANGE_PM_20_MV
0x00000001UL +/- 20mV

enumerator INPUT_RANGE_PM_40_MV
0x00000002UL +/- 40mV

enumerator INPUT_RANGE_PM_50_MV
0x00000003UL +/- 50mV

enumerator INPUT_RANGE_PM_80_MV
0x00000004UL +/- 80mV

enumerator INPUT_RANGE_PM_100_MV
0x00000005UL +/- 100mV

enumerator INPUT_RANGE_PM_200_MV
0x00000006UL +/- 200mV

enumerator INPUT_RANGE_PM_400_MV
0x00000007UL +/- 400mV

enumerator INPUT_RANGE_PM_500_MV
0x00000008UL +/- 500mV

enumerator INPUT_RANGE_PM_800_MV
0x00000009UL +/- 800mV

enumerator INPUT_RANGE_PM_1_V
0x0000000AUL +/- 1V

enumerator INPUT_RANGE_PM_2_V
0x0000000BUL +/- 2V

enumerator INPUT_RANGE_PM_4_V
0x0000000CUL +/- 4V

enumerator INPUT_RANGE_PM_5_V
0x0000000DUL +/- 5V

enumerator INPUT_RANGE_PM_8_V
0x0000000EUL +/- 8V

enumerator INPUT_RANGE_PM_10_V
0x0000000FUL +/- 10V

enumerator INPUT_RANGE_PM_20_V
0x00000010UL +/- 20V

enumerator INPUT_RANGE_PM_40_V
0x00000011UL +/- 40V

enumerator INPUT_RANGE_PM_16_V
0x00000012UL +/- 16V

enumerator INPUT_RANGE_UNCALIBRATED
0x00000020UL no gain

enumerator INPUT_RANGE_PM_1_V_25
0x00000021UL +/- 1.25V

enumerator INPUT_RANGE_PM_2_V_5
0x00000025UL +/- 2.5V

enumerator INPUT_RANGE_PM_125_MV
0x00000028UL +/- 125mV

enumerator INPUT_RANGE_PM_250_MV
0x00000030UL +/- 250mV

enumerator INPUT_RANGE_0_TO_40_MV
0x00000031UL 0 to 40mV

enumerator INPUT_RANGE_0_TO_80_MV
0x00000032UL 0 to 80mV

enumerator INPUT_RANGE_0_TO_100_MV
0x00000033UL 0 to 100mV

enumerator INPUT_RANGE_0_TO_160_MV
0x00000034UL 0 to 160mV

enumerator INPUT_RANGE_0_TO_200_MV
0x00000035UL 0 to 200mV

enumerator INPUT_RANGE_0_TO_250_MV
0x00000036UL 0 to 250mV

enumerator INPUT_RANGE_0_TO_400_MV
0x00000037UL 0 to 400mV

enumerator INPUT_RANGE_0_TO_500_MV
0x00000038UL 0 to 500mV

enumerator INPUT_RANGE_0_TO_800_MV
0x00000039UL 0 to 800mV

enumerator INPUT_RANGE_0_TO_1_V
0x0000003AUL 0 to 1V

enumerator INPUT_RANGE_0_TO_1600_MV
0x0000003BUL 0 to 1.6V

enumerator INPUT_RANGE_0_TO_2_V
0x0000003CUL 0 to 2V

enumerator INPUT_RANGE_0_TO_2_V_5
0x0000003DUL 0 to 2.5V

enumerator INPUT_RANGE_0_TO_4_V
0x0000003EUL 0 to 4V

enumerator INPUT_RANGE_0_TO_5_V
0x0000003FUL 0 to 5V

enumerator INPUT_RANGE_0_TO_8_V
0x00000040UL 0 to 8V

enumerator INPUT_RANGE_0_TO_10_V
0x00000041UL 0 to 10V

enumerator INPUT_RANGE_0_TO_16_V
0x00000042UL 0 to 16V

enumerator INPUT_RANGE_0_TO_20_V
0x00000043UL 0 to 20V

enumerator INPUT_RANGE_0_TO_80_V
0x00000044UL 0 to 80V

enumerator INPUT_RANGE_0_TO_32_V
0x00000045UL 0 to 32V

enumerator INPUT_RANGE_0_TO_MINUS_40_MV
0x00000046UL 0 to -40mV

enumerator INPUT_RANGE_0_TO_MINUS_80_MV
0x00000047UL 0 to -80mV

enumerator INPUT_RANGE_0_TO_MINUS_100_MV
0x00000048UL 0 to -100mV

enumerator INPUT_RANGE_0_TO_MINUS_160_MV
0x00000049UL 0 to -160mV

enumerator INPUT_RANGE_0_TO_MINUS_200_MV
0x0000004AUL 0 to -200mV

enumerator INPUT_RANGE_0_TO_MINUS_250_MV
0x0000004BUL 0 to -250mV

enumerator INPUT_RANGE_0_TO_MINUS_400_MV
0x0000004CUL 0 to -400mV

enumerator INPUT_RANGE_0_TO_MINUS_500_MV
0x0000004DUL 0 to -500mV

enumerator INPUT_RANGE_0_TO_MINUS_800_MV
0x0000004EUL 0 to -800mV

enumerator INPUT_RANGE_0_TO_MINUS_1_V
0x0000004FUL 0 to -1V

enumerator INPUT_RANGE_0_TO_MINUS_1600_MV
0x00000050UL 0 to -1.6V

enumerator INPUT_RANGE_0_TO_MINUS_2_V
0x00000051UL 0 to -2V

enumerator INPUT_RANGE_0_TO_MINUS_2_V_5
0x00000052UL 0 to -2.5V

enumerator INPUT_RANGE_0_TO_MINUS_4_V
0x00000053UL 0 to -4V

enumerator INPUT_RANGE_0_TO_MINUS_5_V
0x00000054UL 0 to -5V

enumerator INPUT_RANGE_0_TO_MINUS_8_V
0x00000055UL 0 to -8V

enumerator INPUT_RANGE_0_TO_MINUS_10_V
0x00000056UL 0 to -10V

enumerator INPUT_RANGE_0_TO_MINUS_16_V
0x00000057UL 0 to -16V

enumerator INPUT_RANGE_0_TO_MINUS_20_V
0x00000058UL 0 to 20V

enumerator INPUT_RANGE_0_TO_MINUS_80_V
0x00000059UL 0 to 80V

enumerator INPUT_RANGE_0_TO_MINUS_32_V
0x00000060UL 0 to 32V

enumerator INPUT_RANGE_UNCALIBRATED_PM_750_MV
0x00000061UL no gain +/- 750mV

enumerator INPUT_RANGE_PM_560_MV
0x00000062UL +/- 560mV

enum ALAZAR_COUPLINGS

Coupling identifiers.

Values:

enumerator AC_COUPLING

0x00000001UL AC coupling

enumerator DC_COUPLING

0x00000002UL DC coupling

enumerator GND_COUPLING

0x00000004UL Ground coupling

enum ALAZAR_IMPEDANCES

Impedance indentifiers.

Values:

enumerator IMPEDANCE_1M_OHM

0x00000001UL

enumerator IMPEDANCE_50_OHM

0x00000002UL

enumerator IMPEDANCE_75_OHM

0x00000004UL

enumerator IMPEDANCE_300_OHM

0x00000008UL

enumerator IMPEDANCE_100_OHM

0x00000010UL

6.73 AlazarInputControlEx

6.73.1 Function Syntax

RETURN_CODE AlazarInputControlEx(HANDLE handle, U32 channel, U32 couplingId, U32 rangeId, U32 impedanceId)

Select the input coupling, range and impedance of a digitizer channel.

This function is the equivalent of *AlazarInputControl()* with a U32-typed parameter to pass the channel. This allows for boards with more than 8 channels to be configured.

6.73.2 LabVIEW Block Diagram

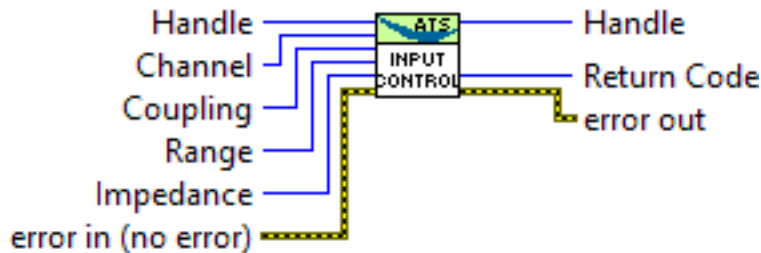

6.74 AlazarNumOfSystems

6.74.1 Function Syntax

U32 AlazarNumOfSystems(void)

Get the total number of board systems detected.

A *board system* is a group of one or more digitizer boards that share clock and trigger signals. A board system may be composed of a single independent board, or a group of two or more digitizer boards connected together with a *SyncBoard*.

Returns

The total number of board systems detected

6.75 AlazarOCTIgnoreBadClock

6.75.1 Function Syntax

RETURN_CODE AlazarOCTIgnoreBadClock(HANDLE handle, U32 enable, double goodClockDuration_seconds, double badClockDuration_seconds, double *triggerCycleTime_seconds, double *triggerPulseWidth_seconds)

Enables or disables the *OCT ignore bad clock* mechanism.

This function must be called before an acquisition starts. It informs the digitizer about portions of time during which the external clock signal is valid, and others during which it is invalid and should be ignored.

“good” clock portions are durations of time during which the external clock signal is valid, i.e. within the board’s specifications. “bad” clock portions are durations of time during which the clock signal is invalid.

When *OCT Ignore Bad Clock* is active, the digitizer must be set in external TTL trigger mode, and in external clock mode.

The external clock signal must be good when trigger events are received on the external trigger connector. The duration of time after the trigger event during which the clock signal is good is specified in `goodClockDuration_seconds`. After this good duration, the portion of time during which the clock may be bad is specified in `badClockDuration_seconds`.

The sum of `goodClockDuration_seconds` and `badClockDuration_seconds` must be less than the trigger cycle time. This means that the clock signal must be back to being good before the next trigger event.

Remark

This function must be called prior to calling *AlazarBeforeAsyncRead()*.

Remark

Trigger source must be set to *TRIG_EXTERNAL*

Remark

Trigger input range must be *ETR_TTL*.

Remark

Clock source must be set to *FAST_EXTERNAL_CLOCK*.

Parameters

- `handle` – **[in]** Handle to board
- `enable` – **[in]** Enables (1) or disables (0) the feature
- `goodClockDuration_seconds` – **[in]** Good clock duration in seconds
- `badClockDuration_seconds` – **[in]** Bad clock duration in seconds
- `triggerCycleTime_seconds` – **[out]** Trigger cycle time measured by the board
- `triggerPulseWidth_seconds` – **[out]** Trigger pulse width measured by the board

Returns

If the function succeeds, it returns *ApiSuccess*.

Returns

If an invalid board handle is passed to the function, it returns *ApiNullParam*.

Returns

If an invalid value is passed for any of `enable`, `goodClockDuration_seconds` or `badClockDuration_seconds`, it returns [ApiInvalidData](#).

Returns

If OCT ignore bad clock is not supported by the board and/or firmware, it returns [ApiOCTIgnoreBadClockNotSupported](#).

Returns

If no trigger signal is detected by the board, it returns [ApiOCTNoTriggerDetected](#).

Returns

If the trigger rate is too fast for the provided good and bad clock durations, it returns [ApiOCTTriggerTooFast](#).

6.75.2 LabVIEW Block Diagram

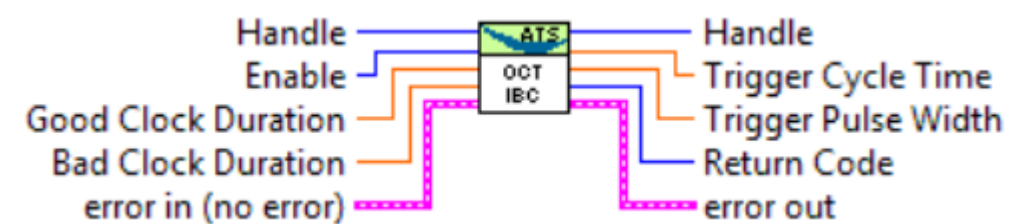

6.76 AlazarPostAsyncBuffer

6.76.1 Function Syntax

RETURN_CODE AlazarPostAsyncBuffer(HANDLE handle, void *buffer, U32 bufferLength_bytes)

Posts a DMA buffer to a board.

This function adds a DMA buffer to the end of a list of buffers available to be filled by the board. Use [AlazarWaitAsyncBufferComplete\(\)](#) to determine if the board has received sufficient trigger events to fill this buffer.

Remark

You must call [AlazarBeforeAsyncRead\(\)](#) before calling [AlazarPostAsyncBuffer\(\)](#).

Remark

The `bufferLength_bytes` parameter must be equal to the product of the number of bytes per record, the number of records per buffer and the number of enabled channels. If record headers are enabled, the number of bytes per record must include the size of the record header (16 bytes).

Warning: You must call *AlazarAbortAsyncRead()* before your application exits if you have called *AlazarPostAsyncBuffer()* and buffers are pending when your application exits.

Parameters

- handle – **[in]** Handle to board
- buffer – **[in]** Pointer to buffer that will eventually receive data from the digitizer board.
- bufferLength_bytes – **[in]** The length of the buffer in bytes.

Returns

ApiSuccess upon success, or an error code. See *RETURN_CODE* for more detailed information.

6.77 AlazarQueryCapability

6.77.1 Function Syntax

RETURN_CODE AlazarQueryCapability(HANDLE handle, U32 capability, U32 reserved, U32 *retValue)

Get a device attribute as an unsigned 32-bit integer.

Parameters

- handle – **[in]** Board handle
- capability – **[in]** The board capability to query. Must be a member of *ALAZAR_CAPABILITIES*.
- reserved – **[in]** Pass 0
- retValue – **[out]** Capability value

Returns

ApiSuccess upon success, or an error code. See *RETURN_CODE* for more detailed information.

6.77.2 LabVIEW Block Diagram

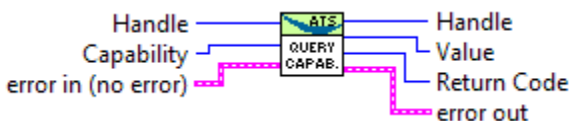

6.77.3 Related Enumerations

enum ALAZAR_CAPABILITIES

Capabilities that can be queried through [AlazarQueryCapability\(\)](#)

Values:

enumerator GET_SERIAL_NUMBER

0x10000024UL Board's serial number

enumerator GET_FIRST_CAL_DATE

0x10000025UL First calibration date

enumerator GET_LATEST_CAL_DATE

0x10000026UL Latest calibration date

enumerator GET_LATEST_TEST_DATE

0x10000027UL Latest test date

enumerator GET_LATEST_CAL_DATE_MONTH

0x1000002DUL Month of latest calibration

enumerator GET_LATEST_CAL_DATE_DAY

0x1000002EUL Day of latest calibration

enumerator GET_LATEST_CAL_DATE_YEAR

0x1000002FUL Year of latest calibration

enumerator GET_BOARD_OPTIONS_LOW

0x10000037UL Low part of the board options

enumerator GET_BOARD_OPTIONS_HIGH

0x10000038UL High part of the board options

enumerator MEMORY_SIZE

0x1000002AUL The memory size in samples

enumerator ASOPC_TYPE

0x1000002CUL The FPGA signature

enumerator BOARD_TYPE

0x1000002BUL The board type as a member of ALAZAR_BOARDTYPES

enumerator GET_PCIE_LINK_SPEED

0x10000030UL PCIe link generation

enumerator GET_PCIE_LINK_WIDTH

0x10000031UL PCIe link width in lanes

enumerator GET_MAX_PRETRIGGER_SAMPLES

0x10000046UL Maximum number of pre-trigger samples.

enumerator GET_CPF_DEVICE

0x10000071UL User-programmable FPGA device. 1 = SL50, 2 = SE260

enumerator HAS_RECORD_FOOTERS_SUPPORT

0x10000073UL Queries if the board supports NPT record footers. Returns 1 if the feature is supported and 0 otherwise

enumerator CAP_SUPPORTS_TRADITIONAL_AUTODMA

0x10000074UL Queries if the board supports the AutoDMA Traditional acquisition mode. Returns 1 if the feature is supported and 0 otherwise.

enumerator CAP_SUPPORTS_NPT_AUTODMA

0x10000075UL Queries if the board supports the AutoDMA NPT acquisition mode. Returns 1 if the feature is supported and 0 otherwise.

enumerator CAP_MAX_NPT_PRETRIGGER_SAMPLES

0x10000076UL Queries the maximum number of pre-trigger samples that can be requested in the AutoDMA NPT acquisition mode. This amount is shared between all the channels of the board.

enumerator CAP_IS_VFIFO_BOARD

0x10000077UL Tests if this board of the virtual-FIFO type.

enumerator CAP_SUPPORTS_NATIVE_SINGLE_PORT

0x10000078UL Tests if this board features native support for single-port acquisitions. Returns 1 if native support is present, and 0 otherwise.

enumerator CAP_SUPPORT_8_BIT_PACKING

0x10000079UL Tests if this board supports 8-bit data packing. Returns 1 if this board has a native resolution of more than 8 bits and supports 8-bit packing.

enumerator CAP_SUPPORT_12_BIT_PACKING

0x10000080UL Tests if this board supports 12-bit data packing. Returns 1 if support is present, and 0 otherwise.

enumerator HAS_PARALLEL_DMA_SUPPORT

0x10000072UL Queries if the board supports parallel dma. Returns 1 if the feature is supported, and 0 otherwise.

enumerator HAS_SEQUENTIAL_DMA_SUPPORT

0x10000086UL Queries if the board supports sequential dma. Returns 1 if the feature is supported, and 0 otherwise.

enumerator HAS_RECORD_HEADERS_SUPPORT

0x10000081UL Tests if this board supports record headers. Returns 1 if support is present, and 0 otherwise.

enumerator CAP_SUPPORT_TRADITIONAL_SAMPLES_INTERLEAVED

0x10000082UL Tests if this board supports samples interleaved in traditional mode. Returns 1 if support is present, and 0 otherwise.

enumerator CAP_SUPPORT_SOFTWARE_CAL

0x10000083UL Tests if this board supports software calibration. Returns 1 if support is present, and 0 otherwise.

enumerator CAP_SUPPORTS_API_LOG_CLEAR

0x10000084UL Tests if this board supports API log clear. Returns 1 if support is present, and 0 otherwise.

enumerator CAP_SUPPORTS_TRIGGER_SKIPPING

0x10000085UL Tests if this board supports trigger skipping. Returns 1 if support is present, and 0 otherwise.

enum ALAZAR_BOARD_OPTIONS_LOW

AlazarTech board options. Lower 32-bits.

Values:

enumerator OPTION_STREAMING_DMA

1UL << 0

enumerator OPTION_EXTERNAL_CLOCK

1UL << 1

enumerator OPTION_DUAL_PORT_MEMORY

1UL << 2

enumerator OPTION_180MHZ_OSCILLATOR

1UL << 3

enumerator OPTION_LVTTL_EXT_CLOCK

1UL << 4

enumerator OPTION_SW_SPI

1UL << 5

enumerator OPTION_ALT_INPUT_RANGES

1UL << 6

enumerator OPTION_VARIABLE_RATE_10MHZ_PLL

1UL << 7

enumerator OPTION_MULTI_FREQ_VCO

1UL << 7

enumerator OPTION_2GHZ_ADC

1UL << 8

enumerator OPTION_DUAL_EDGE_SAMPLING

1UL << 9

enumerator OPTION_DCLK_PHASE

1UL << 10

enumerator OPTION_WIDEBAND

1UL << 11

enumerator OPTION_LOW_CROSSTALK

1UL << 12

enumerator OPTION_ON_FPGA_FFT

1UL << 13

enumerator OPTION_ANALOG_INPUT

1UL << 14

enumerator OPTION_USER_CALIBRATION

1UL << 15

enumerator OPTION_DAC_OUTPUT

1UL << 16

enum ALAZAR_BOARD_OPTIONS_HIGH

AlazarTech board options. Higher 32-bits.

Values:

enumerator OPTION_OEM_FPGA

1UL << 15

6.78 AlazarQueryCapabilityLL

6.78.1 Function Syntax

RETURN_CODE AlazarQueryCapabilityLL(HANDLE handle, U32 capability, U32 reserved, S64 *retValue)

Get a device attribute as a 64-bit integer.

Parameters

- handle – **[in]** Board handle
- capability – **[in]** The board capability to query. Must be a member of [ALAZAR_CAPABILITIES](#).
- reserved – **[in]** Pass 0
- retValue – **[out]** Capability value

Returns

ApiSuccess upon success, or an error code. See [RETURN_CODE](#) for more detailed information.

6.79 AlazarRead

6.79.1 Function Syntax

U32 AlazarRead(HANDLE handle, U32 channelId, void *buffer, int elementSize, long record, long transferOffset, U32 transferLength)

Read all or part of a record from on-board memory to host memory (RAM).

The record must be less than 2,147,483,648 samples long.

Remark

AlazarRead() can transfer segments of a record. This may be useful if a full record is too large to transfer as a single clock, or if only part of a record is of interest.

Remark

Use *AlazarReadEx()* To transfer records with more than 2 billion samples.

Note: *AlazarRead()* is part of the single-port API, it cannot be used in a dual-port context.

Parameters

- handle – **[in]** Board handle
- channelId – **[in]** The channel identifier of the record to read.
- buffer – **[out]** Buffer to receive sample data
- elementSize – **[in]** Number of bytes per sample
- record – **[in]** Index of the record to transfer (1-indexed)
- transferOffset – **[in]** The offset, in samples, from the trigger position in the record, of the first sample to transfer.
- transferLength – **[in]** The number of samples to transfer.

Returns

ApiSuccess upon success, or an error code. See *RETURN_CODE* for more detailed information.

6.79.2 LabVIEW Block Diagram

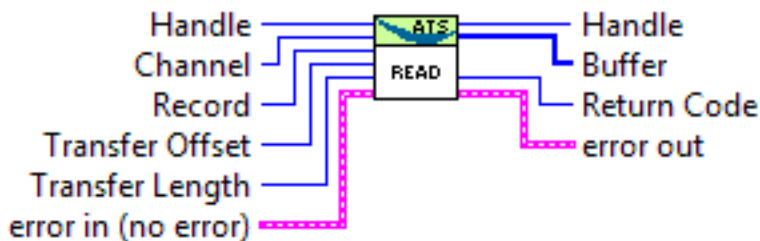

6.80 AlazarReadEx

6.80.1 Function Syntax

U32 AlazarReadEx(HANDLE handle, U32 channelId, void *buffer, int elementSize, long record, INT64 transferOffset, U32 transferLength)

Read all or part of a record from an acquisition to on-board memory from on-board memory to a buffer in host memory. The record may be longer than 2 billion samples.

Use [AlazarRead\(\)](#) or [AlazarReadEx\(\)](#) to transfer records with less than 2 billion samples. Use [AlazarReadEx\(\)](#) to transfer records with more than 2 billion samples.

Remark

[AlazarReadEx\(\)](#) can transfer segments of a record to on-board memory. This may be useful if a full record is too large to transfer as a single block, or if only part of a record is of interest.

Note: [AlazarReadEx\(\)](#) is part of the single-port data acquisition API. It cannot be used with the dual-port AutoDMA APIs.

Parameters

- handle – **[in]** Handle to board
- channelId – **[in]** channel identifier of record to read
- buffer – **[out]** Buffer to receive sample data
- elementSize – **[in]** number of bytes per sample
- record – **[in]** record in on-board memory to transfer to buffer (1-indexed).
- transferOffset – **[in]** The offset in samples from the trigger position in the record of the first sample in the record in on-board memory to transfer to the buffer
- transferLength – **[in]** The number of samples to transfer from the record in on-board memory to the buffer.

Returns

[ApiSuccess](#) upon success, or an error code. See [RETURN_CODE](#) for more detailed information.

6.81 AlazarResetTimeStamp

6.81.1 Function Syntax

RETURN_CODE AlazarResetTimeStamp(HANDLE handle, U32 option)

Resets the record timestamp counter.

Remark

This function is not supported by ATS310, ATS330 and ATS850

Parameters

- handle – **[in]** Handle to board
- option – **[in]** Record timestamp reset option. Can be one of [ALAZAR_TIMESTAMP_RESET_OPTIONS](#).

Returns

ApiSuccess upon success, or an error code. See [RETURN_CODE](#) for more detailed information.

6.81.2 LabVIEW Block Diagram



6.81.3 Related Enumerations

enum ALAZAR_TIMESTAMP_RESET_OPTIONS

Timestamp reset options. See [AlazarResetTimeStamp\(\)](#)

Values:

enumerator TIMESTAMP_RESET_FIRSTTIME_ONLY

0x00000000UL

enumerator TIMESTAMP_RESET_ALWAYS

0x00000001UL

6.82 AlazarSetADCBackgroundCompensation

6.82.1 Function Syntax

RETURN_CODE AlazarSetADCBackgroundCompensation(HANDLE handle, BOOL active)

Activates or deactivates the ADC background compensation.

Remark

This feature does not exist on all boards. Please check board-specific information for more details.

Parameters

- handle – **[in]** Handle to board
- active – **[in]** Determines whether this function activates or deactivates the ADC background compensation.

Returns

ApiSuccess upon success, or an error code. See *RETURN_CODE* for more detailed information.

6.83 AlazarSetBWLimit

6.83.1 Function Syntax

RETURN_CODE AlazarSetBWLimit(HANDLE handle, U32 channel, U32 enable)

Activates the bandwidth limiter of an input channel. Not all boards support a bandwidth limiter. See board-specific documentation for more information.

Remark

The bandwidth limiter is disabled by default. When enabled, the bandwidth is limited to approximately 20 MHz.

Parameters

- handle – **[in]** Board handle
- channel – **[in]** The channel identifier. Must be a channel from *ALAZAR_CHANNELS*.
- enable – **[in]** Pass 1 to enable the bandwidth limit, or zero otherwise.

Returns

ApiSuccess upon success, or an error code. See *RETURN_CODE* for more detailed information.

6.83.2 LabVIEW Block Diagram

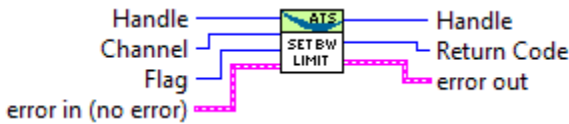

6.84 AlazarSetCaptureClock

6.84.1 Function Syntax

RETURN_CODE AlazarSetCaptureClock(HANDLE handle, U32 source, U32 sampleRateIdOrValue, U32 edgeId, U32 decimation)

Configure the sample clock source, edge and decimation.

- If a board is configured to use a [SLOW_EXTERNAL_CLOCK](#) clock source, the maximum decimation value is 1.
- If an ATS9350 is configured to use an [EXTERNAL_CLOCK_10MHZ_REF](#) clock source, the decimation value must be 1, 2, 4 or any multiple of 5. Note that the sample rate identifier value must be 500000000, and the sample rate will be 500 MHz divided by the decimation value.
- If an ATS9360 / ATS9371 / ATS9373 is configured to use an [EXTERNAL_CLOCK_10MHZ_REF](#) clock source, the maximum decimation value is 1.
- If an ATS9850 is configured to use an [EXTERNAL_CLOCK_10MHZ_REF](#) clock source, the decimation value must be 1, 2, 4 or any multiple of 10. Note that the sample rate identifier value must be 500000000, and the sample rate will be 500 MHz divided by the decimation value.
- If an ATS9870 is configured to use an [EXTERNAL_CLOCK_10MHZ_REF](#) clock source, the decimation value must be 1, 2, 4 or any multiple of 10. Note that the sample rate identifier value must be 1000000000, and the sample rate will be 1 GHz divided by the decimation value.

Returns

ApiSuccess upon success, or an error code. See [RETURN_CODE](#) for more detailed information.

Parameters

- handle – **[in]** Board handle

- source – **[in]** Clock source identifiers. Must be a member of [ALAZAR_CLOCK_SOURCES](#). See board-specific information for a list of valid values for each board. For external clock types, the identifier to choose may depend on the clock’s frequency. See board-specific information for a list of frequency ranges for all clock types.
- sampleRateIdOrValue – **[in]** If the clock source chosen is [INTERNAL_CLOCK](#), this value is a member of [ALAZAR_SAMPLE_RATES](#) that defines the internal sample rate to choose. Valid values for each board vary. If the clock source chosen is [EXTERNAL_CLOCK_10MHZ_REF](#), pass the value of the sample clock to generate from the reference in hertz. The values that can be generated depend on the board model. Otherwise, the clock source is external, pass [SAMPLE_RATE_USER_DEF](#) to this parameter.
- edgeId – **[in]** The external clock edge on which to latch sample rate. Must be a member of [ALAZAR_CLOCK_EDGES](#).
- decimation – **[in]** Decimation value. May be an integer between 0 and 100000 with the following exceptions. Note that a decimation value of 0 means disable decimation.

6.84.2 LabVIEW Block Diagram

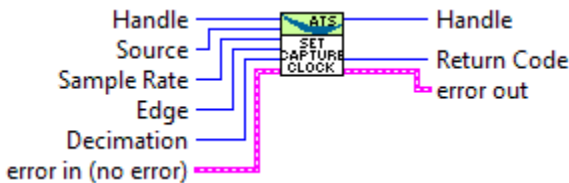

6.84.3 Related Enumerations

enum ALAZAR_CLOCK_SOURCES

Clock source identifiers.

Values:

enumerator INTERNAL_CLOCK

0x00000001UL Internal clock

enumerator EXTERNAL_CLOCK

0x00000002UL External clock

enumerator FAST_EXTERNAL_CLOCK

0x00000002UL Fast external clock

enumerator MEDIUM_EXTERNAL_CLOCK
0x00000003UL Medium external clock

enumerator SLOW_EXTERNAL_CLOCK
0x00000004UL Slow external clock

enumerator EXTERNAL_CLOCK_AC
0x00000005UL AC external clock

enumerator EXTERNAL_CLOCK_DC
0x00000006UL DC external clock

enumerator EXTERNAL_CLOCK_10MHZ_REF
0x00000007UL 10MHz external reference

enumerator INTERNAL_CLOCK_10MHZ_REF
0x00000008 Internal 10MHz reference

enumerator EXTERNAL_CLOCK_10MHZ_PXI
0x0000000A External 10MHz PXI

enum ALAZAR_SAMPLE_RATES
Sample rate identifiers.

Values:

enumerator SAMPLE_RATE_1KSPS
0x00000001UL

enumerator SAMPLE_RATE_2KSPS
0x00000002UL

enumerator SAMPLE_RATE_5KSPS
0x00000004UL

enumerator SAMPLE_RATE_10KSPS
0x00000008UL

enumerator SAMPLE_RATE_20KSPS
0x0000000AUL

enumerator SAMPLE_RATE_50KSPS
0X0000000CUL

enumerator SAMPLE_RATE_100KSPS
0X0000000EUL

enumerator SAMPLE_RATE_200KSPS
0X00000010UL

enumerator SAMPLE_RATE_500KSPS
0X00000012UL

enumerator SAMPLE_RATE_1MSPS
0X00000014UL

enumerator SAMPLE_RATE_2MSPS
0X00000018UL

enumerator SAMPLE_RATE_5MSPS
0X0000001AUL

enumerator SAMPLE_RATE_10MSPS
0X0000001CUL

enumerator SAMPLE_RATE_20MSPS
0X0000001EUL

enumerator SAMPLE_RATE_25MSPS
0X00000021UL

enumerator SAMPLE_RATE_50MSPS
0X00000022UL

enumerator SAMPLE_RATE_100MSPS
0X00000024UL

enumerator SAMPLE_RATE_125MSPS
0x00000025UL

enumerator SAMPLE_RATE_160MSPS
0x00000026UL

enumerator SAMPLE_RATE_180MSPS
0x00000027UL

enumerator SAMPLE_RATE_200MSPS
0X00000028UL

enumerator SAMPLE_RATE_250MSPS
0X0000002BUL

enumerator SAMPLE_RATE_400MSPS
0X0000002DUL

enumerator SAMPLE_RATE_500MSPS
0X00000030UL

enumerator SAMPLE_RATE_800MSPS
0X00000032UL

enumerator SAMPLE_RATE_1000MSPS
0x00000035UL

enumerator SAMPLE_RATE_1GSPS
0x00000035UL

enumerator SAMPLE_RATE_1200MSPS
0x00000037UL

enumerator SAMPLE_RATE_1500MSPS
0x0000003AUL

enumerator SAMPLE_RATE_1600MSPS
0x0000003BUL

enumerator SAMPLE_RATE_1800MSPS
0x0000003DUL

enumerator SAMPLE_RATE_2000MSPS
0x0000003FUL

enumerator SAMPLE_RATE_2GSPS
0x0000003FUL

enumerator SAMPLE_RATE_2400MSPS
0x0000006AUL

enumerator SAMPLE_RATE_3000MSPS
0x00000075UL

enumerator SAMPLE_RATE_3GSPS
0x00000075UL

enumerator SAMPLE_RATE_3600MSPS
0x0000007BUL

enumerator SAMPLE_RATE_4000MSPS
0x00000080UL

enumerator SAMPLE_RATE_4GSPS
0x00000080UL

enumerator SAMPLE_RATE_300MSPS
0x00000090UL

enumerator SAMPLE_RATE_350MSPS
0x00000094UL

enumerator SAMPLE_RATE_370MSPS
0x00000096UL

enumerator SAMPLE_RATE_5000MSPS
0x000000A0UL

enumerator SAMPLE_RATE_5GSPS
0x000000A0UL

enumerator SAMPLE_RATE_10000MSPS
0x000000B0UL

enumerator SAMPLE_RATE_10GSPS
0x000000B0UL

enumerator SAMPLE_RATE_1333MSPS_RECUR_DECIMAL
0x000000C0UL

enumerator SAMPLE_RATE_2666MSPS_RECUR_DECIMAL
0x000000C1UL

enumerator SAMPLE_RATE_USER_DEF
User-defined sample rate. Used with external clock.
0x00000040UL

enum ALAZAR_CLOCK_EDGES
Clock edge identifiers.
Values:

enumerator CLOCK_EDGE_RISING
0x00000000UL Rising clock edge

enumerator CLOCK_EDGE_FALLING
0x00000001UL Falling clock edge

6.85 AlazarSetExternalClockLevel

6.85.1 Function Syntax

RETURN_CODE AlazarSetExternalClockLevel(HANDLE handle, float level_percent)
Set the external clock comparator level.

Remark

Only the following boards support this feature: ATS460, ATS660, ATS860, ATS9350, ATS9351, ATS9352, ATS9353, ATS9440, ATS9462, ATS9625, ATS9626, ATS9870, ATS9872, ATS9874.

Parameters

- handle – **[in]** Board handle
- level_percent – **[in]** The external clock comparator level, in percent.

Returns

ApiSuccess upon success, or an error code. See *RETURN_CODE* for more detailed information.

6.85.2 LabVIEW Block Diagram



6.86 AlazarSetExternalTrigger

6.86.1 Function Syntax

RETURN_CODE AlazarSetExternalTrigger(HANDLE handle, U32 couplingId, U32 rangeId)
Set the external trigger range and coupling.

Parameters

- handle – **[in]** Board handle
- couplingId – **[in]** Specifies the external trigger coupling. See [ALAZAR_COUPLINGS](#) for existing values. Consult board-specific information to see which values are supported by each board.
- rangeId – **[in]** Specifies the external trigger range. See [ALAZAR_EXTERNAL_TRIGGER_RANGES](#) for a list of all existing values. Consult board-specific information to see which values are supported by each board.

6.86.2 LabVIEW Block Diagram

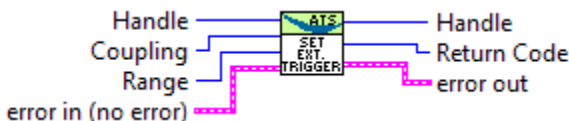

6.86.3 Related Enumerations

enum ALAZAR_EXTERNAL_TRIGGER_RANGES
External trigger range identifiers.

Values:

enumerator ETR_5V_50OHM
0x00000000UL 5V-50OHM range

enumerator ETR_1V_50OHM
0x00000001UL 1V-50OHM range

enumerator ETR_TTL

0x00000002UL TTL range

enumerator ETR_2V5_50OHM

0x00000003UL 2V5-50OHM range

enumerator ETR_5V_300OHM

0x00000004UL 5V-300OHM range

6.87 AlazarSetLED

6.87.1 Function Syntax

RETURN_CODE AlazarSetLED(HANDLE handle, U32 state)

Control the LED on a board's mounting bracket.

Parameters

- handle – **[in]** Board handle
- state – **[in]** to put the LED in. Must be a member of [ALAZAR_LED](#)

Returns

ApiSuccess upon success, or an error code. See [RETURN_CODE](#) for more detailed information.

6.87.2 LabVIEW Block Diagram

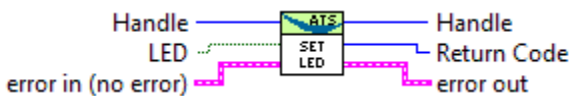

6.87.3 Related Enumerations

enum ALAZAR_LED

LED state identifiers.

Values:

enumerator LED_OFF

0x00000000UL OFF LED

enumerator LED_ON
0x00000001UL ON LED

6.88 AlazarSetParameter

6.88.1 Function Syntax

RETURN_CODE AlazarSetParameter(HANDLE handle, U8 channel, U32 parameter, long value)

Set a device parameter as a signed long value.

Parameters

- handle – **[in]** Board handle
- channel – **[in]** The channel to control. See [ALAZAR_CHANNELS](#) for a list of possible values. This parameter only takes unsigned 8-bit values.
- parameter – **[in]** The Parameter to modify. This can be one of [ALAZAR_PARAMETERS](#).
- value – **[in]** Parameter value

Returns

ApiSuccess upon success, or an error code. See [RETURN_CODE](#) for more detailed information.

6.89 AlazarSetParameterLL

6.89.1 Function Syntax

RETURN_CODE AlazarSetParameterLL(HANDLE handle, U8 channel, U32 parameter, S64 value)

Set a device parameter as a long long value.

Parameters

- handle – **[in]** Board handle
- channel – **[in]** The channel to control. See [ALAZAR_CHANNELS](#) for a list of possible values. This parameter only takes unsigned 8-bit values.
- parameter – **[in]** The Parameter to modify. This can be one of [ALAZAR_PARAMETERS](#).
- value – **[in]** Parameter value

Returns

ApiSuccess upon success, or an error code. See [RETURN_CODE](#) for more detailed information.

6.90 AlazarSetParameterUL

6.90.1 Function Syntax

[RETURN_CODE](#) AlazarSetParameterUL (HANDLE handle, U8 channel, U32 parameter, U32 value)

Set a device parameter as an unsigned long value.

Parameters

- handle – **[in]** Board handle
- channel – **[in]** The channel to control. See [ALAZAR_CHANNELS](#) for a list of possible values. This parameter only takes unsigned 8-bit values.
- parameter – **[in]** The Parameter to modify. This can be one of [ALAZAR_PARAMETERS_UL](#).
- value – **[in]** Parameter value. See [ALAZAR_PARAMETERS_UL](#) for details about valid values

Returns

ApiSuccess upon success, or an error code. See [RETURN_CODE](#) for more detailed information.

6.90.2 LabVIEW Block Diagram

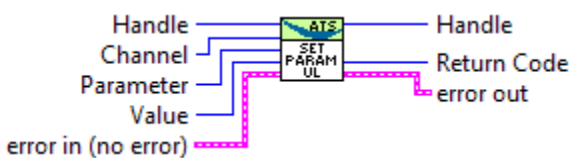

6.91 AlazarSetRecordCount

6.91.1 Function Syntax

[RETURN_CODE](#) AlazarSetRecordCount (HANDLE handle, U32 Count)

Select the number of records to capture to on-board memory.

Remark

The maximum number of records per capture is a function of the board type, the maximum number of samples per channel (SPC), and the current number of samples per record (SPR) :

- ATS850, ATS310, ATS330 : $\min(\text{SPC} / (\text{SPR} + 16), 10000)$
- ATS460, ATS660, ATS9462 : $\min(\text{SPC} / (\text{SPR} + 16), 256000)$
- ATS860, ATS9325, ATS935X : $\min(\text{SPC} / (\text{SPR} + 32), 256000)$
- ATS9850, ATS9870 : $\min(\text{SPC} / (\text{SPR} + 64), 256000)$

Note: This function is part of the single-port API, and cannot be used in a dual-port context.

Parameters

- handle – **[in]** Board handle
- Count – **[in]** The number of records to acquire to on-board memory during the acquisition.

Returns

ApiSuccess upon success, or an error code. See [RETURN_CODE](#) for more detailed information.

6.91.2 LabVIEW Block Diagram

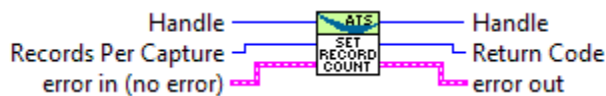

6.92 AlazarSetRecordSize

6.92.1 Function Syntax

RETURN_CODE AlazarSetRecordSize(HANDLE handle, U32 preTriggerSamples, U32 postTriggerSamples)

Set the number of pre-trigger and post-trigger samples per record.

Remark

The number of pre-trigger samples must not exceed the number of samples per record minus 64.

Remark

The number of samples per record is the sum of the pre- and post-trigger samples. It must follow requirements specific to each board listed in the board-specific documentation.

Parameters

- handle – **[in]** Board handle
- preTriggerSamples – **[in]** Number of samples before the trigger position in each record.
- postTriggerSamples – **[in]** Number of samples after the trigger position in each record.

Returns

ApiSuccess upon success, or an error code. See [RETURN_CODE](#) for more detailed information.

6.92.2 LabVIEW Block Diagram

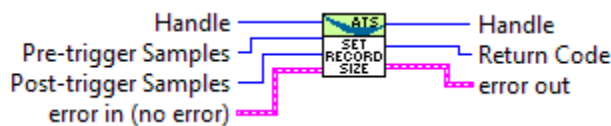

6.93 AlazarSetTriggerDelay

6.93.1 Function Syntax

[RETURN_CODE](#) AlazarSetTriggerDelay(HANDLE handle, U32 Delay)

Set the time, in sample clocks, to wait after receiving a trigger event before capturing a record for the trigger.

Parameters

- handle – **[in]** Board handle
- Delay – **[in]** Trigger delay in sample clocks. Must be a value between 0 and 9 999 999. It must also be a multiple of a certain value that varies from one board to another. See board-specific information to know which multiplier must be respected.

Returns

ApiSuccess upon success, or an error code. See [RETURN_CODE](#) for more detailed information.

6.93.2 LabVIEW Block Diagram



6.94 AlazarSetTriggerOperation

6.94.1 Function Syntax

RETURN_CODE AlazarSetTriggerOperation(HANDLE handle, U32 TriggerOperation, U32 TriggerEngine1, U32 Source1, U32 Slope1, U32 Level1, U32 TriggerEngine2, U32 Source2, U32 Slope2, U32 Level2)

Configures the trigger system.

Remark

The trigger level is specified as an unsigned 8-bit code that represents a fraction of the full scale input voltage of the trigger source: 0 represents the negative limit, 128 represents the 0 level, and 255 represents the positive limit. For example, if the trigger source is CH A, and the CH A input range is ± 800 mV, then 0 represents a -800 mV trigger level, 128 represents a 0 V trigger level, and 255 represents $+800$ mV trigger level.

Remark

If the trigger source is external, the full scale input voltage for the external trigger connector is dictated by the [AlazarSetExternalTrigger\(\)](#) function.

Remark

All PCI Express boards except ATS9462 support only one external trigger level. If both Source1 and Source2 are set to [TRIG_EXTERNAL](#) of [ALAZAR_TRIGGER_SOURCES](#), Level1 is ignored and only Level2 is used. All other boards support using different values for the two levels.

Parameters

- handle – **[in]** Board handle
- TriggerOperation – **[in]** Specify how the two independent trigger engines generate a trigger. This can be one of [ALAZAR_TRIGGER_OPERATIONS](#)
- TriggerEngine1 – **[in]** First trigger engine to configure. Can be one of [ALAZAR_TRIGGER_ENGINES](#).
- Source1 – **[in]** Signal source for the first trigger engine. Can be one of [ALAZAR_TRIGGER_SOURCES](#).

- Slope1 – **[in]** Sign Direction of the trigger voltage slope that will generate a trigger event for the first engine. Can be one of [ALAZAR_TRIGGER_SLOPES](#).
- Level1 – **[in]** Select the voltage level that the trigger signal must cross to generate a trigger event.
- TriggerEngine2 – **[in]** Second trigger engine to configure. Can be one of [ALAZAR_TRIGGER_ENGINES](#).
- Source2 – **[in]** Signal source for the second trigger engine. Can be one of [ALAZAR_TRIGGER_SOURCES](#).
- Slope2 – **[in]** Sign Direction of the trigger voltage slope that will generate a trigger event for the second engine. Can be one of [ALAZAR_TRIGGER_SLOPES](#).
- Level2 – **[in]** Select the voltage level that the trigger signal must cross to generate a trigger event.

Returns

ApiSuccess upon success, or an error code. See [RETURN_CODE](#) for more detailed information.

6.94.2 LabVIEW Block Diagram

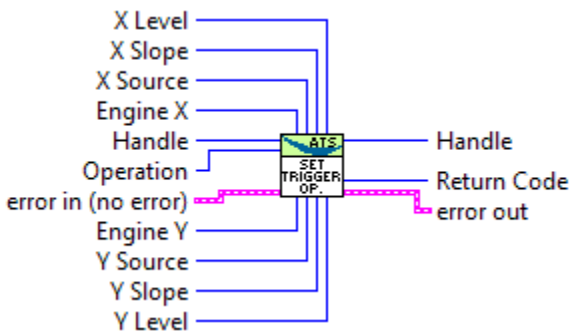

6.94.3 Related Enumerations

enum ALAZAR_TRIGGER_OPERATIONS

Trigger operation identifiers.

Values:

enumerator TRIG_ENGINE_OP_J

0x00000000UL The board triggers when a trigger event is detected by trigger engine J. Events detected by engine K are ignored.

enumerator TRIG_ENGINE_OP_K

0x00000001UL The board triggers when a trigger event is detected by trigger engine K. Events detected by engine J are ignored.

enumerator TRIG_ENGINE_OP_J_OR_K

0x00000002UL The board triggers when a trigger event is detected by any of the J and K trigger engines.

enumerator TRIG_ENGINE_OP_J_AND_K

0x00000003UL This value is deprecated. It cannot be used.

enumerator TRIG_ENGINE_OP_J_XOR_K

0x00000004UL This value is deprecated. It cannot be used.

enumerator TRIG_ENGINE_OP_J_AND_NOT_K

0x00000005UL This value is deprecated. It cannot be used.

enumerator TRIG_ENGINE_OP_NOT_J_AND_K

0x00000006UL This value is deprecated. It cannot be used.

enum ALAZAR_TRIGGER_ENGINES

Trigger engine identifiers.

Values:

enumerator TRIG_ENGINE_J

0x00000000UL The J trigger engine

enumerator TRIG_ENGINE_K

0x00000001UL The K trigger engine

enum ALAZAR_TRIGGER_SOURCES

Trigger sources.

Values:

enumerator TRIG_CHAN_A

0x00000000UL Channel A

enumerator TRIG_CHAN_B

0x00000001UL Channel B

enumerator TRIG_EXTERNAL
0x00000002UL External trigger source

enumerator TRIG_DISABLE
0x00000003UL Disabled trigger

enumerator TRIG_CHAN_C
0x00000004UL Channel C

enumerator TRIG_CHAN_D
0x00000005UL Channel D

enumerator TRIG_CHAN_E
0x00000006UL Channel E

enumerator TRIG_CHAN_F
0x00000007UL Channel F

enumerator TRIG_CHAN_G
0x00000008UL Channel G

enumerator TRIG_CHAN_H
0x00000009UL Channel H

enumerator TRIG_CHAN_I
0x0000000AUL Channel I

enumerator TRIG_CHAN_J
0x0000000BUL Channel J

enumerator TRIG_CHAN_K
0x0000000CUL Channel K

enumerator TRIG_CHAN_L
0x0000000DUL Channel L

enumerator TRIG_CHAN_M
0x0000000EUL Channel M

enumerator TRIG_CHAN_N
0x0000000FUL Channel N

enumerator TRIG_CHAN_O
0x00000010UL Channel O

enumerator TRIG_CHAN_P
0x00000011UL Channel P

enum ALAZAR_TRIGGER_SLOPES
Trigger slope identifiers.

These identifiers select whether rising or falling edges of the trigger source signal are detected as trigger events.

Values:

enumerator TRIGGER_SLOPE_POSITIVE
0x00000001UL The trigger engine detects a trigger event when sample values from the trigger source rise above a specified level.

enumerator TRIGGER_SLOPE_NEGATIVE
0x00000002UL The trigger engine detects a trigger event when sample values from the trigger source fall below a specified level.

6.95 AlazarSetTriggerOperationForScanning

6.95.1 Function Syntax

RETURN_CODE AlazarSetTriggerOperationForScanning(HANDLE handle, U32 slopeId, U32 level, U32 options)

Configure the trigger engines of a board to use an external trigger input and, optionally, synchronize the start of an acquisition with the next external trigger event after [AlazarStartCapture\(\)](#) is called.

Remark

[AlazarSetTriggerOperationForScanning\(\)](#) is intended for scanning applications that supply both external clock and external trigger signals to the digitizer, where the external clock is not suitable to drive the digitizer in between trigger events.

Remark

This function configures a board to use trigger operation TRIG_ENGINE_OP_J, and the source of TRIG_ENGINE_J to be TRIG_EXTERNAL. The application must call [AlazarSetExternalTrigger\(\)](#) to set the full-scale external input range and coupling of the external trigger signal connected to the TRIG IN connector. An application should call [AlazarSetTriggerOperationForScanning\(\)](#) or [AlazarSetTriggerOperation\(\)](#), but not both.

Remark

The trigger level is specified as an unsigned 8-bit code that represents a fraction of the full scale input voltage of the external trigger range: 0 represents the negative limit, 128 represents the 0 level, and 255 represents the positive limit.

Remark

[AlazarSetTriggerOperationForScanning\(\)](#) is currently only supported on AT9462 with FPGA 35.0 or later.

Parameters

- handle – **[in]** Board handle
- slopeId – **[in]** Select the direction of the rate of change of the external trigger signal when it crosses the trigger voltage level that is required to generate a trigger event. Must be an element of [ALAZAR_TRIGGER_SLOPES](#).
- level – **[in]** Specify a trigger level code representing the trigger level in volts that an external trigger signal connected must pass through to generate a trigger event. See the Remarks section below.
- options – **[in]** The options parameter may be one of [ALAZAR_STOS_OPTIONS](#)

Returns

[ApiSuccess](#) upon success, or an error code. See [RETURN_CODE](#) for more detailed information.

6.95.2 Related Enumerations

enum ALAZAR_STOS_OPTIONS

Options for AlazarSetExternalTriggerOperationForScanning()

Values:

enumerator STOS_OPTION_DEFER_START_CAPTURE

1

6.96 AlazarSetTriggerTimeout

6.96.1 Function Syntax

[RETURN_CODE](#) AlazarSetTriggerTimeout(HANDLE handle, U32 timeout_ticks)

Set the time to wait for a trigger event before automatically generating a trigger event.

Parameters

- handle – **[in]** Board handle
- timeout_ticks – **[in]** The trigger timeout value in ticks. Tick are 10 μ s for all boards, except for ATS9416 where they are 5 μ s. Pass 0 to make the board wait forever for a trigger event.

Returns

ApiSuccess upon success, or an error code. See [RETURN_CODE](#) for more detailed information.

6.96.2 LabVIEW Block Diagram



6.97 AlazarSleepDevice

6.97.1 Function Syntax

[RETURN_CODE](#) AlazarSleepDevice(HANDLE handle, U32 sleepState)

Control power to ADC devices.

Parameters

- handle – **[in]** Handle to board
- sleepState – **[in]** Specifies the power state of the ADC converters. This paramter can be one of [ALAZAR_POWER_STATES](#).

6.97.2 Related Enumerations

```
enum ALAZAR_POWER_STATES
```

Power states.

Values:

```
enumerator POWER_OFF
```

```
0x00000000UL OFF
```

```
enumerator POWER_ON
```

```
0x00000001UL ON
```

6.98 AlazarStartCapture

6.98.1 Function Syntax

RETURN_CODE AlazarStartCapture(HANDLE handle)

Arm a board to start an acquisition.

Remark

Only call on the master board in a master-slave system.

Returns

ApiSuccess upon success, or an error code. See *RETURN_CODE* for more detailed information.

6.98.2 LabVIEW Block Diagram



6.99 AlazarTriggered

6.99.1 Function Syntax

U32 AlazarTriggered(HANDLE handle)

Determine if a board has triggered during the current acquisition.

Note: This function is part of the single-port data acquisition API. It cannot be used with the dual-port AutoDMA APIs.

Parameters

- handle – **[in]** Board handle

Returns

If the board has received at least one trigger event since the last call to *AlazarStartCapture()*, this function returns 1. Otherwise, it returns 0.

6.99.2 LabVIEW Block Diagram

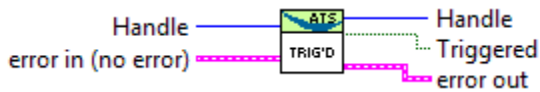

6.100 AlazarWaitAsyncBufferComplete

6.100.1 Function Syntax

RETURN_CODE AlazarWaitAsyncBufferComplete(HANDLE handle, void *buffer, U32 timeout_ms)

This function returns when a board has received sufficient triggers to fill the specified buffer, or when the timeout interval elapses.

Each call to *AlazarPostAsyncBuffer()* adds a buffer to the end of a list of buffers to be filled by the board. *AlazarWaitAsyncBufferComplete()* expects to wait on the buffer at the head of this list. As a result, you must wait for buffers in the same order than they were posted.

Remark

You must call *AlazarBeforeAsyncRead()* and *AlazarPostAsyncBuffer()* before calling *AlazarWaitAsyncBufferComplete()*.

When *AlazarWaitAsyncBufferComplete()* returns *ApiSuccess*, the buffer is removed from the list of buffers to be filled by the board.

The arrangement of sample data in each buffer depends on the AutoDMA mode specified in the call to *AlazarBeforeAsyncRead()*.

Warning: You must call *AlazarAbortAsyncRead()* before your application exits if you have called *AlazarPostAsyncBuffer()* and buffers are pending.

Parameters

- handle – **[in]** Handle to board
- buffer – **[out]** Pointer to a buffer to receive sample data from the digitizer board
- timeout_ms – **[in]** The time to wait for the buffer to be filled, in milliseconds.

Returns

If the board receives sufficient trigger events to fill this buffer before the timeout interval elapses, the function returns *ApiSuccess*.

Returns

If the timeout interval elapses before the board receives sufficient trigger events to fill the buffer, the function returns *ApiWaitTimeout*.

Returns

If the board overflows its on-board memory, the function returns *ApiBufferOverflow*. This happens if the rate at which data is acquired is faster than the rate at which data is being transferred from on-board memory to host memory across the host bus interface.

Returns

If this buffer was not found in the list of buffers available to be filled by the board, the function returns *ApiBufferNotReady*.

Returns

If this buffer is not the buffer at the head of the list of buffers to be filled by the board, this returns *ApiDmaInProgress*.

Returns

If the function fails for some other reason, it returns an error code that indicates the reason that it failed. See *RETURN_CODE* for more information.

6.101 AlazarWaitNextAsyncBufferComplete

6.101.1 Function Syntax

RETURN_CODE AlazarWaitNextAsyncBufferComplete(HANDLE handle, void *buffer, U32 bytesToCopy, U32 timeout_ms)

This function returns when the board has received sufficient trigger events to fill the buffer, or the timeout interval has elapsed.

To use this function, *AlazarBeforeAsyncRead()* must be called with *ADMA_ALLOC_BUFFERS*.

You must call *AlazarBeforeAsyncRead()* with the *ADMA_GET_PROCESSED_DATA* flag before calling *AlazarWaitNextAsyncBufferComplete()*.

To discard buffers, set the bytesToCopy parameter to zero. This will cause *AlazarWaitNextAsyncBufferComplete()* to wait for a buffer to complete, but not copy any data into the application buffer.

To enable disk streaming using high-performance disk I/O functions, call *AlazarCreateStreamFile()* before calling *AlazarWaitNextAsyncBufferComplete()*. For best performance, set the bytesToCopy parameter to zero so that data is streamed to disk without making any intermediate copies in memory.

AlazarBeforeAsyncRead() can be called with the *ADMA_GET_PROCESSED_DATA* flag. In this case, *AlazarWaitNextAsyncBufferComplete()* will process buffers so that the

data layout is always not interleaved (i.e. R1A, R2A, ... RnA, R1B, R2B, ... RnB with RXY record X of channel Y). This may simplify application development, but it comes at the expense of added processing time for each buffer.

Parameters

- `handle` – **[in]** Handle to board
- `buffer` – **[out]** Pointer to a buffer to receive sample data from the digitizer board.
- `bytesToCopy` – **[in]** The number of bytes to copy into the buffer
- `timeout_ms` – **[in]** The time to wait for the buffer to buffer to be filled, in milliseconds.

Returns

If the board receives sufficient trigger events to fill the next available buffer before the timeout interval elapses, and the buffer is not the last buffer in the acquisition, the function returns *ApiSuccess*.

Returns

If the board receives sufficient trigger events to fill the next available buffer before the timeout interval elapses, and the buffer is the last buffer in the acquisition, the function returns *ApiTransferComplete*.

Returns

If the timeout interval elapses before the board receives sufficient trigger events to fill the next available buffer, the function returns *ApiWaitTimeout*.

Returns

If the board overflows its on-board memory, the function returns *ApiBufferOverflow*. The board may overflow its on-board memory because the rate at which it is acquiring data is faster than the rate at which the data is being transferred from on-board memory to host memory across the host bus interface (PCI or PCIe). If this is the case, try reducing the sample rate, number of enabled channels, or amount of time spent processing each buffer.

Returns

If the function fails for some other reason, it returns an error code that indicates the reason that it failed.

6.101.2 LabVIEW Block Diagram

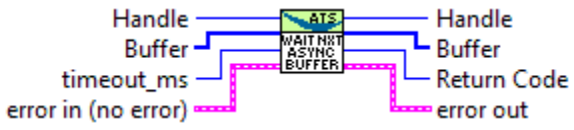

BOARD-SPECIFIC INFORMATION

7.1 Supported impedances and input ranges

ATS310/50Ω, ATS330/50Ω, ATS9120/50Ω, ATS9130/50Ω

±40mV, ±50mV, ±80mV, ±100mV, ±200mV, ±400mV, ±500mV, ±800mV, ±1V, ±2V, ±4V

ATS310/1MΩ, ATS330/1MΩ, ATS9120/1MΩ, ATS9130/1MΩ

±40mV, ±50mV, ±80mV, ±100mV, ±200mV, ±400mV, ±500mV, ±800mV, ±1V, ±2V, ±4V, ±5V, ±8V, ±10V, ±20V

ATS460/50Ω, ATS9146/50Ω, ATS9182/50Ω

±20mV, ±40mV, ±50mV, ±80mV, ±100mV, ±200mV, ±400mV, ±500mV, ±800mV, ±1V, ±2V, ±4V

ATS460/1MΩ, ATS9146/1MΩ, ATS9182/1MΩ

±20mV, ±40mV, ±50mV, ±80mV, ±100mV, ±200mV, ±400mV, ±500mV, ±800mV, ±1V, ±2V, ±4V, ±5V, ±8V, ±10V

ATS660/50Ω, ATS9462/50Ω

±200mV, ±400mV, ±800mV, ±2V, ±4V

ATS660/1MΩ, ATS9462/1MΩ

±200mV, ±400mV, ±800mV, ±2V, ±4V, ±8V, ±16V

ATS850/50Ω

±40mV, ±50mV, ±80mV, ±100mV, ±200mV, ±400mV, ±500mV, ±800mV, ±1V, ±2V, ±4V

ATS850/1MΩ

±20mV, ±40mV, ±50mV, ±80mV, ±100mV, ±200mV, ±400mV, ±500mV, ±800mV, ±1V, ±2V, ±4V, ±5V, ±8V, ±10V

ATS860/50Ω

±20mV, ±40mV, ±50mV, ±80mV, ±100mV, ±200mV, ±400mV, ±500mV, ±800mV, ±1V, ±2V, ±4V

ATS860/1MΩ

±20mV, ±40mV, ±50mV, ±80mV, ±100mV, ±200mV, ±400mV, ±500mV, ±800mV, ±1V, ±2V, ±4V, ±5V, ±8V, ±10V

**ATS9325/50Ω, ATS9350/50Ω, ATS9850/50Ω, ATS9870/50Ω, ATS9872/50Ω, AXI9870/50Ω,
ATS9352/50Ω**
±40mV, ±100mV, ±200mV, ±400mV, ±1V, ±2V, ±4V

ATS9352/50Ω
±100mV, ±200mV, ±400mV, ±1V, ±2V, ±4V

**ATS9351/50Ω, ATS9353/50Ω, ATS9360/50Ω, ATS9370/50Ω, ATS9371/50Ω, ATS9373/50Ω,
ATS9364/50Ω**
±400mV

ATS9625/50Ω, ATS9626/50Ω, ATS9628/50Ω, ATS9428/50Ω
±1.25V

ATS9440/50Ω
±100mV, ±200mV, ±400mV, ±1V, ±2V, ±4V

ATS9416/50Ω
±1V

ATS9874/50Ω
±500mV

ATS9470/50Ω, ATS9473/50Ω
±560mV

7.2 Samples per record requirements

It is required for the value of samples per record to be above or equal to a given minimum and to be a multiple of a certain value. These two requirements differ from board to board. The following table lists the limits for all boards.

In addition, the number of pre-trigger samples for each board must be a multiple of a given value.

Board type	Min. size	record	Pretrig. alignment	align-	Resolu- tion	Max length	NPT	pretrig.
ATS310, ATS330	256		4		16			
ATS460, ATS660	128		16		16			
ATS850	256		4		16			
ATS860	256		32		32			
ATS9350, ATS9351	256		32		32	4080		
ATS9120, ATS9130	256		32		32	4080		
ATS9146	256		32		32	4080		
ATS9182	512		64		64	8160		
ATS9360, ATS9370	256		128		128	8176		
ATS9371, ATS9373	256		128		128	8176		
ATS9416	256		128		128	8176		
ATS9440, ATS9462	256		32		32	2032		
ATS9625, ATS9626	256		32		32	4080		
ATS9870, AXI9870	256		64		64			
ATS9352, ATS9353	256		32		32	4080		
ATS9872, ATS9874	512		64		64	8160		
ATS9628, ATS9428	256		32		32	4080		
ATS9364	256		128		128	8176		
ATS9470, ATS9473	256		128		128	4080		

7.3 Samples per timestamp and trigger delay alignment

Numbers in this table correspond to:

- The ratio between timestamp units and sample clocks in traditional record headers.
- The trigger delay value alignment requirement

Board	Active Channels				
	1 ch.	2 ch.	4 ch.	8 ch.	16 ch.
ATS310	2	1			
ATS330	2	1			
ATS460	2	1			
ATS660	2	1			
ATS850	2	1			
ATS860	4	2	1		
ATS9120	8	4			
ATS9130	8	4			
ATS9146	8	4			
ATS9350	8	4			
ATS9351	8	4			
ATS9360	16	8			
ATS9370	16	8			
ATS9371	16	8			
ATS9373	16	8			
ATS9416	16	8	4	2	1
ATS9440	4	2	1		
ATS9462	2	1			
ATS9625	2	1			
ATS9626	2	1			
ATS9870	16	8			
AXI9870	16	8			
ATS9352	8	4			
ATS9353	8	4			
ATS9872	4	4			
ATS9628	4	4			
ATS9428	4	4			
ATS9364	16	8			
ATS9182	8	4			
ATS9874	4	4			

7.4 Aux I/O output Synchronization

When used as an output, the AUX I/O works on a clock that is generally slower than the sample clock. The ratio between the AUX I/O clock and the sample clock depends on the board and on the number of active channels. For all boards except ATS9360, ATS9371, ATS9373 and ATS9416, the ratio is the same as that specified in [Samples per timestamp and trigger delay alignment](#). For ATS9360, ATS9371, ATS9373 and ATS9416, the AUX I/O is driven by a free running clock of a frequency of 260 MHz. Please note that the frequency of this clock may change from one board to another and from one firmware version to another.

7.5 Possible input channel configurations

Channels	Channels per board		
	2	4	16
A	✓	✓	✓
B	✓	✓	✓
A + B	✓	✓	✓
C		✓	✓
A + C		✓	
B + C		✓	
D		✓	✓
A + D		✓	
B + D		✓	
C + D		✓	
A + .. + D		✓	✓
E			✓
F			✓
G			✓
H			✓
A + .. + H			✓
I			✓
J			✓
K			✓
L			✓
M			✓
N			✓
O			✓
P			✓
A + .. + P			✓

7.6 Supported sample rates

ATS310, ATS9120

10kS/s, 20kS/s, 50kS/s, 100kS/s, 200kS/s, 500kS/s, 1MS/s, 2MS/s, 5MS/s, 10MS/s, 20MS/s

ATS330, ATS9130

10kS/s, 20kS/s, 50kS/s, 100kS/s, 200kS/s, 500kS/s, 1MS/s, 2MS/s, 5MS/s, 10MS/s, 25MS/s, 50MS/s

ATS460, ATS660, ATS9146

1kS/s, 2kS/s, 5kS/s, 10kS/s, 20kS/s, 50kS/s, 100kS/s, 200kS/s, 500kS/s, 1MS/s, 2MS/s, 5MS/s, 10MS/s, 20MS/s, 50MS/s, 100MS/s, 125MS/s

ATS850

10kS/s, 20kS/s, 50kS/s, 100kS/s, 200kS/s, 500kS/s, 1MS/s, 2MS/s, 5MS/s, 10MS/s, 25MS/s,

50MS/s

ATS860, ATS9182

1kS/s, 2kS/s, 5kS/s, 10kS/s, 20kS/s, 50kS/s, 100kS/s, 200kS/s, 500kS/s, 1MS/s, 2MS/s, 5MS/s, 10MS/s, 25MS/s, 50MS/s, 100MS/s, 125MS/s, 250MS/s

ATS9350, ATS9351

1kS/s, 2kS/s, 5kS/s, 10kS/s, 20kS/s, 50kS/s, 100kS/s, 200kS/s, 500kS/s, 1MS/s, 2MS/s, 5MS/s, 10MS/s, 20MS/s, 50MS/s, 100MS/s, 125MS/s, 250MS/s, 500MS/s

ATS9360

1kS/s, 2kS/s, 5kS/s, 10kS/s, 20kS/s, 50kS/s, 100kS/s, 200kS/s, 500kS/s, 1MS/s, 2MS/s, 5MS/s, 10MS/s, 20MS/s, 50MS/s, 100MS/s, 200MS/s, 500MS/s, 800MS/s, 1000MS/s, 1200MS/s, 1500MS/s, 1800MS/s

ATS9371, ATS9364

1kS/s, 2kS/s, 5kS/s, 10kS/s, 20kS/s, 50kS/s, 100kS/s, 200kS/s, 500kS/s, 1MS/s, 2MS/s, 5MS/s, 10MS/s, 20MS/s, 50MS/s, 100MS/s, 200MS/s, 500MS/s, 800MS/s, 1000MS/s

ATS9373

1kS/s, 2kS/s, 5kS/s, 10kS/s, 20kS/s, 50kS/s, 100kS/s, 200kS/s, 500kS/s, 1MS/s, 2MS/s, 5MS/s, 10MS/s, 20MS/s, 50MS/s, 100MS/s, 200MS/s, 500MS/s, 800MS/s, 1000MS/s, 1200MS/s, 1500MS/s, 2000MS/s, 2400MS/s, 3000MS/s, 3600MS/s, 4000MS/s

ATS9416

1MS/s, 2MS/s, 5MS/s, 10MS/s, 20MS/s, 50MS/s, 100MS/s

ATS9440

1kS/s, 2kS/s, 5kS/s, 10kS/s, 20kS/s, 50kS/s, 100kS/s, 200kS/s, 500kS/s, 1MS/s, 2MS/s, 5MS/s, 10MS/s, 20MS/s, 50MS/s, 100MS/s, 125MS/s

ATS9462

1kS/s, 2kS/s, 5kS/s, 10kS/s, 20kS/s, 50kS/s, 100kS/s, 200kS/s, 500kS/s, 1MS/s, 2MS/s, 5MS/s, 10MS/s, 20MS/s, 50MS/s, 100MS/s, 125MS/s, 160MS/s, 180MS/s

ATS9625, ATS9626, ATS9628, ATS9428

1kS/s, 2kS/s, 5kS/s, 10kS/s, 20kS/s, 50kS/s, 100kS/s, 200kS/s, 500kS/s, 1MS/s, 2MS/s, 5MS/s, 10MS/s, 20MS/s, 50MS/s, 100MS/s, 125MS/s, 250MS/s

ATS9870, AXI9870, ATS9872, ATS9874

1kS/s, 2kS/s, 5kS/s, 10kS/s, 20kS/s, 50kS/s, 100kS/s, 200kS/s, 500kS/s, 1MS/s, 2MS/s, 5MS/s, 10MS/s, 20MS/s, 50MS/s, 100MS/s, 250MS/s, 500MS/s, 1000MS/s

ATS9352, ATS9353

1kS/s, 2kS/s, 5kS/s, 10kS/s, 20kS/s, 50kS/s, 100kS/s, 200kS/s, 500kS/s, 1MS/s, 2MS/s, 5MS/s, 10MS/s, 20MS/s, 50MS/s, 100MS/s, 125MS/s, 250MS/s, 500MS/s

ATS9470

1200MS/s, 1333MS/s, 1500MS/s

ATS9473

1200MS/s, 1333MS/s, 1500MS/s, 2400MS/s, 2666MS/s, 3000MS/s

7.7 Miscellaneous features support

Bandwidth limit

ATS460, ATS660, ATS860, ATS9462

AC input coupling

ATS310, ATS330, ATS460, ATS660, ATS850, ATS860, ATS9146, ATS9350, ATS9440, ATS9462,

ATS9870, AXI9870, ATS9120, ATS9130, ATS9352, ATS9872, ATS9182, ATS9874, ATS9470,

ATS9473

DC input coupling

All boards except ATS9625, ATS9470, ATS9473

Ground input coupling

ATS9352, ATS9146, ATS9182

8-bit data packing

ATS9360, ATS9371, ATS9373, ATS9440

12-bit data packing

ATS9360, ATS9371, ATS9373

Configure LSB

ATS9440, ATS9416

7.8 External trigger level support

Board	1 V	2.5 V	5 V	TTL
ATS310	✓		✓	
ATS330	✓		✓	
ATS460	✓		✓	
ATS660	✓		✓	
ATS850	✓		✓	
ATS860	✓		✓	
ATS9350			✓	✓
ATS9351			✓	✓
ATS9360		✓		✓
ATS9371		✓		✓
ATS9373		✓		✓
ATS9416				✓
ATS9440			✓	✓
ATS9462	✓		✓	
ATS9625				✓

continues on next page

Table 2 – continued from previous page

Board	1 V	2.5 V	5 V	TTL
ATS9626				✓
ATS9870			✓	
AXI9870			✓	
ATS9120	✓			✓
ATS9130	✓			✓
ATS9352			✓	✓
ATS9353			✓	✓
ATS9146	✓			✓
ATS9872			✓	✓
ATS9628				✓
ATS9428				✓
ATS9364	✓			✓
ATS9182	✓			✓
ATS9874			✓	✓
ATS9470				✓
ATS9473				✓

7.9 Supported clock types

INTERNAL_CLOCK

ATS310, ATS330, ATS460, ATS660, ATS850, ATS860, ATS9350, ATS9351, ATS9360, ATS9371, ATS9373, ATS9416, ATS9440, ATS9462, ATS9625, ATS9626, ATS9870, AXI9870, ATS9120, ATS9130, ATS9352, ATS9353, ATS9146, ATS9872, ATS9628, ATS9428, ATS9364, ATS9182, ATS9874, ATS9470, ATS9473

FAST_EXTERNAL_CLOCK

ATS310, ATS330, ATS460, ATS850, ATS860, ATS9146, ATS9352, ATS9353, ATS9360, ATS9371, ATS9373, ATS9416, ATS9440, ATS9182

MEDIUM_EXTERNAL_CLOCK

ATS460

SLOW_EXTERNAL_CLOCK

ATS460, ATS660, ATS860, ATS9350, ATS9351, ATS9440, ATS9462, ATS9870, AXI9870, ATS9352, ATS9353, ATS9146, ATS9182

EXTERNAL_CLOCK_AC

ATS660, ATS9350, ATS9351, ATS9462, ATS9625, ATS9626, ATS9870, AXI9870, ATS9628, ATS9428, ATS9364

EXTERNAL_CLOCK_DC

ATS660, ATS9462

EXTERNAL_CLOCK_10_MHZ_REF

ATS660, ATS9350, ATS9351, ATS9360, ATS9371, ATS9373, ATS9416, ATS9440,
 ATS9462, ATS9625, ATS9626, ATS9870, AXI9870, ATS9352, ATS9353, ATS9146,
 ATS9872, ATS9628, ATS9428, ATS9364, ATS9182, ATS9874, ATS9470, ATS9473

7.10 Frequency limits for external clock types

Values are in MHz unless noted otherwise

	Fast		Medium		Slow		AC		DC	
	low	high	low	high	low	high	low	high	low	high
ATS310	0	20								
ATS330	0	50								
ATS460	80	125	10	80	0	10				
ATS660					0	10	1k	125	1k	125
ATS850										
ATS860	20	250			0	250				
ATS9350					0	20	1	500		
ATS9351					0	20	1	500		
ATS9360							300	1800		
ATS9371							300	1000		
ATS9373							300	2000		
ATS9416							5	100		
ATS9440	1	125			0	20				
ATS9462					0	10	1	180	1	180
ATS9625							50	250		
ATS9626							50	250		
ATS9870					0	60	200	1000		
AXI9870					0	60	200	1000		
ATS9120	1	20								
ATS9130	1	50								
ATS9352					0	20	1	500		
ATS9353					0	20	1	500		
ATS9146	10	125			0.001	10				
ATS9628							50	250		
ATS9428							50	250		
ATS9364							300	1000		
ATS9182	20	250			0.001	10				

7.11 Valid frequencies in PLL mode

ATS660	100-130 MHz in 1 MHz steps
ATS9350 / ATS9351	500 MHz
ATS9360	300-1800 MHz in 1 MHz steps
ATS9371	300-1000 MHz in 1 MHz steps
ATS9373 in non-DES mode	300-2000 MHz in 1 MHz steps
ATS9373 in DES mode	500-2000 MHz in 1 MHz steps
ATS9416	5-100 MHz in 1 MHz steps
ATS9440	125 MHz or 100 MHz
ATS9462	150-180 MHz in 1 MHz steps
ATS9625 / ATS9626	250 MHz
ATS9870 / AXI9870	1 GHz
ATS9352	500 MHz
ATS9353	500 MHz
ATS9364	300-1000 MHz in 1 MHz steps

Non-alphabetical

_ALAZAR_HEADER (C struct), 90
 _ALAZAR_HEADER.hdr0 (C var), 90
 _ALAZAR_HEADER.hdr1 (C var), 90
 _ALAZAR_HEADER.hdr2 (C var), 90
 _ALAZAR_HEADER.hdr3 (C var), 90
 _HEADER0 (C struct), 90
 _HEADER0.BoardNumber (C var), 90
 _HEADER0.DataFormat (C var), 91
 _HEADER0.SampleResolution (C var), 91
 _HEADER0.SerialNumber (C var), 90
 _HEADER0.SystemNumber (C var), 90
 _HEADER0.WhichChannel (C var), 90
 _HEADER1 (C struct), 91
 _HEADER1.BoardType (C var), 91
 _HEADER1.RecordNumber (C var), 91
 _HEADER2 (C struct), 91
 _HEADER2.TimeStampLowPart (C var), 91
 _HEADER3 (C struct), 91
 _HEADER3.ChannelATriggered (C var), 92
 _HEADER3.ChannelBTriggered (C var), 92
 _HEADER3.ClockEdge (C var), 91
 _HEADER3.ClockSource (C var), 91
 _HEADER3.ExternalTriggered (C var), 92
 _HEADER3.InputCoupling (C var), 92
 _HEADER3.InputImpedance (C var), 92
 _HEADER3.InputRange (C var), 92
 _HEADER3.SampleRate (C var), 92
 _HEADER3.ThisChannelTriggered (C var), 92
 _HEADER3.TimeOutOccurred (C var), 92
 _HEADER3.TimeStampHighPart (C var), 91
 _NPTFooter (C struct), 127
 _NPTFooter.aux_in_state (C var), 127
 _NPTFooter.frameCount (C var), 127
 _NPTFooter.recordNumber (C var), 127
 _NPTFooter.triggerTimestamp (C var), 127

A

ALAZAR_ADC_MODES (C enum), 157
 ALAZAR_ADC_MODES.ADC_MODE_DEFAULT (C enumerator), 157
 ALAZAR_ADC_MODES.ADC_MODE_DES (C enumerator), 157
 ALAZAR_ADMA_FLAGS (C enum), 88
 ALAZAR_ADMA_FLAGS.ADMA_ALLOC_BUFFERS (C enumerator), 88
 ALAZAR_ADMA_FLAGS.ADMA_DSP (C enumerator), 89
 ALAZAR_ADMA_FLAGS.ADMA_ENABLE_RECORD_FOOTERS (C enumerator), 89
 ALAZAR_ADMA_FLAGS.ADMA_ENABLE_RECORD_HEADERS (C enumerator), 88
 ALAZAR_ADMA_FLAGS.ADMA_EXTERNAL_STARTCAPTURE (C enumerator), 88
 ALAZAR_ADMA_FLAGS.ADMA_FIFO_ONLY_STREAMING (C enumerator), 88
 ALAZAR_ADMA_FLAGS.ADMA_GET_PROCESSED_DATA (C enumerator), 89
 ALAZAR_ADMA_FLAGS.ADMA_INTERLEAVE_SAMPLES (C enumerator), 89
 ALAZAR_ADMA_FLAGS.ADMA_PARALLEL_DMA (C enumerator), 89
 ALAZAR_ADMA_MODES (C enum), 87
 ALAZAR_ADMA_MODES.ADMA_CONTINUOUS_MODE (C enumerator), 87
 ALAZAR_ADMA_MODES.ADMA_NPT (C enumerator), 87
 ALAZAR_ADMA_MODES.ADMA_TRADITIONAL_MODE (C enumerator), 87
 ALAZAR_ADMA_MODES.ADMA_TRIGGERED_STREAMING (C enumerator), 88
 ALAZAR_API_TRACE_STATES (C enum), 154
 ALAZAR_API_TRACE_STATES.API_DISABLE_TRACE (C enumerator), 154

ALAZAR_API_TRACE_STATES.API_ENABLE_TRACE
(*C enumerator*), 155

ALAZAR_AUX_INPUT_LEVELS (*C enum*), 154

ALAZAR_AUX_INPUT_LEVELS.AUX_INPUT_HIGH (*C enumerator*), 154

ALAZAR_AUX_INPUT_LEVELS.AUX_INPUT_LOW (*C enumerator*), 154

ALAZAR_AUX_IO_MODES (*C enum*), 96

ALAZAR_AUX_IO_MODES.AUX_IN_AUXILIARY (*C enumerator*), 97

ALAZAR_AUX_IO_MODES.AUX_IN_TRIGGER_ENABLE
(*C enumerator*), 96

ALAZAR_AUX_IO_MODES.AUX_OUT_PACER (*C enumerator*), 96

ALAZAR_AUX_IO_MODES.AUX_OUT_SERIAL_DATA (*C enumerator*), 97

ALAZAR_AUX_IO_MODES.AUX_OUT_TRIGGER (*C enumerator*), 96

ALAZAR_BOARD_OPTIONS_HIGH (*C enum*), 181

ALAZAR_BOARD_OPTIONS_HIGH.OPTION_OEM_FPGA
(*C enumerator*), 181

ALAZAR_BOARD_OPTIONS_LOW (*C enum*), 179

ALAZAR_BOARD_OPTIONS_LOW.OPTION_2GHZ_ADC
(*C enumerator*), 180

ALAZAR_BOARD_OPTIONS_LOW.OPTION_180MHZ_OSCILLATOR
(*C enumerator*), 180

ALAZAR_BOARD_OPTIONS_LOW.OPTION_ALT_INPUT_RANGES
(*C enumerator*), 180

ALAZAR_BOARD_OPTIONS_LOW.OPTION_ANALOG_INPUT
(*C enumerator*), 180

ALAZAR_BOARD_OPTIONS_LOW.OPTION_DAC_OUTPUT
(*C enumerator*), 181

ALAZAR_BOARD_OPTIONS_LOW.OPTION_DCLK_PHASE
(*C enumerator*), 180

ALAZAR_BOARD_OPTIONS_LOW.OPTION_DUAL_EDGE_SAMPLING
(*C enumerator*), 180

ALAZAR_BOARD_OPTIONS_LOW.OPTION_DUAL_PORT_MEMORY
(*C enumerator*), 179

ALAZAR_BOARD_OPTIONS_LOW.OPTION_EXTERNAL_CLOCK
(*C enumerator*), 179

ALAZAR_BOARD_OPTIONS_LOW.OPTION_LOW_CROSSTALK
(*C enumerator*), 180

ALAZAR_BOARD_OPTIONS_LOW.OPTION_LVTTL_EXT_CLOCK
(*C enumerator*), 180

ALAZAR_BOARD_OPTIONS_LOW.OPTION_MULTI_FREQ_VCO
(*C enumerator*), 180

ALAZAR_BOARD_OPTIONS_LOW.OPTION_ON_FPGA_FFT
(*C enumerator*), 180

ALAZAR_BOARD_OPTIONS_LOW.OPTION_STREAMING_DMA
(*C enumerator*), 179

ALAZAR_BOARD_OPTIONS_LOW.OPTION_SW_SPI (*C enumerator*), 180

ALAZAR_BOARD_OPTIONS_LOW.OPTION_USER_CALIBRATION
(*C enumerator*), 180

ALAZAR_BOARD_OPTIONS_LOW.OPTION_VARIABLE_RATE_10MHZ_PLL
(*C enumerator*), 180

ALAZAR_BOARD_OPTIONS_LOW.OPTION_WIDEBAND
(*C enumerator*), 180

ALAZAR_CAPABILITIES (*C enum*), 177

ALAZAR_CAPABILITIES.ASOPC_TYPE (*C enumerator*), 177

ALAZAR_CAPABILITIES.BOARD_TYPE (*C enumerator*), 177

ALAZAR_CAPABILITIES.CAP_IS_VFIFO_BOARD (*C enumerator*), 178

ALAZAR_CAPABILITIES.CAP_MAX_NPT_PRETRIGGER_SAMPLES
(*C enumerator*), 178

ALAZAR_CAPABILITIES.CAP_SUPPORT_8_BIT_PACKING
(*C enumerator*), 178

ALAZAR_CAPABILITIES.CAP_SUPPORT_12_BIT_PACKING
(*C enumerator*), 179

ALAZAR_CAPABILITIES.CAP_SUPPORT_SOFTWARE_CAL
(*C enumerator*), 179

ALAZAR_CAPABILITIES.CAP_SUPPORT_TRADITIONAL_SAMPLES_INT
(*C enumerator*), 179

ALAZAR_CAPABILITIES.CAP_SUPPORTS_API_LOG_CLEAR
(*C enumerator*), 179

ALAZAR_CAPABILITIES.CAP_SUPPORTS_NATIVE_SINGLE_PORT
(*C enumerator*), 178

ALAZAR_CAPABILITIES.CAP_SUPPORTS_NPT_AUTODMA
(*C enumerator*), 178

ALAZAR_CAPABILITIES.CAP_SUPPORTS_TRADITIONAL_AUTODMA
(*C enumerator*), 178

ALAZAR_CAPABILITIES.CAP_SUPPORTS_TRIGGER_SKIPPING
(*C enumerator*), 179

ALAZAR_CAPABILITIES.GET_BOARD_OPTIONS_HIGH
(*C enumerator*), 177

ALAZAR_CAPABILITIES.GET_BOARD_OPTIONS_LOW
(*C enumerator*), 177

ALAZAR_CAPABILITIES.GET_CPF_DEVICE (*C enumerator*), 178

ALAZAR_CAPABILITIES.GET_FIRST_CAL_DATE (*C enumerator*), 177

ALAZAR_CAPABILITIES.GET_LATEST_CAL_DATE (*C enumerator*), 177

ALAZAR_CAPABILITIES.GET_LATEST_CAL_DATE_DAY

<i>(C enumerator)</i> , 177	ALAZAR_CHANNELS.CHANNEL_K <i>(C enumerator)</i> ,
ALAZAR_CAPABILITIES.GET_LATEST_CAL_DATE_MONTH <i>(C enumerator)</i> , 177	166
ALAZAR_CAPABILITIES.GET_LATEST_CAL_DATE_YEAR <i>(C enumerator)</i> , 177	ALAZAR_CHANNELS.CHANNEL_L <i>(C enumerator)</i> ,
ALAZAR_CAPABILITIES.GET_LATEST_TEST_DATE <i>(C enumerator)</i> , 177	166
ALAZAR_CAPABILITIES.GET_MAX_PRETRIGGER_SAMPLES <i>(C enumerator)</i> , 178	ALAZAR_CHANNELS.CHANNEL_M <i>(C enumerator)</i> ,
ALAZAR_CAPABILITIES.GET_PCIE_LINK_SPEED <i>(C enumerator)</i> , 178	166
ALAZAR_CAPABILITIES.GET_PCIE_LINK_WIDTH <i>(C enumerator)</i> , 178	ALAZAR_CHANNELS.CHANNEL_N <i>(C enumerator)</i> ,
ALAZAR_CAPABILITIES.GET_SERIAL_NUMBER <i>(C enumerator)</i> , 177	166
ALAZAR_CAPABILITIES.HAS_PARALLEL_DMA_SUPPORT <i>(C enumerator)</i> , 179	ALAZAR_CHANNELS.CHANNEL_O <i>(C enumerator)</i> ,
ALAZAR_CAPABILITIES.HAS_RECORD_FOOTERS_SUPPORT <i>(C enumerator)</i> , 178	166
ALAZAR_CAPABILITIES.HAS_RECORD_HEADERS_SUPPORT <i>(C enumerator)</i> , 179	ALAZAR_CHANNELS.CHANNEL_P <i>(C enumerator)</i> ,
ALAZAR_CAPABILITIES.HAS_SEQUENTIAL_DMA_SUPPORT <i>(C enumerator)</i> , 179	166
ALAZAR_CAPABILITIES.MEMORY_SIZE <i>(C enumerator)</i> , 177	ALAZAR_CLOCK_EDGES <i>(C enum)</i> , 192
ALAZAR_CHANNELS <i>(C enum)</i> , 165	ALAZAR_CLOCK_EDGES.CLOCK_EDGE_FALLING <i>(C enumerator)</i> , 192
ALAZAR_CHANNELS.CHANNEL_A <i>(C enumerator)</i> , 165	ALAZAR_CLOCK_EDGES.CLOCK_EDGE_RISING <i>(C enumerator)</i> , 192
ALAZAR_CHANNELS.CHANNEL_ALL <i>(C enumerator)</i> , 165	ALAZAR_CLOCK_SOURCES <i>(C enum)</i> , 187
ALAZAR_CHANNELS.CHANNEL_B <i>(C enumerator)</i> , 165	ALAZAR_CLOCK_SOURCES.EXTERNAL_CLOCK <i>(C enumerator)</i> , 187
ALAZAR_CHANNELS.CHANNEL_C <i>(C enumerator)</i> , 166	ALAZAR_CLOCK_SOURCES.EXTERNAL_CLOCK_10MHZ_PXI <i>(C enumerator)</i> , 188
ALAZAR_CHANNELS.CHANNEL_D <i>(C enumerator)</i> , 166	ALAZAR_CLOCK_SOURCES.EXTERNAL_CLOCK_10MHZ_REF <i>(C enumerator)</i> , 188
ALAZAR_CHANNELS.CHANNEL_E <i>(C enumerator)</i> , 166	ALAZAR_CLOCK_SOURCES.EXTERNAL_CLOCK_AC <i>(C enumerator)</i> , 188
ALAZAR_CHANNELS.CHANNEL_F <i>(C enumerator)</i> , 166	ALAZAR_CLOCK_SOURCES.EXTERNAL_CLOCK_DC <i>(C enumerator)</i> , 188
ALAZAR_CHANNELS.CHANNEL_G <i>(C enumerator)</i> , 166	ALAZAR_CLOCK_SOURCES.FAST_EXTERNAL_CLOCK <i>(C enumerator)</i> , 187
ALAZAR_CHANNELS.CHANNEL_H <i>(C enumerator)</i> , 166	ALAZAR_CLOCK_SOURCES.INTERNAL_CLOCK <i>(C enumerator)</i> , 187
ALAZAR_CHANNELS.CHANNEL_I <i>(C enumerator)</i> , 166	ALAZAR_CLOCK_SOURCES.INTERNAL_CLOCK_10MHZ_REF <i>(C enumerator)</i> , 188
ALAZAR_CHANNELS.CHANNEL_J <i>(C enumerator)</i> , 166	ALAZAR_CLOCK_SOURCES.MEDIUM_EXTERNAL_CLOCK <i>(C enumerator)</i> , 187
	ALAZAR_CLOCK_SOURCES.SLOW_EXTERNAL_CLOCK <i>(C enumerator)</i> , 188
	ALAZAR_COPROCESSOR_DOWNLOAD_OPTIONS <i>(C enum)</i> , 104
	ALAZAR_COPROCESSOR_DOWNLOAD_OPTIONS.CPF_OPTION_DMA_DOWNLOAD <i>(C enumerator)</i> , 104
	ALAZAR_COUPLINGS <i>(C enum)</i> , 172
	ALAZAR_COUPLINGS.AC_COUPLING <i>(C enumerator)</i> , 172
	ALAZAR_COUPLINGS.DC_COUPLING <i>(C enumerator)</i> , 172
	ALAZAR_COUPLINGS.GND_COUPLING <i>(C enumerator)</i> , 172

- tor*), [172](#)
- ALAZAR_CRA_MODES (C enum), [100](#)
- ALAZAR_CRA_MODES.CRA_MODE_DISABLE (C enumerator), [100](#)
- ALAZAR_CRA_MODES.CRA_MODE_ENABLE_FPGA_AVE (C enumerator), [100](#)
- ALAZAR_CRA_OPTIONS (C enum), [100](#)
- ALAZAR_CRA_OPTIONS.CRA_OPTION_SIGNED (C enumerator), [100](#)
- ALAZAR_CRA_OPTIONS.CRA_OPTION_UNSIGNED (C enumerator), [100](#)
- ALAZAR_ECC_MODES (C enum), [154](#)
- ALAZAR_ECC_MODES.ECC_DISABLE (C enumerator), [154](#)
- ALAZAR_ECC_MODES.ECC_ENABLE (C enumerator), [154](#)
- ALAZAR_EXTERNAL_TRIGGER_RANGES (C enum), [193](#)
- ALAZAR_EXTERNAL_TRIGGER_RANGES.ETR_1V_500HM (C enumerator), [193](#)
- ALAZAR_EXTERNAL_TRIGGER_RANGES.ETR_2V5_500HM (C enumerator), [194](#)
- ALAZAR_EXTERNAL_TRIGGER_RANGES.ETR_5V_500HM (C enumerator), [193](#)
- ALAZAR_EXTERNAL_TRIGGER_RANGES.ETR_5V_3000HM (C enumerator), [194](#)
- ALAZAR_EXTERNAL_TRIGGER_RANGES.ETR_TTL (C enumerator), [193](#)
- ALAZAR_IMPEDANCES (C enum), [172](#)
- ALAZAR_IMPEDANCES.IMPEDANCE_1M_OHM (C enumerator), [172](#)
- ALAZAR_IMPEDANCES.IMPEDANCE_50_OHM (C enumerator), [172](#)
- ALAZAR_IMPEDANCES.IMPEDANCE_75_OHM (C enumerator), [172](#)
- ALAZAR_IMPEDANCES.IMPEDANCE_100_OHM (C enumerator), [172](#)
- ALAZAR_IMPEDANCES.IMPEDANCE_300_OHM (C enumerator), [172](#)
- ALAZAR_INPUT_RANGES (C enum), [167](#)
- ALAZAR_INPUT_RANGES.INPUT_RANGE_0_TO_1_V (C enumerator), [169](#)
- ALAZAR_INPUT_RANGES.INPUT_RANGE_0_TO_2_V (C enumerator), [169](#)
- ALAZAR_INPUT_RANGES.INPUT_RANGE_0_TO_2_V_5 (C enumerator), [169](#)
- ALAZAR_INPUT_RANGES.INPUT_RANGE_0_TO_4_V (C enumerator), [169](#)
- ALAZAR_INPUT_RANGES.INPUT_RANGE_0_TO_5_V (C enumerator), [169](#)
- ALAZAR_INPUT_RANGES.INPUT_RANGE_0_TO_8_V (C enumerator), [169](#)
- ALAZAR_INPUT_RANGES.INPUT_RANGE_0_TO_10_V (C enumerator), [169](#)
- ALAZAR_INPUT_RANGES.INPUT_RANGE_0_TO_16_V (C enumerator), [170](#)
- ALAZAR_INPUT_RANGES.INPUT_RANGE_0_TO_20_V (C enumerator), [170](#)
- ALAZAR_INPUT_RANGES.INPUT_RANGE_0_TO_32_V (C enumerator), [170](#)
- ALAZAR_INPUT_RANGES.INPUT_RANGE_0_TO_40_MV (C enumerator), [168](#)
- ALAZAR_INPUT_RANGES.INPUT_RANGE_0_TO_80_MV (C enumerator), [168](#)
- ALAZAR_INPUT_RANGES.INPUT_RANGE_0_TO_80_V (C enumerator), [170](#)
- ALAZAR_INPUT_RANGES.INPUT_RANGE_0_TO_100_MV (C enumerator), [168](#)
- ALAZAR_INPUT_RANGES.INPUT_RANGE_0_TO_160_MV (C enumerator), [169](#)
- ALAZAR_INPUT_RANGES.INPUT_RANGE_0_TO_200_MV (C enumerator), [169](#)
- ALAZAR_INPUT_RANGES.INPUT_RANGE_0_TO_250_MV (C enumerator), [169](#)
- ALAZAR_INPUT_RANGES.INPUT_RANGE_0_TO_400_MV (C enumerator), [169](#)
- ALAZAR_INPUT_RANGES.INPUT_RANGE_0_TO_500_MV (C enumerator), [169](#)
- ALAZAR_INPUT_RANGES.INPUT_RANGE_0_TO_800_MV (C enumerator), [169](#)
- ALAZAR_INPUT_RANGES.INPUT_RANGE_0_TO_1600_MV (C enumerator), [169](#)
- ALAZAR_INPUT_RANGES.INPUT_RANGE_0_TO_MINUS_1_V (C enumerator), [170](#)
- ALAZAR_INPUT_RANGES.INPUT_RANGE_0_TO_MINUS_2_V (C enumerator), [171](#)
- ALAZAR_INPUT_RANGES.INPUT_RANGE_0_TO_MINUS_2_V_5 (C enumerator), [171](#)
- ALAZAR_INPUT_RANGES.INPUT_RANGE_0_TO_MINUS_4_V (C enumerator), [171](#)
- ALAZAR_INPUT_RANGES.INPUT_RANGE_0_TO_MINUS_5_V (C enumerator), [171](#)
- ALAZAR_INPUT_RANGES.INPUT_RANGE_0_TO_MINUS_8_V (C enumerator), [171](#)
- ALAZAR_INPUT_RANGES.INPUT_RANGE_0_TO_MINUS_10_V (C enumerator), [171](#)

ALAZAR_INPUT_RANGES.INPUT_RANGE_0_TO_MINUS_160_MV (C enumerator), 171

ALAZAR_INPUT_RANGES.INPUT_RANGE_0_TO_MINUS_200_MV (C enumerator), 171

ALAZAR_INPUT_RANGES.INPUT_RANGE_0_TO_MINUS_320_MV (C enumerator), 171

ALAZAR_INPUT_RANGES.INPUT_RANGE_0_TO_MINUS_400_MV (C enumerator), 170

ALAZAR_INPUT_RANGES.INPUT_RANGE_0_TO_MINUS_800_MV (C enumerator), 170

ALAZAR_INPUT_RANGES.INPUT_RANGE_0_TO_MINUS_800_MV (C enumerator), 171

ALAZAR_INPUT_RANGES.INPUT_RANGE_0_TO_MINUS_1000_MV (C enumerator), 170

ALAZAR_INPUT_RANGES.INPUT_RANGE_0_TO_MINUS_1600_MV (C enumerator), 170

ALAZAR_INPUT_RANGES.INPUT_RANGE_0_TO_MINUS_2000_MV (C enumerator), 170

ALAZAR_INPUT_RANGES.INPUT_RANGE_0_TO_MINUS_2500_MV (C enumerator), 170

ALAZAR_INPUT_RANGES.INPUT_RANGE_0_TO_MINUS_4000_MV (C enumerator), 170

ALAZAR_INPUT_RANGES.INPUT_RANGE_0_TO_MINUS_5000_MV (C enumerator), 170

ALAZAR_INPUT_RANGES.INPUT_RANGE_0_TO_MINUS_8000_MV (C enumerator), 170

ALAZAR_INPUT_RANGES.INPUT_RANGE_0_TO_MINUS_16000_MV (C enumerator), 171

ALAZAR_INPUT_RANGES.INPUT_RANGE_PM_1_V (C enumerator), 167

ALAZAR_INPUT_RANGES.INPUT_RANGE_PM_1_V_25 (C enumerator), 168

ALAZAR_INPUT_RANGES.INPUT_RANGE_PM_2_V (C enumerator), 167

ALAZAR_INPUT_RANGES.INPUT_RANGE_PM_2_V_5 (C enumerator), 168

ALAZAR_INPUT_RANGES.INPUT_RANGE_PM_4_V (C enumerator), 167

ALAZAR_INPUT_RANGES.INPUT_RANGE_PM_5_V (C enumerator), 168

ALAZAR_INPUT_RANGES.INPUT_RANGE_PM_8_V (C enumerator), 168

ALAZAR_INPUT_RANGES.INPUT_RANGE_PM_10_V (C enumerator), 168

ALAZAR_INPUT_RANGES.INPUT_RANGE_PM_16_V (C enumerator), 168

ALAZAR_INPUT_RANGES.INPUT_RANGE_PM_20_MV (C enumerator), 167

ALAZAR_INPUT_RANGES.INPUT_RANGE_PM_20_V (C enumerator), 168

ALAZAR_INPUT_RANGES.INPUT_RANGE_PM_40_MV (C enumerator), 167

ALAZAR_INPUT_RANGES.INPUT_RANGE_PM_40_V (C enumerator), 168

ALAZAR_INPUT_RANGES.INPUT_RANGE_PM_50_MV (C enumerator), 167

ALAZAR_INPUT_RANGES.INPUT_RANGE_PM_80_MV (C enumerator), 167

ALAZAR_INPUT_RANGES.INPUT_RANGE_PM_100_MV (C enumerator), 167

ALAZAR_INPUT_RANGES.INPUT_RANGE_PM_125_MV (C enumerator), 168

ALAZAR_INPUT_RANGES.INPUT_RANGE_PM_200_MV (C enumerator), 167

ALAZAR_INPUT_RANGES.INPUT_RANGE_PM_250_MV (C enumerator), 168

ALAZAR_INPUT_RANGES.INPUT_RANGE_PM_400_MV (C enumerator), 167

ALAZAR_INPUT_RANGES.INPUT_RANGE_PM_500_MV (C enumerator), 167

ALAZAR_INPUT_RANGES.INPUT_RANGE_PM_560_MV (C enumerator), 171

ALAZAR_INPUT_RANGES.INPUT_RANGE_PM_800_MV (C enumerator), 167

ALAZAR_INPUT_RANGES.INPUT_RANGE_UNCALIBRATED (C enumerator), 168

ALAZAR_INPUT_RANGES.INPUT_RANGE_UNCALIBRATED_PM_750_MV (C enumerator), 171

ALAZAR_LED (C enum), 194

ALAZAR_LED.LED_OFF (C enumerator), 194

ALAZAR_LED.LED_ON (C enumerator), 194

ALAZAR_LSB (C enum), 98

ALAZAR_LSB.LSB_AUX_IN_1 (C enumerator), 98

ALAZAR_LSB.LSB_AUX_IN_2 (C enumerator), 98

ALAZAR_LSB.LSB_DEFAULT (C enumerator), 98

ALAZAR_LSB.LSB_EXT_TRIG (C enumerator), 98

ALAZAR_PACK_MODES (C enum), 154

ALAZAR_PACK_MODES.PACK_8_BITS_PER_SAMPLE (C enumerator), 154

ALAZAR_PACK_MODES.PACK_12_BITS_PER_SAMPLE (C enumerator), 154

ALAZAR_PACK_MODES.PACK_DEFAULT (C enumerator), 154

ALAZAR_PARAMETERS (C enum), 151

ALAZAR_PARAMETERS_UL (C enum), 156

ALAZAR_PARAMETERS_UL.GET_POWER_MONITOR_STATUS

(*C enumerator*), [156](#)

ALAZAR_PARAMETERS_UL.SET_ADC_MODE (*C enumerator*), [156](#)

ALAZAR_PARAMETERS_UL.SET_BUFFERS_PER_TRIGGER_ENABLE (*C enumerator*), [156](#)

ALAZAR_PARAMETERS_UL.SET_EXT_TRIGGER_RANGE (*C enumerator*), [157](#)

ALAZAR_PARAMETERS.API_FLAGS (*C enumerator*), [153](#)

ALAZAR_PARAMETERS.API_LOG_CLEAR (*C enumerator*), [153](#)

ALAZAR_PARAMETERS.DATA_WIDTH (*C enumerator*), [151](#)

ALAZAR_PARAMETERS.ECC_MODE (*C enumerator*), [152](#)

ALAZAR_PARAMETERS.GET_ADC_TEMPERATURE (*C enumerator*), [153](#)

ALAZAR_PARAMETERS.GET_ASYNC_BUFFERS_PENDING (*C enumerator*), [152](#)

ALAZAR_PARAMETERS.GET_ASYNC_BUFFERS_PENDING_EMITTER (*C enumerator*), [152](#)

ALAZAR_PARAMETERS.GET_ASYNC_BUFFERS_PENDING_FILTER (*C enumerator*), [152](#)

ALAZAR_PARAMETERS.GET_AUX_INPUT_LEVEL (*C enumerator*), [152](#)

ALAZAR_PARAMETERS.GET_CHANNELS_PER_BOARD (*C enumerator*), [152](#)

ALAZAR_PARAMETERS.GET_DATA_FORMAT (*C enumerator*), [152](#)

ALAZAR_PARAMETERS.GET_FPGA_TEMPERATURE (*C enumerator*), [152](#)

ALAZAR_PARAMETERS.GET_ONBOARD_MEMORY_USED (*C enumerator*), [153](#)

ALAZAR_PARAMETERS.GET_RECORDS_CAPTURED (*C enumerator*), [152](#)

ALAZAR_PARAMETERS.GET_SAMPLES_PER_TIMESTAMP_CLOCK (*C enumerator*), [152](#)

ALAZAR_PARAMETERS.PACK_MODE (*C enumerator*), [153](#)

ALAZAR_PARAMETERS.SET_DATA_FORMAT (*C enumerator*), [152](#)

ALAZAR_PARAMETERS.SET_SINGLE_CHANNEL_MODE (*C enumerator*), [153](#)

ALAZAR_PARAMETERS.SET_SOFTWARE_CAL_MECHANISM (*C enumerator*), [153](#)

ALAZAR_PARAMETERS.SETGET_ASYNC_BUFFCOUNT (*C enumerator*), [151](#)

ALAZAR_PARAMETERS.SETGET_ASYNC_BUFFSIZE_BYTES (*C enumerator*), [151](#)

(*C enumerator*), [151](#)

ALAZAR_PARAMETERS.SETGET_TRIGGER_SKIPPING (*C enumerator*), [153](#)

ALAZAR_POWER_STATES (C enum), [205](#)

ALAZAR_POWER_STATES.POWER_OFF (*C enumerator*), [205](#)

ALAZAR_POWER_STATES.POWER_ON (*C enumerator*), [205](#)

ALAZAR_SAMPLE_RATES (C enum), [188](#)

ALAZAR_SAMPLE_RATES.SAMPLE_RATE_1GSPS (*C enumerator*), [190](#)

ALAZAR_SAMPLE_RATES.SAMPLE_RATE_1KSPS (*C enumerator*), [188](#)

ALAZAR_SAMPLE_RATES.SAMPLE_RATE_1MSPS (*C enumerator*), [189](#)

ALAZAR_SAMPLE_RATES.SAMPLE_RATE_2GSPS (*C enumerator*), [190](#)

ALAZAR_SAMPLE_RATES.SAMPLE_RATE_2KSPS (*C enumerator*), [188](#)

ALAZAR_SAMPLE_RATES.SAMPLE_RATE_2MSPS (*C enumerator*), [189](#)

ALAZAR_SAMPLE_RATES.SAMPLE_RATE_3GSPS (*C enumerator*), [191](#)

ALAZAR_SAMPLE_RATES.SAMPLE_RATE_4GSPS (*C enumerator*), [191](#)

ALAZAR_SAMPLE_RATES.SAMPLE_RATE_5GSPS (*C enumerator*), [191](#)

ALAZAR_SAMPLE_RATES.SAMPLE_RATE_5KSPS (*C enumerator*), [188](#)

ALAZAR_SAMPLE_RATES.SAMPLE_RATE_5MSPS (*C enumerator*), [189](#)

ALAZAR_SAMPLE_RATES.SAMPLE_RATE_10GSPS (*C enumerator*), [191](#)

ALAZAR_SAMPLE_RATES.SAMPLE_RATE_10KSPS (*C enumerator*), [188](#)

ALAZAR_SAMPLE_RATES.SAMPLE_RATE_10MSPS (*C enumerator*), [189](#)

ALAZAR_SAMPLE_RATES.SAMPLE_RATE_20KSPS (*C enumerator*), [188](#)

ALAZAR_SAMPLE_RATES.SAMPLE_RATE_20MSPS (*C enumerator*), [189](#)

ALAZAR_SAMPLE_RATES.SAMPLE_RATE_25MSPS (*C enumerator*), [189](#)

ALAZAR_SAMPLE_RATES.SAMPLE_RATE_50KSPS (*C enumerator*), [188](#)

ALAZAR_SAMPLE_RATES.SAMPLE_RATE_50MSPS (*C enumerator*), [189](#)

ALAZAR_SAMPLE_RATES.SAMPLE_RATE_100KSPS (*C*

- [enumerator\), 189](#)
- ALAZAR_SAMPLE_RATES.SAMPLE_RATE_100MSPS ([C enumerator\), 189](#)
- ALAZAR_SAMPLE_RATES.SAMPLE_RATE_125MSPS ([C enumerator\), 189](#)
- ALAZAR_SAMPLE_RATES.SAMPLE_RATE_160MSPS ([C enumerator\), 189](#)
- ALAZAR_SAMPLE_RATES.SAMPLE_RATE_180MSPS ([C enumerator\), 189](#)
- ALAZAR_SAMPLE_RATES.SAMPLE_RATE_200KSPS ([C enumerator\), 189](#)
- ALAZAR_SAMPLE_RATES.SAMPLE_RATE_200MSPS ([C enumerator\), 190](#)
- ALAZAR_SAMPLE_RATES.SAMPLE_RATE_250MSPS ([C enumerator\), 190](#)
- ALAZAR_SAMPLE_RATES.SAMPLE_RATE_300MSPS ([C enumerator\), 191](#)
- ALAZAR_SAMPLE_RATES.SAMPLE_RATE_350MSPS ([C enumerator\), 191](#)
- ALAZAR_SAMPLE_RATES.SAMPLE_RATE_370MSPS ([C enumerator\), 191](#)
- ALAZAR_SAMPLE_RATES.SAMPLE_RATE_400MSPS ([C enumerator\), 190](#)
- ALAZAR_SAMPLE_RATES.SAMPLE_RATE_500KSPS ([C enumerator\), 189](#)
- ALAZAR_SAMPLE_RATES.SAMPLE_RATE_500MSPS ([C enumerator\), 190](#)
- ALAZAR_SAMPLE_RATES.SAMPLE_RATE_800MSPS ([C enumerator\), 190](#)
- ALAZAR_SAMPLE_RATES.SAMPLE_RATE_1000MSPS ([C enumerator\), 190](#)
- ALAZAR_SAMPLE_RATES.SAMPLE_RATE_1200MSPS ([C enumerator\), 190](#)
- ALAZAR_SAMPLE_RATES.SAMPLE_RATE_1333MSPS_RECORDER ([C enumerator\), 191](#)
- ALAZAR_SAMPLE_RATES.SAMPLE_RATE_1500MSPS ([C enumerator\), 190](#)
- ALAZAR_SAMPLE_RATES.SAMPLE_RATE_1600MSPS ([C enumerator\), 190](#)
- ALAZAR_SAMPLE_RATES.SAMPLE_RATE_1800MSPS ([C enumerator\), 190](#)
- ALAZAR_SAMPLE_RATES.SAMPLE_RATE_2000MSPS ([C enumerator\), 190](#)
- ALAZAR_SAMPLE_RATES.SAMPLE_RATE_2400MSPS ([C enumerator\), 190](#)
- ALAZAR_SAMPLE_RATES.SAMPLE_RATE_2666MSPS_RECORDER ([C enumerator\), 191](#)
- ALAZAR_SAMPLE_RATES.SAMPLE_RATE_3000MSPS ([C enumerator\), 191](#)
- ALAZAR_SAMPLE_RATES.SAMPLE_RATE_3600MSPS ([C enumerator\), 191](#)
- ALAZAR_SAMPLE_RATES.SAMPLE_RATE_4000MSPS ([C enumerator\), 191](#)
- ALAZAR_SAMPLE_RATES.SAMPLE_RATE_5000MSPS ([C enumerator\), 191](#)
- ALAZAR_SAMPLE_RATES.SAMPLE_RATE_10000MSPS ([C enumerator\), 191](#)
- ALAZAR_SAMPLE_RATES.SAMPLE_RATE_USER_DEF ([C enumerator\), 192](#)
- ALAZAR_SAMPLE_SKIPPING_MODES ([C enum\), 102](#)
- ALAZAR_SAMPLE_SKIPPING_MODES.SSM_DISABLE ([C enumerator\), 102](#)
- ALAZAR_SAMPLE_SKIPPING_MODES.SSM_ENABLE ([C enumerator\), 102](#)
- ALAZAR_STOS_OPTIONS ([C enum\), 204](#)
- ALAZAR_STOS_OPTIONS.STOS_OPTION_DEFER_START_CAPTURE ([C enumerator\), 204](#)
- ALAZAR_TIMESTAMP_RESET_OPTIONS ([C enum\), 184](#)
- ALAZAR_TIMESTAMP_RESET_OPTIONS.TIMESTAMP_RESET_ALWAYS ([C enumerator\), 184](#)
- ALAZAR_TIMESTAMP_RESET_OPTIONS.TIMESTAMP_RESET_FIRSTTIME ([C enumerator\), 184](#)
- ALAZAR_TRIGGER_ENGINES ([C enum\), 201](#)
- ALAZAR_TRIGGER_ENGINES.TRIG_ENGINE_J ([C enumerator\), 201](#)
- ALAZAR_TRIGGER_ENGINES.TRIG_ENGINE_K ([C enumerator\), 201](#)
- ALAZAR_TRIGGER_OPERATIONS ([C enum\), 200](#)
- ALAZAR_TRIGGER_OPERATIONS.TRIG_ENGINE_OP_J ([C enumerator\), 200](#)
- ALAZAR_TRIGGER_OPERATIONS.TRIG_ENGINE_OP_J_AND_K ([C enumerator\), 201](#)
- ALAZAR_TRIGGER_OPERATIONS.TRIG_ENGINE_OP_J_AND_NOT_K ([C enumerator\), 201](#)
- ALAZAR_TRIGGER_OPERATIONS.TRIG_ENGINE_OP_J_OR_K ([C enumerator\), 201](#)
- ALAZAR_TRIGGER_OPERATIONS.TRIG_ENGINE_OP_J_XOR_K ([C enumerator\), 201](#)
- ALAZAR_TRIGGER_OPERATIONS.TRIG_ENGINE_OP_K ([C enumerator\), 200](#)
- ALAZAR_TRIGGER_OPERATIONS.TRIG_ENGINE_OP_NOT_J_AND_K ([C enumerator\), 201](#)
- ALAZAR_TRIGGER_SLOPES ([C enum\), 203](#)
- ALAZAR_TRIGGER_SLOPES.TRIGGER_SLOPE_NEGATIVE ([C enumerator\), 203](#)

ALAZAR_TRIGGER_SLOPES.TRIGGER_SLOPE_POSITIVEAlazarBoardsInSystemByHandle (C function), (C enumerator), 203 93

ALAZAR_TRIGGER_SOURCES (C enum), 201 AlazarBoardsInSystemBySystemID (C function), 94

ALAZAR_TRIGGER_SOURCES.TRIG_CHAN_A (C enumerator), 201 AlazarBusy (C function), 94

ALAZAR_TRIGGER_SOURCES.TRIG_CHAN_B (C enumerator), 201 AlazarConfigureAuxIO (C function), 95

ALAZAR_TRIGGER_SOURCES.TRIG_CHAN_C (C enumerator), 202 AlazarConfigureLSB (C function), 97

ALAZAR_TRIGGER_SOURCES.TRIG_CHAN_D (C enumerator), 202 AlazarConfigureRecordAverage (C function), 98

ALAZAR_TRIGGER_SOURCES.TRIG_CHAN_E (C enumerator), 202 AlazarConfigureSampleSkipping (C function), 100

ALAZAR_TRIGGER_SOURCES.TRIG_CHAN_F (C enumerator), 202 AlazarCoproprocessorDownloadA (C function), 103

ALAZAR_TRIGGER_SOURCES.TRIG_CHAN_G (C enumerator), 202 AlazarCoproprocessorDownloadW (C function), 103

ALAZAR_TRIGGER_SOURCES.TRIG_CHAN_H (C enumerator), 202 AlazarCoproprocessorRegisterRead (C function), 104

ALAZAR_TRIGGER_SOURCES.TRIG_CHAN_I (C enumerator), 202 AlazarCoproprocessorRegisterWrite (C function), 104

ALAZAR_TRIGGER_SOURCES.TRIG_CHAN_J (C enumerator), 202 AlazarCreateStreamFileA (C function), 105

ALAZAR_TRIGGER_SOURCES.TRIG_CHAN_K (C enumerator), 202 AlazarCreateStreamFileW (C function), 106

ALAZAR_TRIGGER_SOURCES.TRIG_CHAN_L (C enumerator), 202 AlazarDSPAbortCapture (C function), 107

ALAZAR_TRIGGER_SOURCES.TRIG_CHAN_M (C enumerator), 202 AlazarDSPGenerateWindowFunction (C function), 107

ALAZAR_TRIGGER_SOURCES.TRIG_CHAN_N (C enumerator), 202 AlazarDSPGetBuffer (C function), 109

ALAZAR_TRIGGER_SOURCES.TRIG_CHAN_O (C enumerator), 202 AlazarDSPGetInfo (C function), 110

ALAZAR_TRIGGER_SOURCES.TRIG_CHAN_P (C enumerator), 203 AlazarDSPGetModules (C function), 111

ALAZAR_TRIGGER_SOURCES.TRIG_DISABLE (C enumerator), 202 AlazarDSPGetNextBuffer (C function), 112

ALAZAR_TRIGGER_SOURCES.TRIG_EXTERNAL (C enumerator), 201 AlazarDSPGetParameterFloat (C function), 113

AlazarAbortAsyncRead (C function), 81 AlazarDSPGetParameterS32 (C function), 114

AlazarAbortCapture (C function), 81 AlazarDSPGetParameterU32 (C function), 115

AlazarAllocBufferU8 (C function), 83 AlazarDSPSetParameterFloat (C function), 116

AlazarAllocBufferU8Ex (C function), 83 AlazarDSPSetParameterS32 (C function), 116

AlazarAllocBufferU16 (C function), 82 AlazarDSPSetParameterU32 (C function), 117

AlazarAllocBufferU16Ex (C function), 82 AlazarErrorToText (C function), 117

AlazarAsyncRead (C function), 84 AlazarExtractFFTNPFTFooters (C function), 125

AlazarBeforeAsyncRead (C function), 85 AlazarExtractNPFTFooters (C function), 126

AlazarBoardsFound (C function), 93 AlazarExtractTimeDomainNPFTFooters (C function), 128

AlazarFFTBackgroundSubtractionGetRecordS16 (C function), 129

AlazarFFTBackgroundSubtractionSetEnabled (C function), 129

AlazarFFTBackgroundSubtractionSetRecordS16 (C function), 130

AlazarFFTGetMaxTriggerRepeatRate (C function), 130

AlazarFFTSetGainAndOffset (C function), 131

AlazarFFTSetScalingAndSlicing (C function), 132

- AlazarFFTSetup (C function), 135
- AlazarFFTSetWindowFunction (C function), 134
- AlazarForceTrigger (C function), 137
- AlazarForceTriggerEnable (C function), 138
- AlazarFreeBufferU8 (C function), 139
- AlazarFreeBufferU8Ex (C function), 139
- AlazarFreeBufferU16 (C function), 138
- AlazarFreeBufferU16Ex (C function), 139
- AlazarGetBoardBySystemHandle (C function), 140
- AlazarGetBoardBySystemID (C function), 140
- AlazarGetBoardKind (C function), 141
- AlazarGetBoardRevision (C function), 146
- AlazarGetChannelInfo (C function), 147
- AlazarGetChannelInfoEx (C function), 148
- AlazarGetCPLDVersion (C function), 146
- AlazarGetDriverVersion (C function), 148
- AlazarGetFPGAVersion (C function), 149
- AlazarGetMaxRecordsCapable (C function), 150
- AlazarGetParameter (C function), 151
- AlazarGetParameterLL (C function), 155
- AlazarGetParameterUL (C function), 155
- AlazarGetSDKVersion (C function), 157
- AlazarGetStatus (C function), 158
- AlazarGetSystemHandle (C function), 159
- AlazarGetTriggerAddress (C function), 159
- AlazarGetTriggerTimestamp (C function), 161
- AlazarGetWhoTriggeredBySystemHandle (C function), 161
- AlazarGetWhoTriggeredBySystemID (C function), 162
- AlazarHyperDisp (C function), 163
- AlazarInputControl (C function), 164
- AlazarInputControlEx (C function), 172
- AlazarNumOfSystems (C function), 173
- AlazarOCTIgnoreBadClock (C function), 173
- AlazarPostAsyncBuffer (C function), 175
- AlazarQueryCapability (C function), 176
- AlazarQueryCapabilityLL (C function), 181
- AlazarRead (C function), 181
- AlazarReadEx (C function), 183
- AlazarResetTimeStamp (C function), 184
- AlazarSetADCBBackgroundCompensation (C function), 185
- AlazarSetBWLlimit (C function), 185
- AlazarSetCaptureClock (C function), 186
- AlazarSetExternalClockLevel (C function), 192
- AlazarSetExternalTrigger (C function), 193
- AlazarSetLED (C function), 194
- AlazarSetParameter (C function), 195
- AlazarSetParameterLL (C function), 195
- AlazarSetParameterUL (C function), 196
- AlazarSetRecordCount (C function), 196
- AlazarSetRecordSize (C function), 197
- AlazarSetTriggerDelay (C function), 198
- AlazarSetTriggerOperation (C function), 199
- AlazarSetTriggerOperationForScanning (C function), 203
- AlazarSetTriggerTimeOut (C function), 204
- AlazarSleepDevice (C function), 205
- AlazarStartCapture (C function), 206
- AlazarTriggered (C function), 206
- AlazarWaitAsyncBufferComplete (C function), 207
- AlazarWaitNextAsyncBufferComplete (C function), 208
- ## B
- BoardTypes (C enum), 141
- BoardTypes.ATG6500 (C enumerator), 143
- BoardTypes.ATS310 (C enumerator), 142
- BoardTypes.ATS315 (C enumerator), 142
- BoardTypes.ATS330 (C enumerator), 142
- BoardTypes.ATS335 (C enumerator), 142
- BoardTypes.ATS460 (C enumerator), 142
- BoardTypes.ATS660 (C enumerator), 142
- BoardTypes.ATS665 (C enumerator), 142
- BoardTypes.ATS850 (C enumerator), 142
- BoardTypes.ATS855 (C enumerator), 142
- BoardTypes.ATS860 (C enumerator), 142
- BoardTypes.ATS4001 (C enumerator), 145
- BoardTypes.ATS9000 (C enumerator), 144
- BoardTypes.ATS9120 (C enumerator), 144
- BoardTypes.ATS9130 (C enumerator), 144
- BoardTypes.ATS9146 (C enumerator), 144
- BoardTypes.ATS9182 (C enumerator), 145
- BoardTypes.ATS9280 (C enumerator), 145
- BoardTypes.ATS9310 (C enumerator), 143
- BoardTypes.ATS9325 (C enumerator), 143
- BoardTypes.ATS9350 (C enumerator), 142
- BoardTypes.ATS9351 (C enumerator), 143
- BoardTypes.ATS9352 (C enumerator), 144
- BoardTypes.ATS9353 (C enumerator), 145
- BoardTypes.ATS9358 (C enumerator), 144
- BoardTypes.ATS9360 (C enumerator), 143

BoardTypes.ATS9364 (*C enumerator*), [145](#)
 BoardTypes.ATS9370 (*C enumerator*), [143](#)
 BoardTypes.ATS9371 (*C enumerator*), [144](#)
 BoardTypes.ATS9373 (*C enumerator*), [144](#)
 BoardTypes.ATS9376 (*C enumerator*), [145](#)
 BoardTypes.ATS9380 (*C enumerator*), [145](#)
 BoardTypes.ATS9410 (*C enumerator*), [143](#)
 BoardTypes.ATS9416 (*C enumerator*), [144](#)
 BoardTypes.ATS9428 (*C enumerator*), [145](#)
 BoardTypes.ATS9434 (*C enumerator*), [142](#)
 BoardTypes.ATS9437 (*C enumerator*), [144](#)
 BoardTypes.ATS9440 (*C enumerator*), [143](#)
 BoardTypes.ATS9442 (*C enumerator*), [145](#)
 BoardTypes.ATS9453 (*C enumerator*), [144](#)
 BoardTypes.ATS9461 (*C enumerator*), [143](#)
 BoardTypes.ATS9462 (*C enumerator*), [142](#)
 BoardTypes.ATS9470 (*C enumerator*), [145](#)
 BoardTypes.ATS9473 (*C enumerator*), [145](#)
 BoardTypes.ATS9618 (*C enumerator*), [144](#)
 BoardTypes.ATS9625 (*C enumerator*), [143](#)
 BoardTypes.ATS9626 (*C enumerator*), [143](#)
 BoardTypes.ATS9628 (*C enumerator*), [145](#)
 BoardTypes.ATS9637 (*C enumerator*), [144](#)
 BoardTypes.ATS9850 (*C enumerator*), [143](#)
 BoardTypes.ATS9870 (*C enumerator*), [142](#)
 BoardTypes.ATS9872 (*C enumerator*), [145](#)
 BoardTypes.ATS9874 (*C enumerator*), [145](#)
 BoardTypes.ATS_NONE (*C enumerator*), [141](#)
 BoardTypes.ATST371 (*C enumerator*), [144](#)
 BoardTypes.ATU7825 (*C enumerator*), [143](#)
 BoardTypes.AXI9870 (*C enumerator*), [143](#)

D

DSP_MODULE_TYPE (*C enum*), [111](#)
 DSP_MODULE_TYPE.DSP_MODULE_DIS (*C enumerator*), [111](#)
 DSP_MODULE_TYPE.DSP_MODULE_FFT (*C enumerator*), [111](#)
 DSP_MODULE_TYPE.DSP_MODULE_NONE (*C enumerator*), [111](#)
 DSP_MODULE_TYPE.DSP_MODULE_PCD (*C enumerator*), [111](#)
 DSP_MODULE_TYPE.DSP_MODULE_SSK (*C enumerator*), [111](#)
 DSP_PARAMETERS_FLOAT (*C enum*), [114](#)
 DSP_PARAMETERS_S32 (*C enum*), [114](#)
 DSP_PARAMETERS_U32 (*C enum*), [115](#)

DSP_PARAMETERS_U32.DSP_FFT_GAIN_OFFSET_SUPPORTED (*C enumerator*), [115](#)
 DSP_PARAMETERS_U32.DSP_FFT_SUBTRACTOR_SUPPORTED (*C enumerator*), [115](#)
 DSP_PARAMETERS_U32.DSP_RAW_PLUS_FFT_SUPPORTED (*C enumerator*), [115](#)
 DSP_WINDOW_ITEMS (*C enum*), [108](#)
 DSP_WINDOW_ITEMS.DSP_WINDOW_BARTLETT (*C enumerator*), [109](#)
 DSP_WINDOW_ITEMS.DSP_WINDOW_BLACKMAN (*C enumerator*), [108](#)
 DSP_WINDOW_ITEMS.DSP_WINDOW_BLACKMAN_HARRIS (*C enumerator*), [109](#)
 DSP_WINDOW_ITEMS.DSP_WINDOW_HAMMING (*C enumerator*), [108](#)
 DSP_WINDOW_ITEMS.DSP_WINDOW_HANNING (*C enumerator*), [108](#)
 DSP_WINDOW_ITEMS.DSP_WINDOW_NONE (*C enumerator*), [108](#)

F

FFT_FOOTER (*C enum*), [137](#)
 FFT_FOOTER.FFT_FOOTER_NONE (*C enumerator*), [137](#)
 FFT_FOOTER.FFT_FOOTER_NPT (*C enumerator*), [137](#)
 FFT_OUTPUT_FORMAT (*C enum*), [136](#)
 FFT_OUTPUT_FORMAT.FFT_OUTPUT_FORMAT_FLOAT_AMP2 (*C enumerator*), [137](#)
 FFT_OUTPUT_FORMAT.FFT_OUTPUT_FORMAT_FLOAT_LOG (*C enumerator*), [137](#)
 FFT_OUTPUT_FORMAT.FFT_OUTPUT_FORMAT_S32_IMAG (*C enumerator*), [137](#)
 FFT_OUTPUT_FORMAT.FFT_OUTPUT_FORMAT_S32_REAL (*C enumerator*), [137](#)
 FFT_OUTPUT_FORMAT.FFT_OUTPUT_FORMAT_U8_AMP2 (*C enumerator*), [136](#)
 FFT_OUTPUT_FORMAT.FFT_OUTPUT_FORMAT_U8_LOG (*C enumerator*), [136](#)
 FFT_OUTPUT_FORMAT.FFT_OUTPUT_FORMAT_U16_AMP (*C enumerator*), [137](#)
 FFT_OUTPUT_FORMAT.FFT_OUTPUT_FORMAT_U16_AMP2 (*C enumerator*), [136](#)
 FFT_OUTPUT_FORMAT.FFT_OUTPUT_FORMAT_U16_LOG (*C enumerator*), [136](#)
 FFT_OUTPUT_FORMAT.FFT_OUTPUT_FORMAT_U32_AMP2 (*C enumerator*), [136](#)

R

- RETURN_CODE (C enum), 118
- RETURN_CODE.ApiAccessDenied (C enumerator), 118
- RETURN_CODE.ApiAcquisitionModeOnlySupportedInFifoStreaming (C enumerator), 124
- RETURN_CODE.ApiAdcJesdLinkNotLocked (C enumerator), 125
- RETURN_CODE.ApiAdcJesdPllNotLocked (C enumerator), 125
- RETURN_CODE.ApiBufferNotReady (C enumerator), 121
- RETURN_CODE.ApiBufferOverflow (C enumerator), 121
- RETURN_CODE.ApiBufferTooSmall (C enumerator), 121
- RETURN_CODE.ApiBusy (C enumerator), 124
- RETURN_CODE.ApiConfigAccessFailed (C enumerator), 119
- RETURN_CODE.ApiDESOnlySupportedInSingleChannelMode (C enumerator), 122
- RETURN_CODE.ApiDmaChannelInvalid (C enumerator), 118
- RETURN_CODE.ApiDmaChannelTypeError (C enumerator), 118
- RETURN_CODE.ApiDmaChannelUnavailable (C enumerator), 118
- RETURN_CODE.ApiDmaCommandInvalid (C enumerator), 119
- RETURN_CODE.ApiDmaDone (C enumerator), 118
- RETURN_CODE.ApiDmaInProgress (C enumerator), 118
- RETURN_CODE.ApiDmaNotPaused (C enumerator), 118
- RETURN_CODE.ApiDmaPaused (C enumerator), 118
- RETURN_CODE.ApiDmaPending (C enumerator), 121
- RETURN_CODE.ApiDmaSglBuildFailed (C enumerator), 121
- RETURN_CODE.ApiDoNothing (C enumerator), 121
- RETURN_CODE.ApiDspFiniteRecordsPerAcquisition (C enumerator), 123
- RETURN_CODE.ApiError1 (C enumerator), 123
- RETURN_CODE.ApiError2 (C enumerator), 123
- RETURN_CODE.ApiFailed (C enumerator), 118
- RETURN_CODE.ApiFastBufferLockCountExceeded (C enumerator), 124
- RETURN_CODE.ApiFftSizeTooLarge (C enumerator), 123
- RETURN_CODE.ApiFileIoError (C enumerator), 122
- RETURN_CODE.ApiFpgaJesdLinkNotLocked (C enumerator), 125
- RETURN_CODE.ApiGPUError (C enumerator), 124
- RETURN_CODE.ApiHardwareRemoved (C enumerator), 125
- RETURN_CODE.ApiHSNotSupported (C enumerator), 120
- RETURN_CODE.ApiInconsistentChannel (C enumerator), 123
- RETURN_CODE.ApiInsufficientResources (C enumerator), 120
- RETURN_CODE.ApiInterleaveNotSupportedInTraditionalMode (C enumerator), 124
- RETURN_CODE.ApiInvalidAccessType (C enumerator), 119
- RETURN_CODE.ApiInvalidAddress (C enumerator), 119
- RETURN_CODE.ApiInvalidBuffer (C enumerator), 121
- RETURN_CODE.ApiInvalidClockFrequency (C enumerator), 122
- RETURN_CODE.ApiInvalidData (C enumerator), 121
- RETURN_CODE.ApiInvalidDeviceInfo (C enumerator), 119
- RETURN_CODE.ApiInvalidDriverVersion (C enumerator), 121
- RETURN_CODE.ApiInvalidDspModule (C enumerator), 122
- RETURN_CODE.ApiInvalidFirmwareForATS4001 (C enumerator), 125
- RETURN_CODE.ApiInvalidFirmwareForATS9364 (C enumerator), 125
- RETURN_CODE.ApiInvalidHandle (C enumerator), 120
- RETURN_CODE.ApiInvalidIndex (C enumerator), 119
- RETURN_CODE.ApiInvalidInputRange (C enumerator), 124
- RETURN_CODE.ApiInvalidIopSpace (C enumerator), 119
- RETURN_CODE.ApiInvalidLicense (C enumerator), 120

[tor](#)), [125](#)
 RETURN_CODE.ApiInvalidNptFooter (*C enumerator*), [123](#)
 RETURN_CODE.ApiInvalidOffset (*C enumerator*), [120](#)
 RETURN_CODE.ApiInvalidPciSpace (*C enumerator*), [119](#)
 RETURN_CODE.ApiInvalidPowerState (*C enumerator*), [120](#)
 RETURN_CODE.ApiInvalidRecordsPerBuffer (*C enumerator*), [121](#)
 RETURN_CODE.ApiInvalidRegister (*C enumerator*), [119](#)
 RETURN_CODE.ApiInvalidSize (*C enumerator*), [119](#)
 RETURN_CODE.ApiInvalidSkipTable (*C enumerator*), [122](#)
 RETURN_CODE.ApiInvalidStateDoRetry (*C enumerator*), [124](#)
 RETURN_CODE.ApiLockAndProbePagesFailed (*C enumerator*), [122](#)
 RETURN_CODE.ApiNetworkError (*C enumerator*), [123](#)
 RETURN_CODE.ApiNoAction (*C enumerator*), [120](#)
 RETURN_CODE.ApiNoActiveDriver (*C enumerator*), [119](#)
 RETURN_CODE.ApiNoRcPathVariable (*C enumerator*), [124](#)
 RETURN_CODE.ApiNotEnoughNptFooters (*C enumerator*), [123](#)
 RETURN_CODE.ApiNotInitialized (*C enumerator*), [120](#)
 RETURN_CODE.ApiNotSupportedInDualChannelMode (*C enumerator*), [122](#)
 RETURN_CODE.ApiNotSupportedInQuadChannelMode (*C enumerator*), [122](#)
 RETURN_CODE.ApiNotSupportThisChannel (*C enumerator*), [120](#)
 RETURN_CODE.ApiNullParam (*C enumerator*), [119](#)
 RETURN_CODE.ApiOCTIgnoreBadClockNotSupported (*C enumerator*), [123](#)
 RETURN_CODE.ApiOCTNoTriggerDetected (*C enumerator*), [123](#)
 RETURN_CODE.ApiOCTTriggerTooFast (*C enumerator*), [123](#)
 RETURN_CODE.ApiOnFpgaFftOptionMissing (*C enumerator*), [125](#)
 RETURN_CODE.ApiPciTimeout (*C enumerator*), [120](#)
 RETURN_CODE.ApiPllNotLocked (*C enumerator*), [122](#)
 RETURN_CODE.ApiPMNotSupported (*C enumerator*), [121](#)
 RETURN_CODE.ApiPowerDown (*C enumerator*), [120](#)
 RETURN_CODE.ApiRecordFootersNotSupported (*C enumerator*), [124](#)
 RETURN_CODE.ApiRecordHeadersNotSupported (*C enumerator*), [124](#)
 RETURN_CODE.ApiReferenceClockPllNotLocked (*C enumerator*), [125](#)
 RETURN_CODE.ApiSuccess (*C enumerator*), [118](#)
 RETURN_CODE.ApiTransferComplete (*C enumerator*), [122](#)
 RETURN_CODE.ApiUnsupportedFunction (*C enumerator*), [119](#)
 RETURN_CODE.ApiVpdNotEnabled (*C enumerator*), [120](#)
 RETURN_CODE.ApiWaitCanceled (*C enumerator*), [121](#)
 RETURN_CODE.ApiWaitTimeout (*C enumerator*), [121](#)